

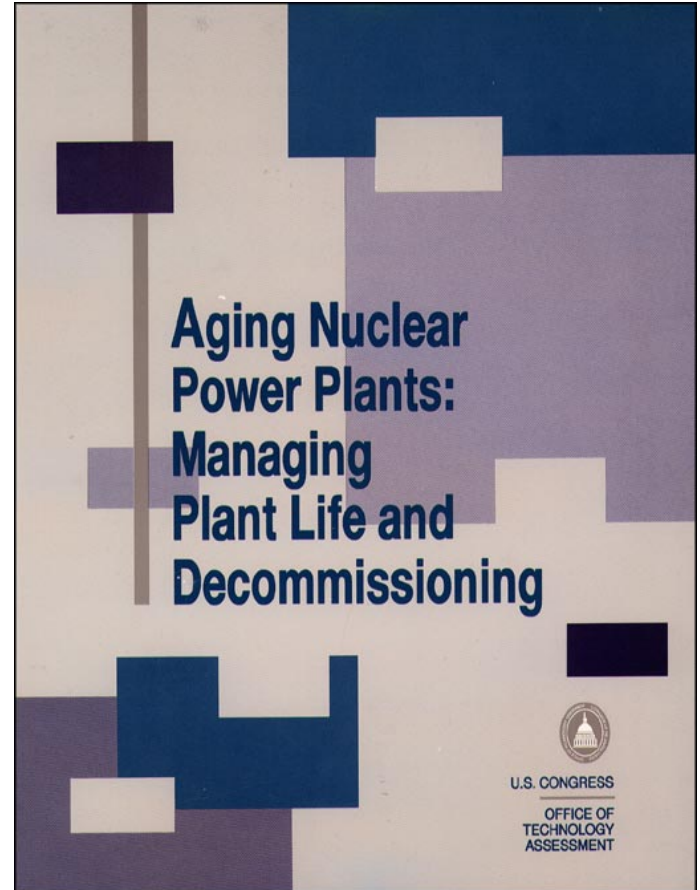
*Aging Nuclear Power Plants: Managing  
Plant Life and Decommissioning*

September 1993

OTA-E-575

NTIS order #PB94-107588

GPO stock #052-003-01342-8



Recommended Citation:

U.S. Congress, Office of Technology Assessment, *Aging Nuclear Power Plants: Managing Plant Life and Decommissioning*, OTA-E-575 (Washington, DC: U.S. Government Printing Office, September 1993).

# Foreword

Currently, 107 operating nuclear power plants supply over 20 percent of the Nation's electricity. As these plants age, issues related to plant lives and decommissioning are likely to become much more visible and draw more public attention. This report examines the following: the outlook for safety management and economic life decisions for the Nation's existing nuclear power plants as they age, the prospects for decommissioning, and current and potential Federal efforts that could contribute to more timely and better informed decisions regarding plant life and decommissioning. This report is a product of a request by the Senate Committee on Governmental Affairs and the House Committee on Energy and Commerce and its Subcommittee on Energy and Power.

After many years of intensive efforts by the U.S. Nuclear Regulatory Commission and the nuclear power industry, no insurmountable industry-wide safety challenges related to plant aging have been identified. There are some notable uncertainties for the longer term, however, that require ongoing research and experience to address. More immediately, many nuclear power plants already face severe economic pressures in the increasingly competitive electric power industry. Regarding decommissioning, experience with decommissioning small reactors and with major maintenance activities at large plants suggests that the task can be performed with existing technologies. However, several issues such as waste disposal and site cleanup standards remain unresolved.

OTA appreciates the substantial assistance received from many organizations and individuals in the course of this study. Members of the advisory panel provided helpful guidance and advice. Reviewers of the draft report contributed greatly to its accuracy and completeness. Personnel at the case study facilities shared their valuable experiences and perspectives. To all of them goes the gratitude of OTA and the personal thanks of the project staff.



Roger C. Herdman, Director

# Advisory Panel

**Richard E. Schuler, *Chairman***  
Cornell University

**Peter Bradford**  
New York Public Service  
Commission

**Richard W. DeVane**  
Framatome USA, Inc.

**William Dornsife**  
Pennsylvania Department of  
Environmental Resources

**S. David Freeman**  
Sacramento Municipal  
Utility District

**Michael W. Golay**  
Massachusetts Institute of  
Technology

**Jerome Goldberg**  
Florida Power and Light Co.

**Howard Hiller**  
Salomon Brothers

**David G. Heel**  
Medical University of South  
Carolina

**Leonard Hyman**  
Merrill Lynch Capital Markets

**James Joosten**  
Organization for Economic  
Cooperation and Development/  
Nuclear Energy Agency

**George J. Konzek**  
Pacific Northwest Laboratory

**Martin J. Pasqualetti**  
Arizona State University

**Robert Pollard**  
Union of Concerned Scientists

**Dan W. Reicher\***  
Natural Resources Defence Council

**Cas Robinson**  
National Association of Regulatory  
Utility Commissioners  
formerly, Georgia Public Service  
Commission

**John J. Taylor**  
Electric Power Research Institute

**H. B. Tucker**  
Duke Power Co.

**Nat Woodson**  
Westinghouse Electric Corp.

● Resigned winter 1993 to accept a position with U.S. Department of **Energy**.

NOTE: OTA appreciates and is grateful for the valuable assistance and thoughtful critiques provided by the advisory panel members, **The** panel does **not**, however, necessarily approve, disapprove, or endorse this report. **OTA** assumes full responsibility for the report and the accuracy of its contents.

# Project Staff

**Peter Blair**

Assistant Director, OTA  
(beginning February 1993)  
Energy, Materials, and International  
Security Division

**Lionel S. Johns**

Assistant Director, OTA  
(until February 1993)  
Energy and Materials Program Manager

**Emilia Govan**

(beginning August 1993)  
Energy and Materials Program Manager

**Robin Roy**

Project Director

**Andrew Moyad**

Analyst

**CONTRACTORS**

**ABZ, Inc.**

Chantilly, VA

**ADMINISTRATIVE STAFF**

**Lillian Chapman**

Office Administrator

**Linda Long**

Administrative Secretary

**Tina Aikens**

Secretary

# Abbreviations

|          |   |          |   |
|----------|---|----------|---|
| ACRS:    | Advisory Committee on Reactor Safeguards            | INPO:    | Institute of Nuclear Power Operations                             |
| AEA:     | Atomic Energy Act of 1954, as Amended               | IPA:     | integrated plant assessment                                       |
| ALARA:   | as low as is reasonably achievable                  | IPE:     | individual plant examinations                                     |
| ARDUTLR: | age-related degradation unique to license renewal   | IRP:     | integrated resource planning                                      |
| ASCE:    | American Society of Civil Engineers                 | ISFSI:   | independent spent fuel storage installation                       |
| ASME:    | American Society of Mechanical Engineers            | LLRWPAA: | Low-Level Radioactive Waste Policy Amendments Act of 1985         |
| BRC:     | below regulatory concern                            | LLW:     | low-level radioactive waste                                       |
| B&WOG:   | Babcock and Wilcox Owners' Group                    | MRS:     | monitored retrievable storage for spent nuclear fuel              |
| BWR:     | boiling water reactor                               | NDE:     | nondestructive examination  |
| CAAA:    | Clean Air Act Amendments of 1990                    | NERC:    | North American Electric Reliability Council                       |
| CF:      | capacity factor                                     | NPAR:    | NRC's Nuclear Plant Aging Research program                        |
| CLB:     | current licensing basis                             | NRC:     | U.S. Nuclear Regulatory Commission                                |
| DOE:     | U.S. Department of Energy                           | NUMARC:  | Nuclear Management and Resources council                          |
| DSM:     | demand-side management                              | NWPA:    | Nuclear Waste Policy Act of 1982                                  |
| EEI:     | Edison Electric Institute                           | O&M:     | operating and maintenance   |
| EIA:     | U.S. Energy Information Administration              | PNL:     | Pacific Northwest Laboratory                                      |
| EPA:     | U.S. Environmental Protection Agency                | POL:     | possession-only license   |
| EPACT:   | Energy Policy Act of 1992                           | PRA:     | probabilistic risk assessment                                     |
| EPRI:    | Electric Power Research Institute                   | PWR:     | pressurized water reactor   |
| EQ:      | environmental qualification of electrical equipment | RPV:     | reactor pressure vessel   |
| FERC:    | Federal Energy Regulatory Commission                | SALP:    | systematic assessment of licensee performance                     |
| GSI:     | generic safety issue                                | SOC:     | statement of considerations accompanying a promulgated regulation |
| IAEA:    | International Atomic Energy Agency                  | SSCs:    | systems, structures, and components                               |
| ICRP:    | International Commission on Radiological Protection |          |   |
| IEEE:    | Institute of Electrical and Electronics Engineers   |          |   |

*(for additional abbreviations see index)*

# Contents

## 1 Overview and Policy Issues 1

- Summary of Policy Issues 2
- Understanding and Managing Aging 6
- Aging and Safety 10
- Economy of Existing Plants 20
- After Retirement: Decommissioning 29

## 2 Safety of Aging Nuclear Plants 37

- Institutions for Assuring the Safety of Aging Plants 44
- Safety Practices Addressing Aging 47
- Health and Safety Goals for Aging Plants 61

## 3 Economic Lives of Existing Nuclear Plants 73

- The* Changing Electric Utility Context 73
- Institutional Issues in Nuclear Plant Economic Life Decisions 81
- Economic Performance of Nuclear Plants 86
- Factors Affecting Future Cost and Performance 92

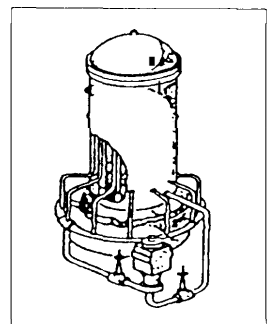
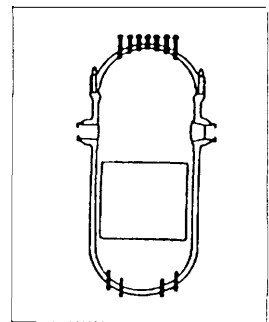
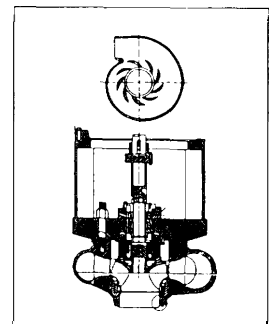
## 4 Decommissioning Nuclear Power Plants 101

- Residual Radioactivity Standards: How Clean is Clean Enough? 102
- Radioactive Waste Disposal 108
- Experience to Date 118
- Estimating Costs and Radiation Exposures 132
- Reactor Retirement and Financial Requirements 141

## 5 Case Studies of Nine Operating Plants 149

- Calvert Cliffs Case Study (2 plants) 150
- Hope Creek Case Study 156
- Monticello Case Study 160
- Salem Case Study (2 plants) 165
- SONGS Case Study (3 plants) 170

**Index 179**



# Reviewers and Contributors

**Edward C. Abbott**

ABZ, Inc.

**Satish K. Aggarwal**

U.S. Nuclear Regulatory Commission

**James V. Bailey**

Public Service Electric and Gas Co.

**Lake Barrett**

U.S. Department of Energy

**Stewart Brown**

U.S. Nuclear Regulatory Commission

**Nick Capik**

ABZ, Inc.

**John Carey**

Electric Power Research Institute

**Tom Champion**

Consolidated Edison Company

**Donald A. Cool**

U.S. Nuclear Regulatory Commission

**John W. Craig**

U.S. Nuclear Regulatory Commission

**Quresh Z. Dahodwala**

public Service Electric and Gas Co.

**Barth W. Doroshuk**

Baltimore Gas and Electric Company

**C. Gibson Durfee, Jr.**

Westinghouse Electric Corporation

**Richard Ferriera**

Sacramento Municipal Utility District

**Michael Finkelstein**

U.S. Nuclear Regulatory Commission

**Carl V. Giacomazzo**

Long Island Power Authority

**Dennis Harrison**

U.S. Department of Energy

**Donald W. Edwards**

Yankee Atomic Electric Co.

**James G. Hewlett**

U.S. Energy Information  
Administration

**Earl Hill**

Halliburton NUS

**L.M. Hill**

Shoreham Nuclear Power Station

**Mark Holt**

Congressional Research Service

**Seyavash Karimian**

Public Service Electric and Gas Co.

**Doris Kelley-Alston**

Merrill Lynch Capital Markets

**Robert M. Kinosian**

California Public Utilities Commission

**Jim Krauss**

Westinghouse Electric Co.

**Thomas LaGuardia**

TLG Services, Inc.

**Mike Niehoff**

Westinghouse Electric Corp.

**Philip A. Olson**

U.S. General Accounting Office

**Ed Parsons**

Scientific Ecology Group

**George Parkins**

Colorado public Utility Commission

**James S. Perrin**

Public Service Electric and Gas Co.

**Mark Petitclair**

Northern States Power Co.

**Terry Pickens**

Northern States Power Co.

**Robert M. Quillin**

Colorado Department of Health

**Harold B. Ray**

Southern California Edison Co.

**German Reyes**

Office of Technology Assessment

**Steve Reynolds**

U.S. Nuclear Regulatory Commission

**Geoffrey Rothwell**

Stanford University

**Gregory D. Schmalz**

Public Service Company of Colorado

**Joanne Seder**

Office of Technology Assessment

**Larry Shao**

U.S. Nuclear Regulatory Commission

**Ron Simard**

Nuclear Management and Resources  
council

**John Taylor**

Brookhaven National Lab

**Steve Trovato**

Consolidated Edison Company

**Gary Vine**

Electric Power Research Institute

**Richard Vollmer**

U.S. Nuclear Regulatory Commission

**Joseph J. Wambold**

Southern California Edison Co.

**Joseph C. Wang**

U.S. Nuclear Regulatory Commission

**Don Warembourg**

Public Service Company of Colorado

**Seymour Weiss**

U.S. Nuclear Regulatory Commission

**Robert Whitaker**

New York State Public Service  
Commission



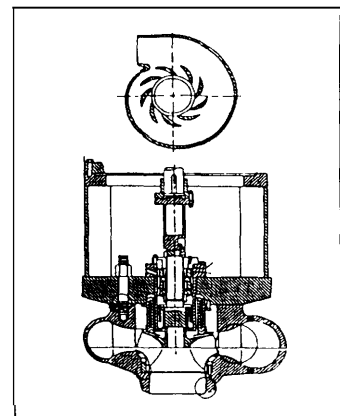
# Overview and Policy Issues | 1

**L**ong-term prospects for the Nation's 107 operating nuclear power plants are increasingly unclear. Proponents argue that these plants, which supply over 20 percent of the Nation's electricity, are vital to reliable, economic electricity supplies; have environmental benefits (e.g., they emit no greenhouse gases such as carbon dioxide); and reduce dependence on imported oil. Opponents, however, argue that nuclear plants bring risks of catastrophic accident, create unresolved waste disposal problems, and are often uneconomic. As these plants age, issues related to plant lives and decommissioning are likely to become much more visible and draw more public attention.

The past few years brought unexpected developments for nuclear plant lives and decommissioning. Since 1989, six nuclear power plants have been retired early, well before the expiration of their NRC operating licenses.<sup>1</sup> Owners of several other plants are investigating the economics of early retirement as well. The owners of the frost large commercial nuclear power plants planned for decommissioning anticipate costs much greater than estimates made only a few years earlier. And after a several year effort, the two lead plants in a program to demonstrate the NRC's plant license renewal process halted or indefinitely deferred their plans to file an application-in one case as part of an early retirement decision. While work continues to develop and eventually demonstrate a regulatory process for license renewal, it will be several years before the first application is filed and acted on. Absent license renewal, about 3 dozen operating nuclear power plants will have to retire in the next 20 years.

---

<sup>1</sup>In this report, the term early retirement refers to plant closure prior to expiration of the operating license issued by the NRC.



Despite these substantial challenges, there has also been good news for the U.S. nuclear industry recently. Reversing a decades long trend of rapid growth, average nuclear power plant operating and maintenance costs have decreased in recent years. Average plant reliability and availability have improved substantially. Safety performance has also been good. There have been no core damage accidents since Three Mile Island in 1979, nor an abnormal number and severity of events that could have led to core damage, much less any actual offsite releases of large amounts of radioactivity. Average occupational radiation exposures, already well below NRC limits, also declined substantially.

The Federal Government has a longstanding role in supporting a safe, environmentally sound, and economic supply of electricity for the Nation. Given the recent unexpected developments for existing nuclear power plants, this report, requested by the Senate Committee on Governmental Affairs and the House Committee on Energy and Commerce, examines the following:

- the outlook for the Nation's existing nuclear power plants as they age, focusing on safety management (ch. 2) and economy (ch. 3) during their remaining operating lives;
- the outlook for decommissioning (ch. 4); and
- Federal policies that could help address economic and safety issues for existing nuclear power plants as they age and as they are decommissioned (ch. 1).

### SUMMARY OF POLICY ISSUES

Current and planned nuclear power plant aging management practices are designed to identify and address challenges before they become a threat and to provide a reasonable assurance of adequate safety. These practices depend heavily on elaborate plant maintenance programs and ongoing research. There will always remain some risk, however, and continued industry and Federal regulatory vigilance is crucial. Attention to aging issues is crucial not just in considering license

renewal but in a plants original license term as well.

The industry and the NRC are working to address aging safety issues, but their efforts could be accelerated to determine better the long-term prospects for existing plants and to assure adequate long-term safety. For example, the NRC could intensify its review of aging safety research for possible regulatory applications. Greater attention to aging safety issues during a plant's original license term could also help justify a substantial simplification of the NRC's still-undemonstrated license renewal process.

Many nuclear power plants face severe economic pressures. The six early retirements occurring between 1989 and early 1993 give a sense of the variety of plant-specific issues likely to be involved in the future, as economic life decisions are made (box 1-A). In three of these decisions, aging issues played a prominent role. Other factors besides aging degradation and its effects on long-term safety and economy have played prominent roles in determining plant lives and will continue to do so in the future. Other important factors include: rising operational costs; disposal of radioactive waste (discussed below); public attitudes toward nuclear power (box 1-B); and the changing electric industry context, including increased competition and attention to environmental externalities.

Responsibility for judging a plant's economic attractiveness lies primarily with the owning utility and State regulators. The Federal role is relatively indirect. However, Federal activities such as spent fuel disposal, safety regulation, and policies addressing oil import security, global climate change, and other environmental challenges can all have major economic impacts both directly and as they affect the judgments of other interested parties.

While future economic conditions are highly uncertain, some analysts have suggested that as many as 25 plants may be retired in the coming decade. However, the economy of most nuclear power plants appears at least moderately attrac-

### Box 1-A—Taking Early Retirement: Recent Nuclear Power Plant Closures

Six **commercial nuclear** power plants in the United States have shutdown permanently since 1989, all well before their operating licenses were due to expire. The reasons behind these closures vary and are summarized briefly here.

#### Rancho Seco

This 873 MW pressurized water reactor (PWR) operated almost 15 years. The operating license was issued to the Sacramento Municipal Utility District (SMUD) on August 16, 1974. The plant was shut down on June 7, 1989 by a local voter referendum. The basis of the referendum was public concern about plant safety coupled with poor economic performance.

#### Shoreham

After years of construction delays, cost overruns, and legal and political battles, the 819 MW boiling water reactor (BWR) received a full power operating license on April 21, 1989. For several years, the State of New York had refused to accept the emergency evacuation plan proposed by the plant operator, the Long Island Lighting Co. (LILCO). The State argued that the population living near the plant was too large to evacuate quickly enough during an accident. As a result, just 2 months before receiving its operating license, on February 28, LILCO agreed to sell the plant to the State for decommissioning. The utility had pursued the full-power license to demonstrate the reactor was operable. In preparation for full-power operations, Shoreham was tested intermittently at low power between July 1985 and June 1987. Final shut down was on June 28, 1989, and the average fuel burnup in its brief life was the equivalent of about 2 days of full-power operation.

#### Fort St. Vrain

The Fort St. Vrain Nuclear Generating Station is a 330 MW high-temperature gas-cooled reactor owned by the Public Service Co. of Colorado. Although the operating license was issued December 21, 1973, this unique reactor operated only from 1979 to 1989. The plant was permanently closed August 18, 1989 due to several concerns: problems with the control rod drive assemblies and the steam generator ring headers, low plant availability (only about 15 percent), and prohibitive fuel costs. The plant operator became the first commercial nuclear utility to receive a possession-only license from the NRC since the Commission adopted decommissioning rules in 1988.

#### Yankee Rowe

This 185 MW PWR operated 30 years. The plant began commercial operations on July 1, 1961. On October 1, 1991, the reactor was taken offline for a combination of safety reasons and officially retired for related economic reasons on February 26, 1992. During its review of license renewal efforts, the NRC questioned the extent and impact of possible age-related embrittlement of the reactor pressure vessel (RPV). The plant owners estimated that demonstrating the adequacy of the RPV to the NRC's satisfaction would cost at least \$23 million and possibly more since no agreement had been reached on what would constitute a demonstration of adequacy. Yankee Rowe also faced previously unexpected poor economic prospects caused by an economic downturn in New England that resulted in excess generating capacity and large amounts of lower cost competitive power, including much fueled by natural gas.

#### San Onofre

San Onofre Nuclear Generating Station Unit 1, a 410 MW PWR operated by Southern California Edison (SCE) Co., began commercial operation January 1, 1968. Under an agreement with the California Public Utilities Commission Division of Ratepayer Advocates (DRA), SCE retired the plant November 30, 1992, 12 years prior

*(Continued on next page)*

**Box 1-A—Taking Early Retirement: Recent Nuclear Power Plant Closures--(Continued)**

to its license expiration. The settlement was triggered by economic analyses of the costs and benefits of a 2-year, \$135-million capital additions program required at the plant. Steam generator degradation also had resulted in a modest lifetime capacity factor. The DRA concluded that the plant was uneconomic. Although SCE disagreed with that assessment, it opted for the retirement settlement rather than pursue either a further hearing process or assume the risks and rewards of plant operation.

**Trojan**

The most recent early nuclear plant retirement to date, the 1,175 MW PWR operated for about 16 years before closing permanently January 4, 1993; the operating license was issued November 21, 1975. The plant had been off line since November 9, 1992 due to age-related tube leaks in one of its steam generators. The licensee, Portland General Electric (PGE), decided earlier in 1992 to close the plant in 1996 rather than invest the estimated \$200 million needed to replace its steam generators. The recent tube leaks, however, coupled with uncertainty regarding future regulatory treatment of microflaws in the tubes, led to a final closure decision in January 1993. For several years, Oregonians repeatedly voted in State-wide referenda on whether to retire the plant. Although those referenda were defeated by large margins each time, these public campaigns put pressure on the nuclear plant that PGE did not have to face for its other generating resources.

**SOURCE:** Office of Technology Assessment, 1993.

tive, assuming the recent leveling of costs continues.

There is great diversity among plants and plant performance. Electricity market conditions across the country are also diverse and changing, making the long-term prospects for nuclear plant lives neither uniform nor clear. Thus, no single safety or economic development is likely to affect uniformly the future of the Nation's existing nuclear power plants. Any tendency to judge the industry by early retirements may give a misleadingly dim view of the remaining lives of other plants. Rather, the future of the existing plants are likely to be determined individually over time as individual conditions change based on a host of separate decisions of utilities, State utility commissions, and Federal regulators. Integrated resource planning (IRP) and other elaborate analyses performed by States and utilities to assess plant economics are likely to play a growing role in future decisions about whether to continue operating existing plants.

Several decommissioning issues remain unresolved, although work is ongoing to address them. Residual radioactivity standards, which will determine the level of cleanup necessary at retired plant sites, are under development at the NRC. Depending on their stringency, such standards could have substantial impacts on decommissioning timing and costs. There also remains substantial uncertainty in decommissioning costs and the adequacy of decommissioning financing in cases of early retirement or rapid cost escalation. Although decommissioning costs are uncertain and large if viewed as a one-time expense, they are not large relative to lifetime plant production costs. Greater use could be made of early retirements as case studies to learn about the prospects for decommissioning costs and performance. Perhaps of greatest importance, however, is the future disposal capacity and cost for radioactive waste. Estimated low-level waste disposal costs have increased tenfold in the past decade, and there has been limited progress in developing new disposal facilities.

### Box 1-B–Public Views and Existing Nuclear Power Plants

Public perceptions and preferences about the nature of risk and the willingness to incur different types of risk can be critical issues in determining the future role of existing nuclear power plants. Public views have played a role in some recent early retirement decisions (see Shoreham, Rancho Seco and Trojan descriptions in box 1 -A.) In all three cases, the public pressures were long-standing rather than recent developments. In two of those, the concerns were combined with troubled economic operating histories.

With regard to decommissioning, public concerns about site remediations standards maybe a significant factor in cleanup decisions. Under the current NRC framework, decommissioning will lead to license termination and the potential cessation of regulatory oversight suggesting that public concerns about health and safety protection may be as great or greater than during plant operations.

As is true for many modern enterprises, the risks and benefits of nuclear power plant operation are imperfectly understood by the public and, to a lesser degree, by the scientific community.<sup>1</sup> Public preferences and perspectives for different dimensions of risk appear related to several factors, including whether the risk is voluntary or imposed; involves low probability, catastrophic accidents, or frequent accidents of limited extent; is well understood scientifically **and by the public; is natural (e.g., radiation exposure from radon or sunlight) or technological** (radiation from nuclear power plant accidents); accompanies highly beneficial activities (e.g., are the alternatives to nuclear power preferable?); or is familiar or unfamiliar. From the perspective of public perception and acceptance, nuclear power has scored poorly on these counts.<sup>2</sup>

At the same time, the nuclear power industry notes that its national public opinion polls over the last several years have consistently found support for nuclear power. For example, in a 1992 poll three-quarters of the American public responded that nuclear power should play an important role in future U.S. energy supplies, and two-thirds of respondents agreed that the existing plants have served the country well.<sup>3</sup>

<sup>1</sup>Public perception of risk often varies significantly from the best scientific evidence. For example, some studies have found that public perceptions of risks from nuclear power plant operation are far higher than indicated by scientific and medical evidence.

<sup>2</sup>p. Slovic, "Perception of Risk From Radiation," N.K. Sinclair (ed.) *Proceedings Of the 25th Annual Meeting of the National Council on Radiation Protection and Measurements: No. 11. Radiation Protection T&y-the NCRP at Sixty Years* (Bethesda, MD: NCRP, 1990), pp. 73-97; and L.C. Gould et al., *Perceptions of Technological Risks and Benefits* (New York, NY: Russel Sage Foundation, 1988).

<sup>3</sup>A. s. Bisconti, "The Two Faces of Nuclear Energy: U.S. Public Opinion from the Forties to the Nineties," Speech delivered at the American Nuclear Society Annual Meeting, Nov. 18, 1992, *Vital Speeches of the Day*, Mar. 1, 1993, vol. 59, No. 10. pp. 317-318.

The nuclear plants currently in operation are generally larger and more contaminated than the plants decommissioned to date. However, experience with decommissioning small reactors and with major maintenance activities at large plants suggests that the task of decommissioning can be performed with existing technologies. Final decommissioning of all but a few very special cases will likely not be performed before early in the next century. Rather, most retired plants will go

through a waiting period of between 5 years and several decades, allowing short-lived isotopes to decay.

As with many other modern societal activities, decommissioning cannot provide absolute protection of public health and safety, even if all radionuclides associated with the plant are removed from a site. For example, there will be some radiological risks associated with the waste disposal site, and nonradiological transportation

Table 1-A—Federal Policy Considerations

---

|  |
|--|
| <b>Assuring adequate aging safety</b>                    |
| Accelerate ongoing aging-related safety activities       |
| Simplify the license renewal rule                        |
| Revise public participation provisions                   |
| Apply NRC's safety goal policy to aging Issues           |
| <b>Supporting economic decisions</b>                     |
| Address aging-related regulatory safety Issues           |
| Address federal obligations for nuclear waste            |
| Expand analyses of nuclear plant economics               |
| Cofund industry R&D for existing plant issues            |
| <b>Policy issues for decommissioning</b>                 |
| Revise goals for decommissioning timing and site release |
| Reconsider adequacy of decommissioning financing         |
| Clarify regulatory policies for low-level waste          |
| Use early retirements as decommissioning case studies    |

---

SOURCE: Office of Technology Assessment, 1993.

and occupational risks. Background radiation from other sources will also remain. The NRC has recently undertaken a process to revise residual radioactivity requirements for terminating a license. The NRC could extend this effort to examine alternatives to its current requirement of unrestricted site release. For example, because future exposures depend on land use (e.g., industrial, residential, or agricultural), the NRC could investigate different radiological standards matched to restricted land uses.

Several Federal policy considerations relating to plant safety and economy could potentially result in more timely and better informed plant life and decommissioning decisions. These are listed in table 1-A and are discussed in the three last sections of the chapter. First, the following section provides an overview of the current understanding and management of aging.

## UNDERSTANDING AND MANAGING AGING

### ■ Experience With Plant Aging

The number and size of nuclear power plants grew rapidly in the 1970s and 1980s. Twenty-five years ago, there were 11 nuclear power plants in the United States with an average capacity of about 180 MW and an average age of 5 years. As of 1993, the average age of the 107 operating U.S. nuclear power plants was about 17 years, with an average capacity of over 900 MW.<sup>2</sup> While there are operating nuclear power plants in all regions of the Nation except the Rocky Mountain States, most of the older units are in the Midwest and along the Atlantic seaboard States (see figure 1-1).

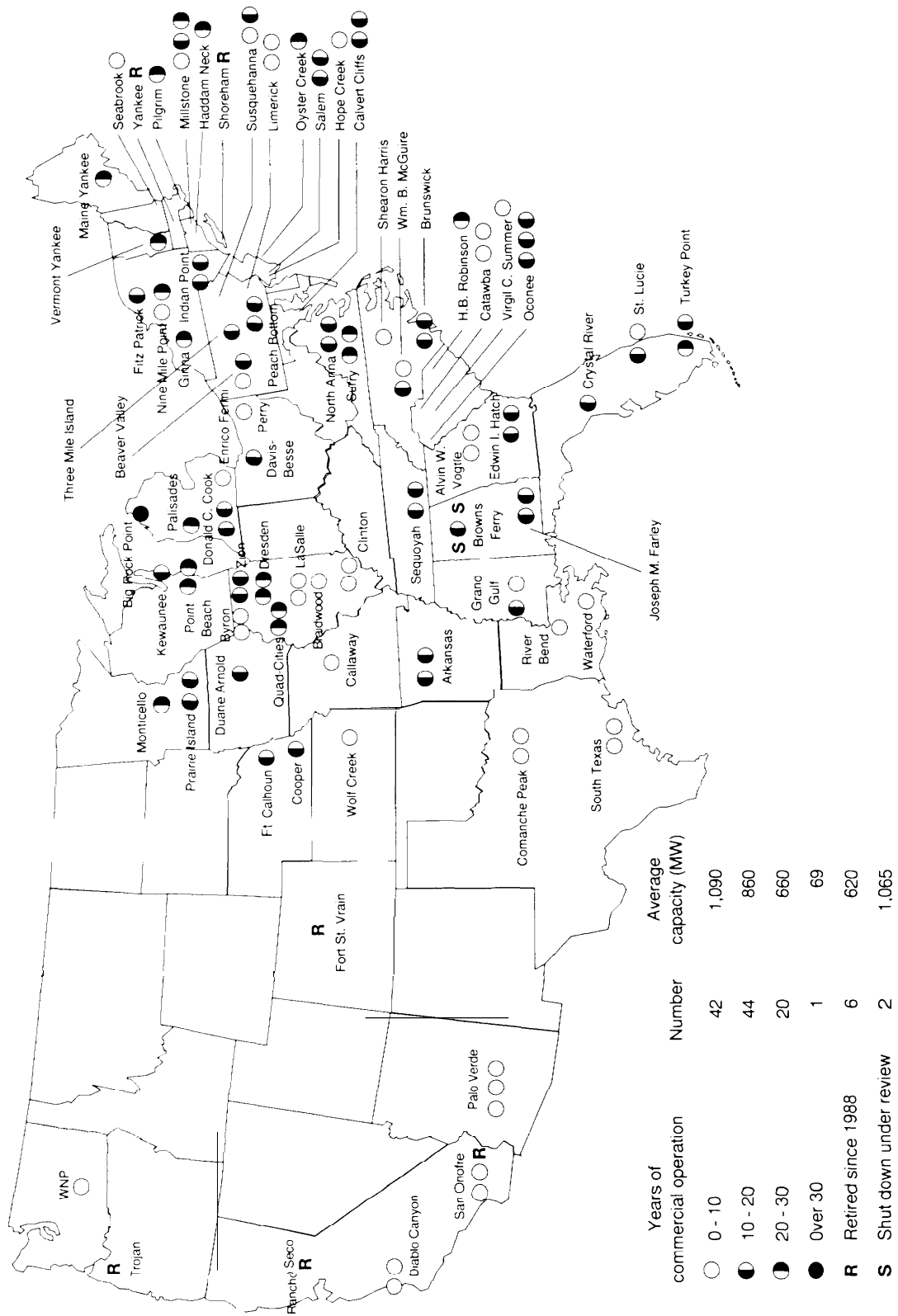
The number of plants outside the United States has grown rapidly as well. As of 1992, there were about 300 nuclear power plants in operation in 24 other countries. Although the United States has the largest number of nuclear power plants of any country, nuclear power supplies a larger fraction of total electricity in half of the other countries. Nuclear plants outside the United States tend to be newer, many of which have recently come into service. However, nuclear plant life management issues are being examined in the international community, for example, by the Organization of Economic Cooperation and Development, the International Atomic Energy Agency and by individual countries (see figure 1-2).<sup>3</sup> Worldwide, 22 new nuclear power plants began operation between 1990 and 1992, including one in the United States. During this period a similar number of plants were retired, the majority of which were in Germany and the former Soviet Union.

---

<sup>2</sup> Of the 11 plants operating 25 years ago, 2 remain in service. These are Big Rock Point, a 69 MW plant in Michigan, and Haddam Neck (also known as Connecticut Yankee), a 569 MW plant. U.S. Department of Energy, *Nuclear Reactors Built, Being Built, or Planned: 1991*, DOE/OSTI-8200-R55, July 1992, pp. 1-6, 23, 24.

<sup>3</sup> See, e.g., Organization of Economic Cooperation and Development/Nuclear Energy Agency, "Nuclear Power Plant Aging and Life Management: A Model Approach, Current Status, and Country Comparisons," draft, Nov. 3, 1992.

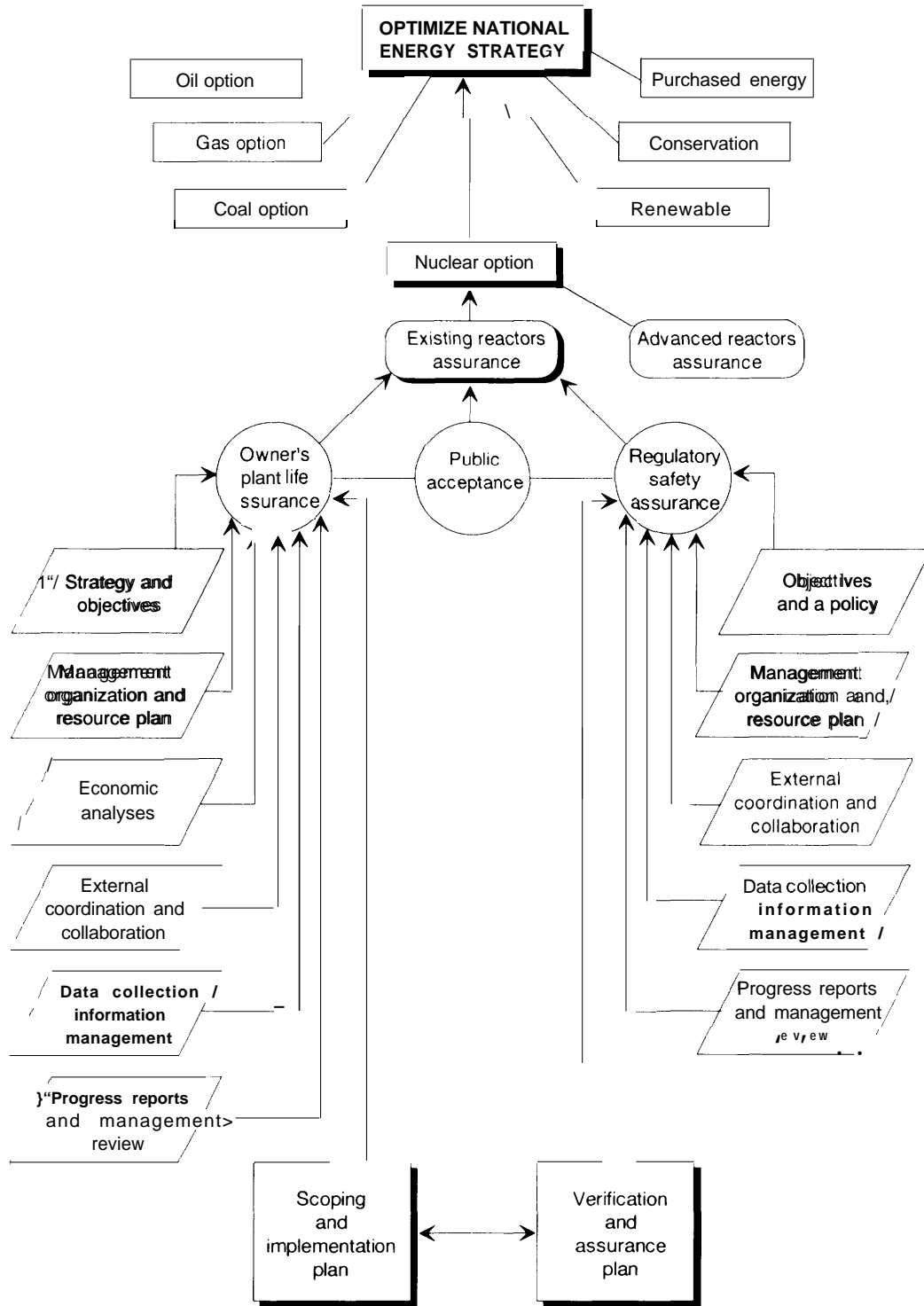
Figure 1-1—Commercial Nuclear Power Plants in the United States as of July 1993



SOURCE: Adapted from U.S. Nuclear Regulatory Commission, *Information Digest* (Washington, DC: USNRC, 1992).

## 8 | Aging Nuclear Power Plants: Managing Plant Life and Decommissioning

Figure 1-2—An International Framework for Nuclear Plant Life Management



SOURCE: Organization of Economic Cooperation and Development, Nuclear Power Plant Aging and Life Management: A Model Approach, Current Status, and Country Comparisons, draft, Nov. 3, 1992, p. 6.



### Box 1-C—What is Aging Degradation?

**Many systems, structures, and components (SSCs)** in industrial facilities, including nuclear power plants, are subject to aging degradation. For nuclear power plants, aging degradation is defined as the cumulative degradation that occurs with the passage of time in SSCs that can, if unchecked, lead to a loss of function and an impairment of safety.<sup>1</sup> The basic processes of aging are generally, if imperfectly, understood; continuing **experience and research provide ongoing improvements in scientific understanding and ability to predict and address the effects.**

Aging degradation can be observed in a variety of changes in physical properties of metals, concrete, and other materials in a power plant. These materials may undergo changes in their dimensions, ductility, fatigue capacity, mechanical or dielectric strength. Aging degradation results from a variety of aging mechanisms, physical or chemical processes such as fatigue, cracking, embrittlement, wear, erosion, corrosion, and oxidation. These **aging mechanisms** act on SSCs due to a challenging environment with high heat and pressure, radiation, reactive chemicals, and synergistic effects. Some operating practices such as power plant cycling (i.e., changing power output) and equipment testing can also create stress for plant SSCs.

There is a fairly limited set of degradation mechanisms, a large commonality in materials used, and fairly similar operating conditions. However, due to the diversity in plant designs, construction and materials used, operating conditions and histories, and maintenance practices, the specific effects of aging, although similar, are unique for each plant. Even near-twin units at the same site can have substantial differences in the remaining lives of major SSCs, based on subtle design or material differences and operating histories.

Among the major aging degradation issues for long-lived SSCs are:

- reactor pressure vessel embrittlement;
- steam generator tube corrosion and cracking;
- environmental qualification for in-containment cables and other electrical equipment; and
- fatigue, stress corrosion cracking, and other mechanisms that may affect a variety of metal components,

---

<sup>1</sup>U.S. Nuclear Regulatory Commission *Nuclear Plant Aging Research (NP/A?) Program Plan*, NUREG-1144 Rev. 2 (Washington, DC: June 1991).

Experience with and understanding of aging issues continue to increase (box 1-C). In total, the histories of the more than 400 nuclear plants provide several thousand reactor-years of operating experience with aging. However, because of the industry's youth, experience with nuclear power plants in the second half of their 40-year licensed lives is limited. This limited experience with aging can be particularly important for some major long-lived systems, structures, and components (SSCs) such as the reactor pressure vessel (RPV), cables, and containment structure that are intended to function for the full life of a facility.

Absent actual long-term operating experience for long-lived SSCs, understanding of aging issues involves engineering analyses and research, often using techniques to simulate accelerated aging on test materials. Retired plants may also yield lessons about aging by providing naturally aged SSCs for study. However, the diversity among plants and their SSCs prevents simple generalizations about the ultimate effects and management of aging. In contrast, many other components have relatively short lives (e.g., pumps and valves) and are periodically refurbished or replaced. For these shorter lived SSCs, engineering analyses and aging research are supported better by actual operating experience.

## ■ Managing Aging Degradation

Effective maintenance programs are crucial to manage aging degradation. Maintenance involves a variety of methods to predictor detect aging degradation and other causes of SSC failure, and to replace or refurbish any affected SSCs. New maintenance technologies include an array of improved hardware and procedures that can benefit the future management of aging degradation. To “ensure the continuing effectiveness of maintenance for the lifetime of nuclear power plants, particularly as plants age,” the NRC promulgated a maintenance rule in 1991 to become effective in 1996.<sup>4</sup> The Institute of Nuclear Power Operations (INPO), an industry organization established in 1979 to promote excellence in nuclear power plant operations, had previously developed guidelines for effective maintenance to guide utility practices.<sup>5</sup>

The process to manage aging is elaborate, beginning with plant design and construction, and continuing with maintenance and research. The SSCs that comprise a nuclear plant were designed to have sufficient design margins to meet specified minimum lifetime requirements. However, in the decades since many of today’s plants were first designed and built, extensive experience and research have shown that some SSCs degrade more rapidly than had been expected, while others last longer. Major examples of more rapid degradation are RPV embrittlement, steam generator tube degradation, and fatigue and stress corrosion cracking of piping. The NRC currently devotes about 20 percent of its \$100 million annual research budget to aging-related projects. The industry also performs extensive aging-related research. For example, since its inception in 1973, the Electric Power Research Institute (EPRI) has

devoted about 15 percent of its nuclear research budget (currently over \$100 million annually) to understand, detect, and mitigate degradation of nuclear power plant components.<sup>6</sup>

Based on research and experience, design standards have changed considerably since today’s oldest plants began operating. To assure the adequacy of older designs in the light of new technical information, the NRC and the industry have conducted extensive reviews (most notably through the NRC’s Systematic Evaluation Program of the late 1970s) and continue to do so. Two current examples of particular attention are the NRC’s efforts to examine environmental qualification of electrical equipment (EQ) and fatigue as generic safety issues. Factors such as fatigue, EQ, and embrittlement are more prominent for older plants, not so much because they have aged more, but because older plant designs and materials were based on less complete understanding of aging degradation than newer plants. Thus, younger plants may be presented with fewer challenges as they age. For those plants affected, the costs of addressing these issues may be substantial.

## AGING AND SAFETY

Under normal operating conditions, nuclear power plants cause limited and generally unmeasurable public health impacts. However, as evidenced by probabilistic risk assessments and occasional alarming operating events, existing nuclear power plants also pose a small risk of catastrophic accidents in which public injury or fatality could result. Absent effective aging management as discussed above, aging degradation increases the probability that any SSC will fail to

---

<sup>4</sup>10 CFR 50.65

<sup>5</sup> In promulgating the rule, the Nuclear Regulatory Commission noted that its recent inspections of maintenance activities found that existing programs were adequate and **improving**, but there were some areas of weaknesses, and no licensee had formally committed to implement the INPO standards prior to the rule’s proposal. 56 Federal Register 31321 (July 10, 1991).

<sup>6</sup> John Carey, Electric Power Research Institute, personal communication January 1993; and Electric Power Research Institute, *Research and Development Plan 1993* (Palo Alto, CA: 1993).

function properly, potentially leading to an accident.<sup>7</sup> Continued effort to manage aging at every plant is thus one important aspect of assuring safety. However, after many years of intensive efforts by the NRC and industry, no insurmountable, industry-wide safety challenges related to aging have been identified, although there are some notable uncertainties that research continues to address. Some aging-related safety issues such as more detailed re-examination of fatigue, EQ, and RPV embrittlement, and implementation of license renewal regulations will have effects on plant lives that are yet to be determined. Aside from plant aging challenges, the NRC and the industry continue to address other risks and uncertainties including the performance of human operators, and containment structures, and the potential impacts of external events such as earthquakes and flooding.

Some have suggested that the safety of older plants is inadequate because those plants were not designed with the same detailed guidance as newer plants and therefore often do not meet the current design standards.<sup>8</sup> It is true that a newly constructed plant identical to older plants could not be licensed under current NRC regulations. However, the NRC notes that it has judged and continues to judge the safety of older plants on an ad hoc and plant-specific basis (e.g., through the

Systematic Evaluation Program) rather than against standardized design requirements, and finds that adequate safety currently exists.

## ■ Institutional Efforts Determining the Adequate Safety of Aging Management

To assure the adequate protection of public health and safety in the use of nuclear power, the NRC performs a variety of regulatory activities to address aging and other issues under the Atomic Energy Act of 1954 as amended (AEA).<sup>9</sup> Each nuclear power plant has a unique set of NRC requirements established at initial licensing and modified over time to provide, in the judgment of the NRC, a reasonable assurance of adequate safety (box 1-D). This set of requirements is called the plant's current licensing basis (CLB).<sup>10</sup> Although the NRC plays a major role in assuring nuclear plant safety, the AEA assigns the primary responsibility for safe operation of a commercial nuclear plant not to the NRC but to the plant operator, or licensee.<sup>11</sup> Each licensee is ultimately responsible for the design, operation, and maintenance of its plant, not merely to meet NRC requirements, but to assure safety.

Given the complexity and often plant-specific nature of many technical issues, there are often differing opinions, not only about technical is-

---

<sup>7</sup> Nuclear plants are designed with the principle of "defense in depth," involving redundancy and multiple safety systems to mitigate the effects of any single failure. Thus, an accident involves a sequence of failures. One example of redundancy is in electrical supplies for critical safety systems, which include offsite electricity sources, emergency diesel generators, and alternate supplies such as emergency batteries. Another example is the multiple barriers designed to contain radioactive materials at successive locations, including the fuel matrix, fuel cladding, primary coolant circuit boundary, and the containment structure. Age-related degradation in the SSCS can affect each level of defense in depth to varying degrees.

<sup>8</sup> See, e.g., Diane Curran, counsel for the Union of Concerned Scientists, *Hearings Before the Subcommittee on Energy and the Environment of the Committee on Interior and Insular Affairs*, House of Representatives, Nov. 5, 1991, pp. 93-95.

<sup>9</sup> Atomic Energy Act of 1954 as amended (AEA), Public Law 83-703, 68 Stat. 919. The NRC was established by the Energy Reorganization Act of 1974 as an independent agency of the Federal Government. 42 United States Code Sec. 5841 *et seq.* Its regulatory responsibilities were transferred from the U.S. Atomic Energy Commission.

<sup>10</sup> This large body of requirements is contained in a plant's operating license application or Safety Analysis Report; plant specific compliance with Commission regulations noted in 10 CFR Part 50, as well as other parts of Title 10 of the Code of Federal Regulations; Commission orders, license conditions, exemptions and technical specifications; and all written commitments made by the licensee in docketed responses to NRC bulletins and generic letters.

<sup>11</sup> 42 U.S.C. 2011 *et seq.*

### Box 1-D-How Safe Is Safe Enough?

An underlying question in determining the adequacy of aging management is the overall goal for nuclear plant safety: “How safe is safe enough?” Absolute protection, that is, the total absence of risk, is neither possible nor a meaningful goal for nuclear power plants or any other energy source. The *Atomic Energy Act* provides little direction in answering the question of how safe is safe enough. Rather, it leaves that responsibility with the NRC under the general charge of assuring adequate protection of the public health and safety.

To address the issue of acceptable risk to the public, the NRC formally set qualitative safety goals for nuclear power plant operation in 1986, after several years of development, as well as quantitative objectives to be used in determining achievement of the goals.<sup>1</sup> For example, the policy states,

The risk to an average individual in the vicinity of a nuclear power plant of prompt fatalities that might result from reactor accidents should not exceed one-tenth of one percent (0.1 percent) of the sum of prompt fatality risks resulting from other accidents to which members of the U.S. population are generally exposed.

The best available information indicates that, if aging is properly managed, the risk of fatalities resulting from nuclear power plant operations in the United States is low relative to NRC’s safety objectives.

Although the safety goal policy can provide useful guidance in regulatory activities, it has some notable limitations, perhaps the greatest of which is the practical difficulty of translating the risk-based goals into regulatory practices. There is, however, a growing use of risk-based approaches, for example, in complying with the maintenance rule.<sup>2</sup> Other areas for potential improvement in the safety goal policy include: clarifying consistency with safety goals in other Federal law; establishing a practical correlation with risks of non-nuclear electricity resources; considering changing demographic characteristics near a plant more fully; discussing the appropriate use of cost-benefit analyses; and more explicitly treating the uncertainty inherent in risk estimation.

<sup>1</sup> U.S. Nuclear Regulatory Commission, 51 *Federal Register* 30028 *et seq.*, Aug. 21, 1986. As might\* expected, the NRC’s safety goals do not vary according to a plant’s age.

<sup>2</sup> See, e.g., U.S. Nuclear Regulatory Commission, *Regulatory Guide* 1.160, June 1993; and Yankee Atomic Electric Co., *Applications of PRA*, EPRI NP-7315 (Palo Alto, CA: Electric Power Research Institute, May 1991).

sues, but about the appropriate level of technical detail to consider in the regulatory process. In fact, many in the industry maintain that some NRC activities and requirements are unpredictable, costly, and unnecessary to assure an adequate level of public health and safety. Similarly, some nuclear critics maintain that at least some NRC activities are “contrary to Congress’ purpose of

assuring that operation of nuclear power plants will not pose an undue risk to the public health and safety.”<sup>12</sup> Some observers suggest that the regulatory process itself, including the role of the courts, is overly cumbersome, legalistic, and exacerbates uncertainty.<sup>13</sup> Others suggest that NRC policies have been too restrictive of public input in addressing important safety issues.<sup>14</sup>

<sup>12</sup> The Union of Concerned Scientists and the New England Coalition on Nuclear Pollution, testimony on the Proposed License Renewal Rule for Nuclear Power Plants at hearings before the House Subcommittee on Energy and the Environment of the Committee on Interior and Insular Affairs, Nov. 5, 1991.

<sup>13</sup> M. W. Golay, “How Prometheus Came to be Bound: Nuclear Regulation in America,” *Technology Review*, June/July 1980, pp. 29-39. Although the article was written some time ago, most of it remains pertinent today. Michael Golay, personal communication, January 1993.

<sup>14</sup> M. Adato, The Union of Concerned Scientists, *Safety Second: The NRC and America’s Nuclear Power Plants* (Indianapolis, IN: Indiana University Press, 1987). As one example, under 10 CFR 2.206, while the public may petition the NRC staff to initiate a proceeding, there are no provisions for appealing staff decisions either to the Commission or judicially. However, the Commission has in the past invoked at its discretion the power to review staff decisions upon receiving a petition from a public interest group. See U.S. Nuclear Regulatory Commission “In the Matter of Yankee Atomic Electric Company,” Memorandum and Order, 50.029, July 31, 1991.

Ultimately, although regulatory activities and industry practices for managing aging (and other safety-related issues) are based on detailed technical analyses, the determination of whether those practices provide adequate safety lies with the professional judgment of the NRC. In performing its task, the NRC is often aided by other parties including the nuclear industry, public interest groups, and State agencies. The industry established the Nuclear Management and Resources Council (NUMARC) in 1987 to coordinate interactions with the NRC on industry-wide regulatory issues. The NRC's process of issuing licenses and developing new rules and regulations is largely open, and public input is allowed, as required by the Administrative Procedures Act.<sup>15</sup> There have also been numerous cases of judicial review of NRC licensing and procedural decisions brought by the public and interest groups.

It should be noted that while the NRC and the commercial nuclear power industry have elaborate processes for addressing safety issues including aging, those processes have generally, but not always, performed as effectively as intended. The apparent failure of regulatory and industry processes with regard to the widely used fire retardant Thermo-Lag provides one example outside the area of aging.<sup>16</sup> However, such a failure appears the rare exception.

There are several aging-related examples of regulatory issues for which differing opinions and questions about the appropriate level of technical detail are yet to be resolved. Among them are regulatory activities addressing steam generator microflaws and RPV embrittlement, issues that

contributed to recent early retirement decisions at two plants. The owners of the plants, both of whom believed their plants to be safe, opted for retirement, citing in part the uncertain but high costs of meeting NRC requirements that were yet to be determined (see descriptions of the Yankee Rowe and Trojan retirement decisions in box 1-A.) Another major regulatory issue related to aging for which implementation and other issues remain to be resolved is license renewal, discussed below.

### ■ Aging Safety and License Renewal

As specified in the AEA, commercial nuclear plant operating licenses may not exceed 40 years, but may be renewed on expiration.<sup>17</sup> The fixed term was established in the AEA for financial and other nontechnical reasons, although once chosen, it became an assumption in specifying certain plant design features (e.g., the number of thermal cycles occurring, and thus the requirements for fatigue).

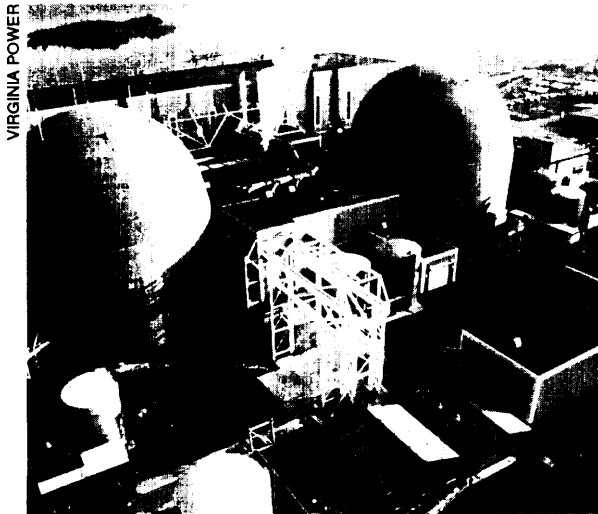
During the past few years, the NRC and the commercial nuclear power industry, with funding support from the U.S. Department of Energy (DOE), have devoted considerable effort to the topic of nuclear plant license renewal. Although the NRC promulgated its license renewal rule in 1991,<sup>18</sup> it will be several years before practical implementation guidance is finalized. The NRC's implementation effort includes developing a 'Regulatory Guide,' that instructs applicants in detail on the standard format for technical information, and a 'Standard Review Plan,' that instructs the NRC staff in detail on the framework for review-

<sup>15</sup> 5 U.S.C. Sec. 551 *et seq.* 'Subchapter II—Administrative Procedures.'

<sup>16</sup> As early as about 10 years ago when Thermo-Lag was certified as a fire retardant, several licensees raised concerns about the material's effectiveness with the NRC. However, the NRC did not act to examine those concerns until the early 1990s, by which time about 84 plants were using Thermo-Lag. Recently, the NRC Inspector General issued a report critical of the NRC's performance in that case, and a grand jury investigation has been initiated by the U.S. Attorney in Maryland.

<sup>17</sup> Of the other countries with large nuclear power programs, none have adopted fixed license terms. The absence of fixed license terms is one of a number of features that distinguishes U.S. nuclear regulatory practices from the international community. Organization for Economic Co-Operation and Development, Nuclear Energy Agency, *Licensing Systems and Inspection of Nuclear Installations 1991* (Paris, France: OECD 1991).

<sup>18</sup> 56 *Federal Register* 64943-64980 (Dec. 13, 1991).



*Virginia Power replaced the steam generators at its Surry units 1 and 2 (shown here) in 1979 and 1981, respectively. Virginia Power attributes the relatively low cost and rapid completion of the 1993 steam generator replacement at its North Anna unit one in part to the experience gained at Surry.*

ing an application. Both of these efforts remain in draft stages, which the NRC expects to finalize after gaining experience from the first few applicants or, “lead plants,” working through the process. The NRC has also proposed but not finalized a rule establishing requirements for the environmental review of license renewal applications, as required by the National Environmental Policy Act.<sup>19</sup> Even after the NRC acts on the early license renewal applications, there may be court

challenges to the implementation of the rule that would take additional time to resolve.

The inexperience with license renewal regulations is largely explained by the industry’s relative youth—with the exception of one small unit, the license of the oldest operating plant will not expire until 2007 (table 1-B). Although the licenses of several other younger plants expire sooner, a relatively simple NRC administrative procedure allows those plants to extend their expiration dates by the number of years spent during construction.<sup>20</sup> By 2015, however, license renewal would be required for continued operation of more than 40 other plants, over one-third of those now in operation.

By the end of 1992, early license renewal efforts at the two lead plants had been withdrawn or deferred. Owners of the Yankee Rowe and the Monticello plants originally planned to submit license renewal requests in 1991 as part of a jointly funded multiyear DOE/industry lead plant program. However, Monticello’s owners indefinitely deferred their license renewal application in late 1992 citing concern about the interpretation of the NRC’s rule, noting that the number of systems to be reviewed had grown from the original 74 to 104 with “no indication of where it might go from there.”<sup>21</sup> Also noted as major concerns were operational cost increases and lack of resolution in spent fuel disposal. As noted in box 1-A, Yankee Rowe’s owners chose early retirement in 1992 for economic reasons, including the cost of addressing NRC concerns about

<sup>19</sup> 56 *Federal Register* 47016.

<sup>20</sup> License terms were initially set based on the start of plant construction rather than the start of operation. However, NRC regulations allow a relatively simple procedure to recover the construction period and thereby extend expiration of the initial operating licenses without license renewal. The difference can be substantial. For example, the license for Unit 1 of the Diablo Canyon plant expires in 2008 based on approval of its construction license in 1968, although operation did not begin until 1984 following a series of construction delays. By recovering the construction period in the initial license, Diablo Canyon would require license renewal only in 2024, 16 years beyond the current expiration. For this reason, the year of expiration as currently shown for some licenses is not an accurate reflection of the date at which license renewal would be needed.

<sup>21</sup> J. Howard, Chief Executive Officer of Northern States power, cited in “License Renewal Suffers New Blow as NSP Application is ‘Deferred’,” *Nucleonics Week*, vol 33., No. 46, Nov. 12, 1992, pp. 1, 12, 13. The actual systems to be reviewed are not specified in the license renewal rule, and the NRC neither determined nor reviewed NSP’s lists of 74 and 104 systems. That is, the actual number of systems to be reviewed remained uncertain at the time NSP deferred its license renewal effort. See also, Northern States Power Co., “Perspectives on the License Renewal Process,” Nov. 20, 1992.

Table 1-B—U.S. Commercial Nuclear Power Operating License Expirations Through 2015

| Year <sup>a</sup><br>(Assuming<br>construction recapture) | Year (Under current<br>license, if different) | Name               | Generating capacity (MW) |                |                |      |
|---|---|--------------------|--------------------------|----------------|----------------|------|
| 2002  | 2000  | Big Rock Point     | 67                       |                |                |      |
| 2007  | 2007  | Haddam Neck        | 560                      |                |                |      |
| 2009  | 2004  | Oyster Creek 1     | 610                      |                |                |      |
|   |   | Dresden 2          | 772                      |                |                |      |
|   |   | Ginna              | 470                      |                |                |      |
|   |   | Nine Mile Point 1  | 615                      |                |                |      |
| 2010  |   | H.B. Robinson      | 683                      |                |                |      |
|   |   | Millstone 1        | 654                      |                |                |      |
|   |   | Monticello         | 536                      |                |                |      |
|   |   | Point Beach 1      | 485                      |                |                |      |
| 2011  | 2007  | Palisades          | 730                      |                |                |      |
|   |   | Dresden 3          | 773                      |                |                |      |
| 2012  | 2007  | Turkey Point 3     | 666                      |                |                |      |
|   |   | 2008               | Maine Yankee             | 860            |                |      |
|   |   |                    | Pilgrim 1                | 670            |                |      |
|   |   | Quad Cities 1      | 769                      |                |                |      |
|   |   | Quad Cities 2      | 769                      |                |                |      |
|   |   | Surry 1            | 781                      |                |                |      |
|   |   | Vermont Yankee     | 504                      |                |                |      |
|   |   | 2013               | 2007                     | Turkey Point 4 | 666            |      |
|   |   |                    |                          | 2008           | Peach Bottom 2 | 1055 |
|   |   |                    |                          |                | Fort Calhoun   | 478  |
| Indian Point 2  | 939   |                    |                          |                |                |      |
| Kewaunee  | 511   |                    |                          |                |                |      |
| Oconee 1  | 846   |                    |                          |                |                |      |
| Oconee 2  | 846   |                    |                          |                |                |      |
| Point Beach 2   | 485   |                    |                          |                |                |      |
| Prairie Island 1  | 503   |                    |                          |                |                |      |
| Surry 2   | 781   |                    |                          |                |                |      |
| 2014  | 2008  | Zion 1             | 1040                     |                |                |      |
|   |   | Zion 2             | 1040                     |                |                |      |
|   |   | Peach Bottom 3     | 1035                     |                |                |      |
|   |   | Arkansas Nuclear 1 | 836                      |                |                |      |
|   |   | Browns Ferry 2     | 1065                     |                |                |      |
|   |   | Brunswick 2        | 754                      |                |                |      |
|   |   | Calvert Cliffs 1   | 825                      |                |                |      |
|   |   | Cooper             | 764                      |                |                |      |
|   |   | D.C. Cook 1        | 1020                     |                |                |      |
|   |   | Duane Arnold       | 515                      |                |                |      |
|   |   | Edwin 1. Hatch 1   | 741                      |                |                |      |
|   |   | Fitzpatrick        | 780                      |                |                |      |
|   |   | Oconee 3           | 846                      |                |                |      |
|   |   | Prairie Island 2   | 500                      |                |                |      |
| Three Mile Island 1                                       | 808   |                    |                          |                |                |      |
| 2015  | 2009  | Indian Point 3     | 965                      |                |                |      |
|   |   | Millstone 2        | 863                      |                |                |      |

<sup>a</sup> Year of expiration assuming that the maximum number of years for construction recapture has been added to the current expiration date (i.e., 40 years from start of plant operation).

SOURCE: U.S. Nuclear Regulatory Commission, *Information Digest* 1992 cd., NUREG-1350 (Washington, DC: March 1992) pp. 48, 79-91.

the metallurgical status of the RPV during its review of the plant's license renewal efforts.

In late 1992, a group of five utilities operating seven plants designed by Babcock and Wilcox (the Babcock and Wilcox Owners' Group, BWO), announced its intentions to pursue a joint effort in developing a license renewal application. Because there are several utilities and power plants represented by the BWO, costs and experiences of preparing the license renewal applications can be shared, improving the prospects for a successful application. However, the group does not expect to select a plant and submit an application until 1997. Other owners' groups are developing similar programs.

In December 1992, a senior NRC staff management group undertook a review of license renewal issues at the request of the Commission and proposed a revised implementation approach. The staff review concluded that the rule does not need to be changed, and that an efficient process can be implemented. Despite the favorable NRC staff review, however, there still appear to be some problems and uncertainties with the rule and questions about its practical implementation, which are discussed below. The NRC is continuing to address these issues including holding a public workshop.<sup>22</sup>

As promulgated in 1991, the license renewal rule and the accompanying statement of considerations (SOC) appear somewhat inconsistent with other NRC aging efforts. The license renewal rule and SOC require renewal applicants to perform a formal, and potentially far more detailed, demonstration that aging issues are addressed than otherwise applies to existing plants as they age. In particular, the rule and SOC require utilities to

perform and file with the NRC for approval an integrated plant assessment (IPA). As described in the SOC, the IPA includes a detailed evaluation of aging degradation for all SSCs directly or indirectly affecting safety. Depending on the level of detail required, this evaluation could be a difficult and costly undertaking. An NRC study estimated the cost to be about \$30 million per plant.<sup>23</sup> In contrast, no other NRC regulations require such a formal, detailed evaluation of aging. The recently proposed staff implementation approach would largely bypass this step. Although perhaps appropriate for assuring adequate safety, that staff interpretation strays from the rule's SOC and could expose renewal applications to court challenges.<sup>24</sup>

The rule further requires that licensees obtain regulatory approval of "effective programs" to address any "age-related degradation unique to license renewal" (ARDUTLR) that could occur. In contrast, the NRC's maintenance rule, while requiring utilities to have effective maintenance programs, does not require formal regulatory filing and approval of the detailed programs. Further, while the license renewal rule requires that an effective program must maintain the plant's CLB, the maintenance rule allows other objectives, for example, based on risk-significance.

Beyond some inconsistency with other NRC aging requirements, there are other potential problems with the license renewal rule and its eventual implementation. For example, the concept of ARDUTLR as used in the license renewal rule is less useful than it first appears. Although apparently intended to limit the scope of detailed aging examinations and effective programs to

<sup>22</sup> U.S. Nuclear Regulatory Commission "Additional Implementation Information for 10 CFR Part 54," "Requirements for Renewal of Operating Licenses for Nuclear Power Plants," "SECY-93-1 13, Apr. 30, 1993; and U.S. Nuclear Regulatory Commission, "Implementation of 10 CFR Part 54, 'Requirements for Renewal of Operating Licenses for Nuclear Power Plants,' SECY-93-049, Mar. 1, 1993; and 58 Federal Register 42987.

<sup>23</sup> U.S. Nuclear Regulatory Commission, *Regulatory Analysis for Final Rule on Nuclear Power Plant License Renewal*, NUREG-1362 (Washington DC: October 1991), table 4.6.

<sup>24</sup> Memorandum from William C. Parler, General Counsel, to the U.S. Nuclear Regulatory Commission "License Renewal and SECY 93-049," Mar. 9, 1993, pp. 4,5.



issues not already explicitly addressed in the original license term, according to the NRC staff, there are few if any SSCs that can be readily shown to have no ARDUTLR as defined in the rule. For example, it is difficult to show that even relatively short-lived SSCs under a regular refurbishment or replacement program have no ARDUTLR according to the NRC staff. Regarding long-lived, or life-of-plant SSCs (e.g., containment structures and RPVs), there is little expectation that new aging mechanisms will occur only beyond the original license term. Instead, the rates of degradation and the safety implications are not precisely known, so aging management involves a continuing effort of maintenance and of evaluating operating experience and research.

### ■ Federal Policy Considerations; Assuring Adequate Aging Safety

The Federal Government's main responsibility in relation to nuclear power plants is assuring adequate protection of the public health and safety—a responsibility charged primarily to the NRC. Current regulatory and industry efforts to address aging are designed to provide a reasonable assurance of adequate safety. However, there are some aging issues in the safety regulatory process with longer term implications that may benefit from early attention. The safety policy options listed in table 1-A would not necessarily provide for a greater level of safety—rather they could more quickly identify and resolve concerns likely to arise as aging issues continue to be addressed in the coming years, reducing regulatory uncertainty and allowing more timely decision making by the NRC and the industry.

The first two policy options listed specifically address aging issues. The latter two may be important not only for aging but for the broader array of safety regulation as well.

#### 1. Accelerate Ongoing Aging-Related Safety Activities.

Early license renewal efforts suggest that the NRC's existing aging-related safety efforts could be accelerated. According to the NRC staff, early license renewal efforts helped focus needed attention on two aging issues that are of generic importance to the industry during the original license terms of existing plants—EQ and fatigue. The NRC staff has suggested treating both topics as Generic Safety Issues (GSIs), resulting in a more detailed regulatory re-examination for plants during their current licensed lives. Early license renewal activities at one lead plant (Yankee Rowe) also brought additional attention to a third topic of importance to a smaller number of plants, RPV embrittlement.

That license renewal activities brought this additional attention should not be surprising, since the rule places greater importance on formally identifying and managing aging degradation than is required for plants not seeking license renewal. However, any dependence on license renewal activities to address aging challenges that occur during original license terms may be a perverse allocation of efforts, since the plants most affected by aging degradation may also be those least likely to seek license renewal. Such a dependence also leaves unclear how and at what point such focus will be brought absent future license renewal applications.

To help ensure that other aging issues, whether generic or plant-specific, are focused on in a timely fashion absent detailed license renewal efforts, the NRC could pursue a variety of efforts. For example, the NRC could accelerate and intensify the review of topics raised by industry and NRC aging research programs for application to regulatory activities. This could go a long way to supplanting dependence on license renewal activities to identify aging issues needing additional attention. For example, none of the three topics raised in the license renewal activities noted above were new to industry or to the NRC, having been identified previously in research

programs. In this review, the NRC could also consider the appropriate level of effort applied to aging in long-lived SSCs versus shorter lived, regularly refurbished or replaced SSCs.

Second, as utilities finalize compliance with the maintenance rule over the next 3 years, the NRC could monitor and report on whether the relatively flexible approach (i.e., without formal filing and regulatory approval of plant-specific maintenance programs, and without an equivalent of the plant-specific integrated plant assessment as originally envisioned for the license renewal rule) adequately identifies and addresses aging degradation. In particular, in reviewing maintenance rule compliance and adequacy, the NRC could assess whether the level of technical detail and analysis of aging issues provided by an IPA (as described in the preamble to the license renewal rule) would provide a substantially greater assurance that aging issues are being identified and addressed in a systematic fashion.

## 2. Simplify the License Renewal Rule.

If ongoing aging management programs are adequate during an original license term, it may be possible to considerably simplify the license renewal rule without affecting safety. The recent NRC staff proposals for implementing the current license renewal rule include several simplifications. However, the staff interpretations allowing for the simplifications are not entirely consistent with the rule's preamble and may thus be subject to considerable regulatory and court challenge. For this reason, the NRC staff has proposed consideration of an additional rulemaking to revise the current rule.

In reopening the license renewal rule, it may be worthwhile for the NRC to consider further simplifications in the rule than those contained in the staff proposal. For example, with adequate, ongoing aging management, it may be appropriate to treat license renewal as a relatively simple administrative procedure. One principal justification for the license renewal rule as promulgated in 1991 is the need to address aging degradation

issues that arise during a plant's license renewal term but not in the current license term. However, the practical distinction between ARDUTLR and aging generally is hazy and artificial for both short-and long-lived SSCs. Even for long-lived SSCs, aging management in a current license term may involve revalidation of previous analyses of aging degradation rates and design margins as more operating experience and research are gained. For this reason, it may be better to view aging management as a more continuous process than established in the license renewal rule.

Even assuming the premise that some aging degradation is best viewed as unique to license renewal, it may still be appropriate to simplify the license renewal rule for greater consistency with other NRC aging requirements. Two revisions suggested in the recent NRC staff proposals are: more explicit approval of the use of the maintenance programs required under the maintenance rule; and redefining ARDUTLR in such a way that it focuses on long-lived SSCs and not on short-lived SSCs that are replaced on a time or performance basis.

One potential concern with simplifying license renewal requirements is that it may allow a severely degraded nuclear plant to continue operating beyond its original license term. However, the risk that a simplified license renewal rule would allow should be minimal if other aging management practices are adequate. The two earliest license expirations are set for 2002 and 2007. Any inadequacies in current and planned aging management practices need to be corrected before current licenses expire, rather than relying on license renewal requirements and the ambiguous concept of ARDUTLR.

One consideration in revising the license renewal rule could be whether the estimated \$30 million cost per applicant of producing a detailed IPA is the most productive use of funds for addressing aging issues. It may be more productive to devote resources to addressing aging issues affecting plants in their current license terms, or even to safety issues not directly related

to aging. For example, both human and containment structure performance in existing plants continues to receive NRC and industry attention, and remain sources of uncertainty in safety assessments.

### 3. Revise Public Participation Provisions

The NRC's regulatory process is largely open, and public participation is allowed. However, by virtue of being a licensing proceeding, the license renewal process for any plant will allow a considerably more extensive public role in examining aging issues than provided during the current license term under existing law. For those doubtful of the adequacy of industry and NRC safety efforts, license renewal will allow an important opportunity to challenge licenses both in the NRC hearing process, and quite possibly through the courts.

To the extent that a greater public role at the time of license renewal would help provide a better assurance of adequate safety with respect to aging, it may be worth examining how that benefit could be gained more generally during a current license term and not linked to a specific regulatory action. In the past, public participation has focused NRC attention on aging safety issues leading to license modifications.<sup>25</sup> Revising some public participation provisions may also help alleviate public concerns about safety.

In particular, under NRC regulations,<sup>26</sup> the public may petition the NRC staff to initiate a

proceeding, but there are no provisions for appealing staff decisions either to the Commission or judicially.<sup>27</sup> One approach that has been suggested is to allow judicial review of public petitions to initiate a proceeding to modify, suspend, or revoke a license.<sup>28</sup> A central issue in considering this approach is whether the likely benefits warrant the additional burdens on the court system, the utilities, and the NRC that allowing such review could bring.

An alternate approach that could potentially avoid the cumbersome and confrontational nature of formal hearings is to consider involving critics of the industry and others earlier and more directly in the regulatory process. Providing for more ongoing public participation may also help reduce the uncertainties arising from challenges in the NRC hearing process and the courts. In the past year, noting a longstanding criticism by citizens' groups and some members of Congress with regard to NRC's public petition process, NRC has undertaken an effort, including holding a public workshop, to examine possible revisions to its procedures for treating public petitions.<sup>29</sup> The NRC's enhanced participatory process for establishing site release criteria for decommissioning is one example of a current effort that may be worth expanding to other regulatory areas. Among the approaches that others have suggested include drawing from a broader cross-section of interested and technically competent parties for NRC advisory positions (e.g., the Advisory Com-

---

<sup>25</sup> See, e.g., Union of Concerned Scientists and the New England Coalition on Nuclear Pollution "Petition for Emergency Enforcement Action and Request for Public Hearing," before the U.S. Nuclear Regulatory Commission, June 4, 1991. The aging degradation issue raised in the petition (the effect of embrittlement on the integrity of one plant's RPV) had been previously identified by the NRC staff and was under continued investigation. However, the Chairman of the NRC noted that the petition stimulated the Commission's thorough review of the analyses leading to an NRC order. U.S. Nuclear Regulatory Commission, "In the Matter of Yankee Atomic Electric Company," Memorandum and Order, 50.029, July 31, 1991; and Statement of Ivan Selin, Chairman, U.S. NRC, before the House Subcommittee on Energy and the Environment of the Committee on Interior and Insular Affairs, Aug. 1, 1991.

<sup>26</sup> 10 CFR 2.206

<sup>27</sup> However, the Commission has in the past invoked, at its discretion, the power to review staff decisions upon receiving a petition from a public interest group. U.S. Nuclear Regulatory Commission, "In the Matter of Yankee Atomic Electric Company," Memorandum and Order, 50.029, July 31, 1991.

<sup>28</sup> Examples of legislative proposals to ease these restrictions are found in S. 1165, 103d Congress; and U.S. House of Representatives Rept. 102-474 Part 8, Report on the Comprehensive National Energy Policy Act, Title I Subtitle C, May 5, 1992.

<sup>29</sup> See *Federal Register* 34726 (June 29, 1993).

mittee on Reactor Safeguards), and some form of intervenor funding could be used (e.g., to retain industry critics to review and comment on specific aging-related topics).<sup>30</sup> Some in the industry may object strongly to any requirements to fund critics, either directly or through their NRC fees. However, similar options are used to some degree in various regulatory activities of different States. For example, integrated resource planning efforts performed by States and utilities have increasingly involved participation by the public, consumers, and competing generators in part to lessen the contentiousness of adversarial proceedings. As an example of a broadly based advisory group, the Pennsylvania State Low-Level Waste Advisory Commission specifically includes a wide range of members, including local government, environmental, health, engineering, business, academic, and public interest groups.<sup>31</sup>

#### 4. Apply the NRC's Safety Goal Policy to Aging Issues.

While the NRC's aging-related regulatory activities are elaborate, the relationship between those activities and the NRC's safety goals (box 1-D) could be made more clear. For example, the safety goal policy is not mentioned in the license renewal rule, the 32-page Statement of Considerations accompanying the rule,<sup>32</sup> or the NRC's regulatory analysis of the rule.<sup>33</sup> Similarly, the NRC's most recent plan for its Nuclear Plant Aging Research (NPAR) program does not reference the safety goal policy statement in its approximately 170 pages.<sup>34</sup> The NRC has had an

ongoing effort to make greater application of the safety goal policy.<sup>35</sup> As part of that effort, the NRC could undertake a more visible and comprehensive effort to ensure that its safety goal policy is appropriately translated into regulatory and research activities related to aging. Further, although a good step forward when it was produced in 1986, the policy itself has some limitations and has not been revised despite considerable advances in the state of the art of risk assessment. Several of the limitations relate to plant aging issues. The NRC could revisit its safety goal policy to ensure that it provides as meaningful a basis as possible for NRC regulatory actions for existing plants.

### ECONOMY OF EXISTING PLANTS

The economic prospects for existing nuclear power plants depend not only on the reliability and costs of individual plants but also on the broader economic context of the electric power industry. Uncertainty and change are hallmarks of the electric power industry. Several electric industry trends diminish the long-term economic prospects for existing nuclear plants including: rapid growth in utility industry restructuring and supply competition; low load growth, often resulting in excess capacity; growing utility efforts to tap into a large, low-cost potential for improved energy efficiency; and continuing high availability and low prices for natural gas for electricity generation. At least one trend, incorporating environmental externalities, may improve the prospects, however. In particular, concern over

<sup>30</sup> See, for example, U.S. Congress, Office of Technology Assessment, *Nuclear Power in an Age of Uncertainty*, OTA-E-216 (Washington DC: U.S. Government Printing Office, February 1984), p. 260; and John Kemeny et al., *Report of the President's Commission on the Accident at Three Mile Island* (Washington DC, 1979).

<sup>31</sup> *Laws of Pennsylvania, Act 1988-2*, "An Act providing for low-level radioactive waste disposal," Section 317.

<sup>32</sup> 56 *Federal Register* 64943-64980 (Dec. 13, 1991).

<sup>33</sup> U.S. Nuclear Regulatory Commission, *Regulatory Analysis for Final Rule on Nuclear Power Plant License Renewal*, NUREG-1362 (Washington DC: October 1991).

<sup>34</sup> U.S. Nuclear Regulatory Commission *Nuclear Plant Aging Research (NPAR) Program Plan*, NUREG-1144 Rev. 2, (Washington, DC: June 1991).

<sup>35</sup> U.S. Nuclear Regulatory Commission, "Interim Guidance on Staff Implementation of the Commission's Safety Goal Policy," SECY-91-270.

global climate change and other environmental challenges related to fossil fuel combustion, if factored into economic analyses, could improve the relative economics of existing nuclear plants considerably (box 1-E). Increasingly, these factors are being examined through what are often elaborate planning exercises, called integrated resource planning (IRP).<sup>36</sup>

In addition to change, there is great diversity in electricity market conditions and the value of nuclear power across the country. For example, because excess capacity and fuel costs vary by region, current estimated replacement costs for power are far lower in some areas than in others. Similarly, existing units provided 22 percent of U.S. electricity in 1991, but some regions of the country, primarily along the Atlantic seaboard and parts of the Midwest, are far more dependent on nuclear power (figure 1-1).

All power plants, nuclear and non-nuclear, will eventually be retired. But at what point does it make sense to retire a plant, and what unique issues are raised by nuclear plants? Aging effects on plant economic performance can be important factors affecting the economic attractiveness of existing plants.<sup>37</sup> However, other factors can play an equal or greater role in determining a plant's economic performance, such as the cost and

availability of waste disposal<sup>38</sup> (box 1-F) and the cost of addressing safety issues not related to aging. Decommissioning costs can also be a factor in plant life decisions. For example, one effect of delaying plant retirement is to defer decommissioning, which may be an economic benefit or a burden depending on future cost escalation. Also, delaying plant retirement can allow spreading decommissioning costs over a greater sales volume.

Opinions of the long-term economic prospects for existing nuclear power plants vary greatly. DOE-sponsored studies have estimated that the economic gain from extending operation an additional 20 years could be about \$350 billion nationally.<sup>39</sup> Those results are disputed by some who find that nuclear power costs are high and expect they will continue to grow.<sup>40</sup> Some analysts suggest that as many as 25 plants, not necessarily older ones, may be found uneconomic during the next several years.<sup>41</sup> Certainly, the growing number of recent early retirements, and others currently being investigated, is an indication that prospects are not as economically attractive as thought even as recently as 1992 when an update to the 1991 the National Energy Strategy was published.<sup>42</sup> Still, costs and other economic conditions vary widely among nuclear

---

<sup>36</sup> See U.S. Congress, Office of Technology Assessment, *Energy Efficiency: Challenges and Opportunities for Electric Utilities*, to be published.

<sup>37</sup> As used here, plant economic performance is a combination of the operational costs of a plant, the costs of major refurbishment and other capital additions, and the reliability and output of the plant.

<sup>38</sup> Disposal of both spent fuel and low-level waste (LLW) can present economic challenges. However, LLW volumes during plant operation are small, and current disposal costs represent a fraction of one percent of the operational costs of current nuclear plants. Even with the much higher disposal costs anticipated under the interstate compacts, LLW costs will average only about 1 percent of operational costs. The large volumes of LLW resulting from decommissioning, however, present much greater costs relative to that activity, and are discussed below in that context.

<sup>39</sup> L. Makovich, L. Forest, and T. Fletcher, "U.S. National and Regional Impacts of Nuclear Plant Life Extension," Sandia National Laboratories, SAND87-7136, January 1988.

<sup>40</sup> See, e.g., James G. Hewlett, "The Operating Costs and Longevity of Nuclear Power Plants," *Energy Policy*, July 1992, pp. 608-622.

<sup>41</sup> P.C. Parshley, D.F. Grosser, and D.A. Roulett, Shearson Lehman Brothers, "Should Investors Be Concerned About Rising Nuclear Plant Decommissioning Costs?," *Electric Utilities Commentary*, vol. 3, No. 1, Jan. 6, 1993, p. 1.

<sup>42</sup> The discussion of existing nuclear power plants in the National Energy Strategy reports did not acknowledge the prospect of early retirements. Rather, it emphasized the prospects for license renewal for about two-thirds of existing units. U.S. Department of Energy, *National Energy Strategy: Powerful Ideas for America One Year Later* (Washington, DC: February 1992), pp. 32-36; and U.S. Department of Energy, *National Energy Strategy* (Washington DC: February 1991), pp. 108-116.

### Box 1-E—Existing Nuclear Power Plants and Global Climate Change

The potential for global climate change, a growing environmental concern, clouds the long-term prospect for the continued, heavy international reliance on fossil fuels. The public health and environmental harm that some suggest are likely results of climate change maybe far more severe than even pessimistic assumptions of nuclear accidents. While the operation of existing nuclear power plants does not solve the CO<sub>2</sub> problem (a key greenhouse gas), existing nuclear units help act as a bridge to other nonfossil options including greatly improved energy efficiency, advanced nuclear generation, and renewable supplies. For example, if the 613 billion kWh of electricity produced using nuclear power in 1991<sup>1</sup> had instead been fueled by coal, U.S. CO<sub>2</sub> emissions would have been higher by about 160 million metric tons, over 10 percent of energy sector emissions that year.<sup>2</sup> Similarly, if fueled by natural gas in highly efficient combined cycle units, emissions would have been higher by about 70 million metric tons.

Federal and State environmental policy addressing global climate change could greatly improve the relative economic attractiveness of existing nuclear power plants.<sup>3</sup> An increasing number of States are considering environmental and other externalities in new least-cost planning or integrated resource planning efforts.<sup>4</sup> In April, the President announced a commitment to stabilize greenhouse gas emissions at 1990 levels by the year 2000. What future efforts will be taken to meet that objective is yet to be determined.

Although there are no plans to institute a tax on carbon emissions, the potential impact on relative economics are illustrative. For example, consider a hypothetical \$100 per ton carbon tax, which one Congressional Budget Office study estimated could potentially reduce U.S. CO<sub>2</sub> emissions by between zero and 25 percent from then current levels over a 10-year period. Such a large tax would translate into nearly \$0.03/kWh for coal-fired electric generation, *more* than the average operational costs at existing nuclear power plants.

The environmental drawbacks of nuclear power are also widely noted. Safely storing, transporting, and disposing nuclear wastes present environmental challenges. So too does the potential for a catastrophic nuclear power plant accident, even though the probability of such an accident is very low. Overall, further examination of the relative environmental impacts of producing electricity by fossil, nuclear, renewable, and other sources may help ensure better informed and more timely decisions about the national energy mix and about individual plant lives.

<sup>1</sup> U.S. Department of Energy, Energy Information Administration, *Electric Power Annual 1991*, DOaEIA-0346(91) (Washington, DC: February 1993), p. 32.

<sup>2</sup> Average coal plant carbon emissions are about 0.56 to 0.59 pounds per kWh. Natural gas generation using combined cycle plants produces about 0.26 pounds per kWh. U.S. Congress, Office of Technology Assessment, *Changing by Degrees: Steps to Reduce Greenhouse Gases*, OTA-O-482 (Washington, DC: U.S. Government Printing Office, February 1991), p. 93

<sup>3</sup> Other resources, such as renewable energy and energy efficiency measures, do not produce CO<sub>2</sub> emissions and would also have improved economics. Natural gas and petroleum-fired generation produce about half the CO<sub>2</sub> per unit of electricity as does coal and could be affected as well. However, the dominant role of coal, which supplies 55 percent of the Nation's electricity makes it likely that aggressive action to control CO<sub>2</sub> emissions would affect all aspects of the electricity market.

<sup>4</sup> See U.S. Congress, Office of Technology Assessment, *Energy Efficiency: Challenges and Opportunities for Electric Utilities*, to be published.

<sup>5</sup> U.S. Congress, Congressional Budget Office, *Carbon Charges as a Response to Global Warming: The Effects of Taxing Fossil Fuels* (Washington, DC: U.S. Government Printing Office, August 1990).

### Box 1-F--Spent Fuel Disposal

The **Nuclear Waste Policy Act (NWPA)** requires the DOE to begin accepting spent nuclear fuel from commercial power reactors no later than January 31, 1998.<sup>1</sup> DOE's effort to characterize and potentially construct a permanent spent fuel repository at Yucca Mountain, Nevada will be completed no sooner than 2010, under a schedule viewed by many as optimistic.<sup>2</sup> The DOE has also pursued the development of a monitored retrievable storage (MRS) facility for the interim storage of spent fuel and other high-level waste by the year 1998 to meet NWPA requirements.<sup>3</sup> Serious doubts about whether the DOE could meet the 1998 MRS deadline<sup>4</sup> were substantiated by a December 1992 announcement that the DOE seeks to redirect its existing program substantially by focusing on the development of Federal sites for interim storage.<sup>5</sup>

To cover the cost of disposal, utilities pay the DOE Nuclear Waste Fund (NWF) 0.1 cents for each kilowatt-hour of electricity generated in nuclear power plants, an average of about \$5 million annually per plant. Of the \$8 billion in utility fees and interest collected between 1983 and 1991, \$3 billion has been spent<sup>6</sup> with what many have characterized as little progress. Whether the current fees are adequate, insufficient, or excessive to cover actual disposal costs remains to be seen.

Limited on-site spent fuel storage capacity together with the lack of progress in **DOE's programs undermines public confidence in a resolution to the issue, and could threaten several operating plants with premature closure** in the next fifteen years. For example, Minnesota's Northern States Power (NSP) operates the twin Prairie Island plants having operating licenses expiring in 2011 and 2013, although current spent fuel storage capacity is sufficient only through 1995. To address the shortfall, NSP proposed the installation of a dry storage facility. Out of concern that the dry storage facility would become a de facto permanent repository, however, the Minnesota Public Utilities Commission allowed NSP to construct a smaller facility that would add only seven more years of storage capacity.<sup>7</sup> Further, the facility must be approved by the State Legislature. If unable to operate at the end of that time, this will represent a very large indirect cost of waste disposal.

Several utilities have dry storage facilities in operation or under construction. For example, the Public Service Co. of Colorado (PSC), operator of the retired Fort St. Vrain plant, has constructed a dry storage facility for \$23 million and estimates annual operational costs of about \$1.5 million.<sup>8</sup> The direct costs to utilities and their customers are not large relative to total plant operational costs, but represent an unanticipated burden on utilities and consumers that have paid for and expect a federally run geologic repository.

<sup>1</sup>P.L. 97-425, 96 Stat. 2258, Sec. 302(a) (5)(B).

<sup>2</sup>Nuclear Waste Technical Review Board, *NWTRB Special Report* (Arlington, VA: March 1993), p. v.

<sup>3</sup>U.S. Department of Energy, Office of Civilian Radioactive Waste Management, *Report to Congress on Reassessment of the Civilian Radioactive Waste Management Program, DOE/RW-0247* (Washington, DC: November 1989), pp. ix-x.

<sup>4</sup>See U.S. Congress, General Accounting Office, *Operation of Monitored Retrievable Storage Facility Is Unlike/ by 1998*, GAO/RCED-91-194 (Gaithersburg, MD: September 1991).

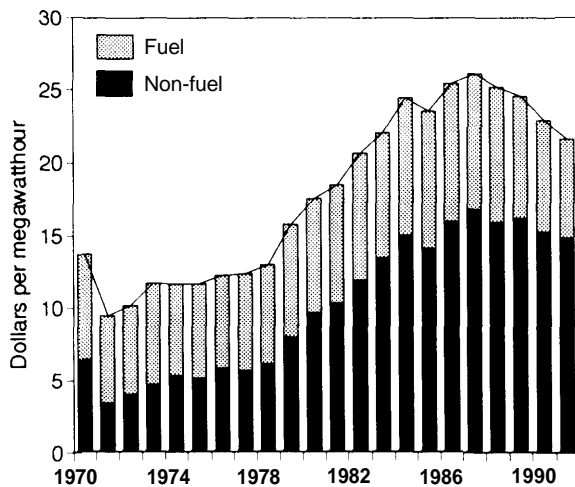
<sup>5</sup>James D. Watkins, Secretary, U.S. Department of Energy, letter to J. Bennett Johnston, Chairman, Senate Committee on Energy and Natural Resources, Dec. 17, 1992, See attachment, p. 2.

<sup>6</sup>U.S. Department of Energy, *Annual Report to Congress: Office of Civilian Radioactive Waste Management, DOE/RW-0335P* (Washington, DC: March 1992), pp. 54,65.

<sup>7</sup>"NSP Gets Reprieve From Minnesota PSC," *The Energy Daily*, vol. 20, No. 124, June 29, 1992, p. 1. <sup>666</sup> also 57 *Federal Register* 34319 (Aug. 4, 1992).

<sup>8</sup>Michael Niehoff, Public Service Co. of Colorado, personal communication, S@. 23, 1992.

**Figure 1-3—Nuclear Power Plant Production Costs 1970-1991 (\$1991)**



SOURCE: Office of Technology Assessment, adapted from Nuclear Engineering *International*, September 1992, p. 45; nominal dollars adjusted using Consumer Prices Index.

plants appear attractive for the foreseeable future, assuming costs are controlled.

Variability in the effectiveness of nuclear utility management has long been recognized.<sup>43</sup> Continuing evidence of variability can be seen in the wide range of plant economic performance and in the NRC's systematic assessment of licensee performance (SALP) program. The wide range of performance indicates there are opportunities for improved economics at many plants. Efforts to control rising operating and maintenance (O&M) costs include individual utility programs and industry-wide initiatives to address O&M costs by all nuclear utilities. The growing awareness of the potential for early plant retirement and other economic performance incentives

may play an important role in motivating utilities to take a variety of steps to reduce cost and improve performance.

### ■ Aging Issues in Plant Life Economics

Real nonfuel (O&M) and fuel costs per unit of electricity generated at nuclear power plants are about triple their 1975 levels (figure 1-3). By 1989, average operational expenditures at U.S. nuclear power plants were higher than for an average coal plant for the first time.<sup>44</sup> Dramatic cost increases in the late 1970s and early 1980s, however, were followed by declines in the late 1980s and early 1990s.<sup>45</sup> While economic retirement decisions are based entirely on plant-specific factors rather than industry averages, the general cost trends do indicate the nature of the economic challenge for the industry. If operating cost trends resume their long-term rate of increase, the operation of many existing nuclear power plants will become less economically attractive, possibly favoring early retirement even where replacement capacity is needed.

Much of the historic growth in operating costs was unrelated to plant aging. For example, the experiences gained from the Browns Ferry accident in 1974 and the Three Mile Island accident in 1979 led to costs for revising both equipment and procedures. The rapid growth in average plant staffing, a primary component of O&M costs, does not appear to be age-related. The future rate of cost escalation is speculative. Some future O&M costs related to aging management could be substantial. For example, the NRC estimated the industry's cost of implementing the maintenance rule at over \$1 billion (1990 dollars).<sup>46</sup> The NRC further estimated that improved operational per-

<sup>43</sup> See U.S. Congress, Office of Technology Assessment, *Nuclear Power in an Age of Uncertainty*, OTA-E-216 (Washington, DC: U.S. Government Printing Office, February 1984), pp. 113-138.

<sup>44</sup> U.S. Department of Energy, Energy Information Administration, *Electric Plant Cost and Power Production Expenses 1989* DOE/EIA-0455(89), (Washington, DC: March 1991).

<sup>45</sup> U.S. Department of Energy, Energy Information Administration (EIA), *An Analysis of Nuclear Power Plant Operating Costs: A 1991 Update*, DOE/EIA-0547, (Washington, DC: May 28, 1991); and U.S. Department of Energy, EIA, *Electric Plant Cost and Power Production Expenses 1990*, DOE/EIA-0455(90) (Washington, DC: June 1992),

<sup>46</sup> 56 *Federal Register* 31306 et seq., (July 10, 1991).

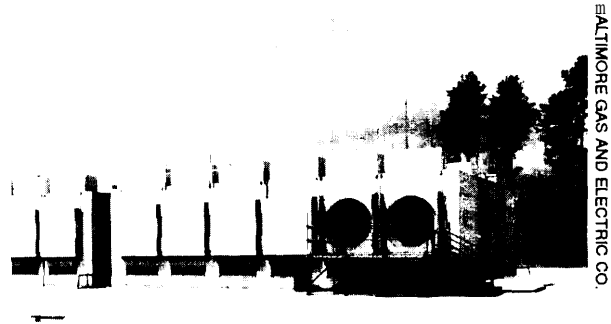


formance and availability would result in a saving of just under \$1 billion. The NRC's cost estimates were disputed by the industry, which asserted that although the costs of regulatory compliance were substantial, current maintenance practices were already appropriate.

In addition to normal operational expenses, many nuclear power plants have required substantial expenditures on capital additions for major plant refurbishment. Although average capital additions costs have declined from their peak in the mid-1980s,<sup>47</sup> many plants will continue to need them. The types of capital additions undertaken at nuclear power plants are varied. Historically, some have been for NRC-required safety backfits unrelated to aging such as fire and seismic protection. However, many plants face major capital additions costs related to aging degradation. Steam generator replacements, performed at several plants already and under consideration for many more, are a major example, costing \$100 to \$200 hundred million dollars per plant. It should be noted that some capital additions such as steam generator replacement, while costly, should also improve plant performance. Depending on how the NRC resolves some issues in the coming years, addressing aging-degradation such as EQ, fatigue, and RPV embrittlement may also involve major capital additions for at least some plants.

The high costs and potential for extended outages may effectively turn some major capital additions decisions into plant life decisions. For example, the prospect of large capital additions requirements at two nuclear power plants (Trojan and San Onofre) prompted economic analyses that eventually led to early retirement decisions. Several other plants facing steam generator replacements are also performing detailed economic analyses.

Because capital additions costs may be amortized over the life of a plant, license renewal can



*The independent spent fuel storage installation (ISFSI) for Baltimore Gas and Electric Company's Calvert Cliffs plants is one of several in operation or under development. With delays anticipated in the Federal Government's opening of high-level waste facilities, continued operation of many commercial nuclear power plants may require development of ISFSIs.*

affect plant life decisions even before license expiration. For example, if a utility considers license renewal, replacing a faulty steam generator (leading to a remaining life of 40 years or more) may be more attractive economically than shorter lived but less costly repairs such as plugging or sleeving the steam generator tubes or, as in the case of the Trojan plant, early retirement based on the life of the current steam generators. The importance of license renewal in economic life decisions will grow as plants near the end of their licenses. But again, only two plants, including one very small one, will require license renewal for continued operation in the next 15 years.

## ■ Institutional Roles in Deciding Economic Plant Lives

Responsibility for the economic performance of existing nuclear power plants lies with the utilities operating them. However, the responsibility for economic decisions regarding nuclear power plant lives, while lying primarily with the

<sup>47</sup> U.S. Department of Energy, Energy Information Administration, *An Analysis of Nuclear Power Plant Operating Costs: A1991 Update*, DOE/EIA-0547, (Washington, DC: May 28, 1991). Capital additions costs (for major retrofits and repairs) have been highly variable.

owning utilities, is generally also a function of the respective State regulators.<sup>48</sup> In addition to regulating retail electric prices, many States also regulate other aspects of utility operations in some detail including IRP decisions related to new capital investment and plant retirement. The direct and indirect economic incentives established by State regulators and the Federal Energy Regulatory Commission (FERC) can also play important roles in plant life decisions. Members of the public, including electricity consumers and other interest groups, often intervene and otherwise participate in economic regulatory processes.

The objectives in nuclear plant life decisions derive from the broader electric power system objectives, including: assuring adequate supplies to meet demand; minimizing the costs of electricity (including, increasingly, environmental costs); equitably treating both electricity consumers and plant owners in the recovery of costs; and, increasingly, responding to intensifying market forces in the electric power industry. Utilities and State regulatory bodies are increasingly developing elaborate regulatory and planning processes for evaluating electricity supplies to meet these objectives.

As is typical in the electric utility industry, there are major uncertainties in the factors determining economic plant lives. For example, in its decision endorsing retirement of Unit One of the San Onofre plant, the California Public Utilities Commission was unable to determine whether or not the plant would be cost-effective in the

future.<sup>49</sup> Rather, it found that ‘there is substantial evidence on both sides of the cost-effectiveness issue’ and that the available analysis may not provide a good indication of future performance.<sup>50</sup> Rather than representing a clearly optimal choice, that and other retirement decisions involved professional judgment and a balancing of the alternative choices and their uncertain outcomes. Because many factors in economic analyses are inherently subjective, some have suggested that certain past State regulatory activities leading to plant retirement reflected an antinuclear bias rather than solid economic analysis.<sup>51</sup> However, while there is certainly potential for bias in any planning process involving the complex and uncertain factors found in the utility industry, past retirement decisions do not provide compelling evidence of regulatory manipulation.

The prospect of early power plant retirement introduces some novel issues.<sup>52</sup> In particular, there is limited precedent in the economic regulation of the electric industry to guide the financial treatment of capital invested, but not yet recovered in rates, following early plant retirement. Similarly, there is little precedent for the treatment of shortfalls in decommissioning funds resulting from early retirement. Of the six recent early retirement decisions, unrecovered capital and decommissioning costs ranged from a few hundred million dollars for most to over \$4 billion for one.<sup>53</sup> Consumers bore most or all of the costs in three cases; in one case the utility bore the unrecovered capital costs, and consumers bore decommissioning costs; in the case of a public

---

413 Most nuclear plants are operated by investor-owned utilities and fall under economic regulation by the Federal Energy Regulatory Commission or State regulators. Five plants are publicly owned (e.g., by a public power authority). Three other operating plants are owned by the Tennessee Valley Authority (TVA). TVA also has two previously operating units with full power licenses under review (Browns Ferry 1 and 3).

<sup>49</sup> In contrast to the Commission’s uncertainty about the plant’s economics, the California Public Utilities Commission Division of Ratepayer Advocates argued that the plant was demonstrably not cost effective.

<sup>50</sup> California Public Utilities Commission, *Opinion on SONGS 1 Settlement Agreement*, Decision 92-0S4)36, Aug. 11, 1992.

<sup>51</sup> See, e.g., Phillip Bayne, ‘Nuclear Power in 1992: A Year-End Review,’ remarks to *The Energy Daily’s Annual Utility Conference*, Dec. 10, 1992.

<sup>52</sup> These issues would be relevant to any early plant retirement, not just for nuclear units.

<sup>53</sup> The extreme exception is the Shoreham plant, which was retired before commercial operation began.

power district, the owners and the consumers were the same; and as of summer 1993, cost recovery for one plant had not been decided.

Allowing a utility to recover its capital costs in an early retirement is consistent with the traditional regulatory approach in many States where the prudence of the plant investment is determined when the plant becomes operational (e.g., the plant is found to be “used and useful.”) Further, not allowing a utility to recover its investment in a plant retired early can create an incentive to keep uneconomic plant in operation. However, the concept of allowing capital recovery in early retirement is not without critics. For example, some in the industry have suggested that allowing favorable terms for capital recovery has been used as an incentive for plant retirement by State regulators biased against nuclear power.<sup>54</sup> Finally, in those retirement cases in which plant performance was poorer and costs were substantially higher than originally anticipated, there may remain a question of whether the utility performed adequately during the operating life of the plant and whether some cost disallowances are warranted.

### ■ Federal Policy Considerations: Supporting Economic Decisions

Although the Federal Government plays a major role in guiding and supporting State economic regulatory activities for electric utilities,<sup>55</sup> Federal interests and influence over economic life decisions for nuclear plants are largely indirect. However, Federal policies for safety regulation, spent fuel disposal, environmental protection, and research can have substantial impacts on the long-term economy of existing

plants. The Federal policies listed in table 1-A could help address several uncertainties related to the economy of plant lives, helping States and nuclear utilities make more timely and better informed decisions.

#### 1. Address Aging-Related Regulatory Safety Issues.

Resolving aging-related regulatory safety issues could greatly reduce uncertainty about the long-term economic attractiveness of existing plants. Each of the policies discussed earlier regarding safety regulation can have substantial impacts on economic attractiveness. For example, accelerating regulatory re-examination of aging issues such as EQ and fatigue as they arise would help clarify long-term capital additions requirements. Clarifying license renewal requirements and demonstrating a workable process will similarly enable utilities and their economic regulators to determine better prospective plant lives, and assess the economics of capital additions.

#### 2. Address Federal Obligations for Nuclear Waste.

DOE’s lack of progress in developing both a monitored retrievable storage (MRS) facility and the ultimate repository for spent nuclear fuel have been notable challenges to the economy of existing plants. Many opportunities for, and challenges to, speeding the development of an MRS and the repository have been discussed elsewhere, and are not the topic of this report.<sup>56</sup> Notably, a recent DOE proposal suggested developing specialized casks for storage, transport, and ultimately, disposal; and accepting commercial spent fuel for interim storage at Federal sites.<sup>57</sup> More recently, the Secretary of Energy has suggested that the DOE should assume financial

<sup>54</sup> P. Bayne, “Nuclear Power in 1992: A Year-End Review,” Remarks to *The Energy Daily’s Annual Utility Conference*, Dec. 10, 1992.

<sup>55</sup> See, for example, the Federal Power Act (1935), 16 U.S.C. 791a; the Public Utility Regulatory Policies Act of 1978 (P.L. 95-617 PURPA); and the Energy Policy Act of 1992 (P.L. 102-486; EPACK).

<sup>56</sup> See, e.g., U.S. Congress, Office of Technology Assessment *Managing the Nation’s Commercial High Level Radioactive Waste*, OTA-O-171 (Washington, DC: U.S. Government Printing Office, March 1985); and the National Research Council, 1991.

<sup>57</sup> James D. Watkins, Secretary, U.S. Department of Energy, letter to J. Bennett Johnston, Chairman, Senate Committee on Energy and Natural Resources, Dec. 17, 1992. See attachment, p. 2.

U.S. NUCLEAR REGULATORY COMMISSION



*The Davis-Besse Nuclear Power Station, operated by Toledo Edison Company, is one of seven operating U.S. nuclear power plants designed by Babcock and Wilcox (B&W). The members of the B&W Owners' Group are working jointly to prepare a license renewal application for one of the B&W plants, to be selected later.*

responsibility for spent fuel in 1998 if a final repository is not yet available.<sup>58</sup> Given the importance of spent fuel disposal to continued plant operation, the Federal Government could consider additional options to clarify and fulfill the Federal obligations for disposing spent nuclear fuel, helping utilities and States develop appropriate plans for addressing their spent fuel storage needs and costs.

First, the Federal Government could specify its obligations if the 1998 Nuclear Waste Policy Act (NWPA) deadline to open a high-level waste disposal site is missed. The DOE could be required to take title to the fuel and/or reimburse utilities for the cost of constructing additional storage facilities. Alternatively, the DOE could modify its contractual agreements with utilities by specifying the exact date the agency would assume title to spent commercial fuel. The cost to

the Federal Government to reimburse utilities for interim spent fuel storage could be on the order of \$20 million to \$35 million in today's dollars per dry storage facility, plus operating costs. More than enough, however, has been collected already from utilities to cover the construction of sufficient dry storage at all their sites. At present, the DOE lacks the express authority to reimburse utilities, but this option could be an equitable way to compensate licensees forced to manage waste that they have been paying the Federal Government to dispose of beginning in 1998.

Second, it may be worth considering decoupling MRS construction from the licensing of a geologic repository. Under NWPA as amended, the construction of an MRS is prohibited until a geologic repository is licensed, and only two are allowed.<sup>59</sup> However, delays in repository characterization threaten the viability of the interim MRS disposal option, because they impose an automatic delay on MRS construction. In considering decoupling, it should be noted that the growing number of dry storage facilities owned and operated by utilities already represents the creation of multiple MRS facilities, though each on a smaller scale.

### 3. Expand Analyses of Nuclear Plant Economics.

The Federal Government has long been a principal source of information on plant costs and performance, and how those relate to the broader electric industry context. Utilities and States are increasingly devoting considerable resources to such economic analyses, and in most cases they are ultimately responsible for economic decisions. However, the large amount of resources at stake in plant life decisions suggests that Federal policymakers have a need for independent assessments of relative costs and performance. There are several areas for improved information collec-

<sup>58</sup> O'Leary Speaks of DOE "Obligation" to Assume Financial Responsibility in '98," *Electric Power Alert*, vol. 3, No. 12, June 9, 1993, pp. 13-14.

<sup>59</sup> Nuclear Waste Policy Act (NWPA) P.L. 100-203, 101 Stat. 1330-236, sec. 5021.

tion and analyses. Progress in these areas would provide better information for plant life decisions:

- Improve nuclear plant cost data collected by the Federal Government. As reported by utilities, plant-specific operational costs have been estimated to understate actual costs for nuclear plants by about 30 percent due to definitional problems.<sup>60</sup> Costs such as insurance and NRC fees, for example, are not reported as plant costs, but as utility-wide overhead.
- Identify root causes of historical operational and capital cost increases as a basis for future projections. For example, one Energy Information Administration analysis of nuclear plant operational costs identified research efforts such as detailed regulatory case studies that could help differentiate the effects of changing NRC regulatory requirements from the effects of new technology and information. Similarly, research could be performed to help distinguish between, and project the effects of, plant **aging** (which should increase costs), and utility experience (which could either increase or decrease costs).
- Identify the causes for the wide variation in costs and performance among the 107 existing nuclear plants. For example, although some of the wide variation in plant staff levels (**a large** component of operational costs) is due to different plant size and age, much of the reason is unexplained.
- Improve estimates of decommissioning costs and cost escalation rates (see below).
- Continue research into broader electricity market conditions and the application of IRP, particularly considering the implications for

existing nuclear plants. Existing avenues for this work are DOE's IRP Program, which was originally established in response to congressional initiatives; and in the development of the DIP that the Energy Policy Act of 1992 requires TVA to perform.<sup>61</sup>

#### 4. Cofund Industry R&D for Existing Plant Issues.

Although the industry is developing many new technologies to improve nuclear plant cost and performance, many promising candidates remain only partially pursued. This is true despite the fact that the electric utility power industry is both large (with revenues of about \$200 billion annually) and mature. In its 1992 Research&Development Plan, the Electric Power Research Institute (EPRI), identified attractive opportunities in nuclear operational cost control and safety improvements totaling nearly \$60 million annually over the plan's 4-year planning horizon. EPRI estimates that only approximately half of that total will be funded.<sup>62</sup> A larger fraction of DOE's R&D effort could be devoted to existing nuclear plant opportunities. For example, a recent National Research Council study recommended a near doubling of such research to \$10 million, even while substantially cutting DOE's overall commercial nuclear R&D budget.<sup>63</sup> The national labs may be well-suited to performing some of this work.

#### AFTER RETIREMENT: DECOMMISSIONING

After a nuclear power plant is retired, NRC regulations require that decommissioning be performed to protect the public and the environment

---

<sup>60</sup> H.I. Bowers, L.C. Fuller, M.L. Myers, *Cost Estimating Relationships for Nuclear Power Plant Operation and Maintenance*, ORIWT'M-10563, November 1987.

<sup>61</sup> P.L. 102-486, Sec. 113.

<sup>62</sup> Electric Power Research Institute, *EPRI Research & Development Plan 1992* (Palo Alto, CA: January 1992).

<sup>63</sup> National Research Council, *Nuclear Power: Technical and Institutional Options for the Future* (Washington, DC: National Academy Press, 1992), pp. 13, 175.

from accidental releases of the remaining radioactivity.<sup>64</sup> Decommissioning involves plant decontamination, reactor dismantlement, waste packaging, and finally, transportation of the waste to a disposal facility. Decommissioning does not necessarily involve removal of all radionuclides from a site. Rather it involves removal of sufficient materials such that the resulting level of potential exposure provides adequate protection of public health and safety as determined by regulatory agencies (see below).

Decommissioning experience worldwide is limited thus far to small reactors (less than 250 MW) that generally had short lives and low residual radioactivity. At present, the largest U.S. reactor decommissioned to date has been the small (72 MW) reactor at Shippingport. Larger commercial reactors that are being retired today or in the future, on the other hand, typically will have operated longer and have far higher levels of residual radioactivity.

Although no large commercial reactors have undergone complete decommissioning yet, decommissioning experience with small reactors, and with maintenance activities for operating plants involving decontamination or removal of large SSCs, suggests that the task of decommissioning large commercial nuclear power plants can be accomplished with existing technologies. Advances in technologies, such as chemical decontamination methods and robotics, are being used to perform decommissioning and to reduce further occupational radiation exposures. Many

of the conventional technologies used to decommission nuclear power plants are the same ones used to demolish other industrial facilities and buildings, including torches, saws, and controlled explosives. On the other hand, current technologies may require improvements if future residual radioactivity standards, under development at the NRC, are significantly more stringent than current criteria.

Waste disposal (including both spent fuel and LLW) presents a major uncertainty in the prospects for performing commercial nuclear power plant decommissioning. A primary activity of decommissioning is to move radionuclides associated with low-level waste (LLW) from a plant site to a LLW facility. Under the Low-Level Radioactive Waste Policy Amendments Act of 1980, as amended (LLRWPA),<sup>65</sup> responsibility for developing LLW facilities rests with the States, which are encouraged to form interstate compacts. In the early 1970s, six LLW disposal sites were available to commercial nuclear power licensees. Three closed in the 1970s<sup>66</sup> and another (Beatty, Nevada) closed in January 1993. The two sites remaining in operation are in South Carolina (Barnwell) and Washington (Richland), both of which are, or soon will be, restricted to members of their respective compacts. No new LLW disposal sites have been licensed, and legal and other challenges have delayed or terminated construction plans for all currently planned sites.<sup>67</sup> In the interim, NRC rules allow, but do not encourage, use of existing plant sites for LLW

---

<sup>64</sup> Complete plant dismantlement and site restoration may intuitively seem like basic elements in “decommissioning” any nuclear or non-nuclear facility, but these tasks are not necessary to address the radiological hazard at a nuclear power plant site. As a result, NRC decommissioning rules do not require the dismantlement of nonradiological portions of nuclear power plants nor site restoration although plant owners may perform this other work.

<sup>65</sup> P.L. 99-240

<sup>66</sup> These three sites were in West Valley, NY (closed 1975); Maxey Flats, KY (closed 1977); and Sheffield, IL (closed 1978). U.S. Department of Energy, Office of Civilian Radioactive Waste Management, *Integrated Data Base for 1991: U.S. Spent Fuel and Radioactive Waste Inventories, Projections, and Characteristics*, DOE/RW-0006, Rev. 7 (Washington DC: October 1991), p. 118.

<sup>67</sup> R.R. Zuercher, “Nebrom Officials Going Back to Beginning to Slow LLW Site Progress,” *Nucleonics Week*, vol. 33, No. 21, May 21, 1992, pp. 8-9; J. Clarke, “Deadlines Loom But No LLW Sites Open Yet,” *The Energy Daily*, vol. 20, No. 204, Oct. 22, 1992, pp. 1-2; U.S. Congress, General Accounting Office, *New York’s Adherence to Site Selection Procedures is Unclear*, GAO/RCED-92-172 (Gaithersburg, MD: August 1992); R.R. Zuercher, “Illinois Back to Square One on LLW Disposal Facility Siting,” *Nucleonics Week*, vol. 33, No. 44, Oct. 29, 1992, pp. 4-5.

storage. Mixed wastes (i.e., chemical hazards that are also LLW) raise special regulatory challenges yet to be fully addressed.

Decommissioning costs will depend on many factors including the approach used (e.g., the length of storage before work begins); the nature and extent of plant radioactivity and other site contamination; local labor rates; waste disposal costs; the number of reactors on a site; and applicable State and Federal occupational and environmental radioactivity standards.

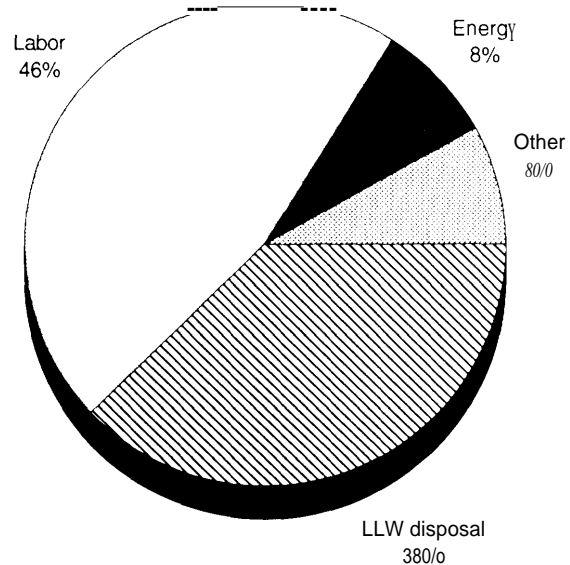
Estimates of decommissioning costs have increased rapidly in the past several years for many plants. Two factors introduce substantial uncertainty in current decommissioning cost estimates: LLW disposal fees and the amount of labor required to perform specific tasks. LLW disposal and labor costs comprise the two largest portions of estimated decommissioning costs (see figure 1-4). LLW disposal costs, currently estimated to comprise about one-third of total decommissioning costs, have been rising several times faster than inflation. The long-term prospects for siting new LLW disposal facilities and their costs remain uncertain.

Also, work difficulty, productivity, and scheduling conditions are difficult to determine reliably in advance of actual decommissioning, suggesting there is no simple and accurate way to determine the reliability of projected labor costs. More experience decommissioning large reactors in the future should reduce uncertainties in labor cost estimation considerably.

### ■ Standards for Timing and Thoroughness of Decommissioning

As defined by NRC rules, decommissioning involves removing a reactor from service and reducing residual radioactivity to a level that allows a site to be released for unrestricted use, thereby allowing license termination.<sup>68</sup> However,

**Figure 1-4-Decommissioning Cost Elements 1,175 MW Pressurized Water Reactor**



SOURCE: G.J. Konzek and R.I. Smith, Battelle Pacific Northwest Laboratory, *Technology, Safety and Costs of Decommissioning a Reference Pressurized Water Reactor Power Station: Technical Support for Decommissioning Matters Related to Preparation of the Final Decommissioning Rule*, NUREG/CR-0130, Addendum 4 (Washington, DC: U.S. Nuclear Regulatory Commission, July 1988, p. 31.

**NRC** rules do not prescribe the conditions making a site suitable for unrestricted use. Rather, the determination of ‘how clean is clean enough?’ is currently made on a site-specific basis using interim NRC guidance criteria first developed almost two decades ago.<sup>69</sup> These criteria **allow** a slightly elevated level of radiation relative to pre-existing background conditions. In 1992, the NRC initiated a process to revise the existing criteria and develop more formal standards for final site radiological release. The NRC expects to promulgate a final rule in 1995.

The negative public and political reaction to the 1990 “below regulatory concern” (BRC) policy may indicate potential problems with the

<sup>68</sup>10 CFR 50.2

<sup>69</sup> U.S. Nuclear Regulatory Commission, Regulatory Guide 1.86 “Termination of Operating Licenses for Nuclear Reactors,” June 1974. Additional guidance was issued in the early 1980s.

current NRC residual radioactivity criteria. Depending on the site, States and the public may have different expectations than the NRC about acceptable levels of residual radioactivity. In many cases, the levels of residual radioactivity implied by current NRC guidance maybe acceptable but, in others, State and public concerns about future land uses at decommissioned sites may overshadow regulatory decisions over the selection of any quantitative standards.

Recognizing that public acceptance will be crucial to the success of the final site release standards, the NRC has taken a novel approach to the rulemaking. Called an “enhanced participatory rulemaking,” the NRC has conducted several public workshops prior to its development of a proposed rule.<sup>70</sup> In its rulemaking, the NRC is considering a range of issues, including the appropriate level and distribution of risk over time between both the decommissioned site and the LLW site; the use of costs and benefits in selecting a risk level; and consistency with other Federal laws protecting health and safety. Public comments provided to the NRC have also raised the question of whether allowing restricted land uses at some sites may be a reasonable alternative to the current goal of unrestricted release.

The effect such standards will have on total decommissioning waste volumes, and thus costs, is difficult to determine. However, unless new site release standards are far more stringent than the current requirements (e.g., requiring a return to background levels), the effect on the technical ability to perform decommissioning should be minimal. More stringent standards could alter the amount of material treated as low-level waste. Because LLW disposal is a major portion of decommissioning costs, more stringent standards could result in greatly increased costs.

NRC rules specify the time period over which decommissioning can be performed. The three general types of decommissioning approaches are: immediate plant dismantlement (known as DECON), initial decontamination followed by a storage period and subsequent dismantlement (SAFSTOR), and enclosing and securing a facility for up to 60 years, followed by eventual release of the site (ENTOMB).<sup>71</sup> The major advantage in waiting to decommission a reactor is to allow short-lived radionuclides, which account for most of the residual radioactivity at nuclear power plants, to decay naturally at the site. As the radioactivity diminishes, potential occupational and environmental radiation exposures are reduced. While the total volume of radioactive waste requiring disposal may be relatively unchanged depending on the storage period, the level of radioactivity would be lower.

Of the decommissioning approaches recognized by the NRC, the ENTOMB option, which involves sealing and securing a site after a minimal amount of decontamination and dismantlement, requires the least remediation over the long term. ENTOMB involves costs for site security and monitoring over an extended period. However, monitoring and security costs may not be great if another plant is operated on the same site, which may be likely in many cases since the transmission facilities and other infrastructure at a site make it well-suited for another generating plant.

The NRC considers 60 years a reasonable period to complete decommissioning. However, engineering studies indicate that the ENTOMB option cannot assure sufficient radioactive decay of long-lived radionuclides in the activated reactor vessel and its internal components to allow

---

<sup>70</sup> 57 *Federal Register* 58727-58730 (Dec. 11, 1992); and U.S. Nuclear Regulatory Commission, “Briefing on Rulemaking Process for Developing Residual Radioactivity Standards for Decommissioning,” Briefing to the Commission (Rockville, MD: Mar. 11, 1992).

<sup>71</sup> 10 *CFR* 50.82@)(l). Under special circumstances, the NRC will extend this period to about 100 years. See 53 *Federal Register* 24023 (June 27, 1988).



site release within that time.<sup>72</sup> Uncertainties about the regulatory viability of the ENTOMB approach have made the option unattractive, even though it could be useful in limiting radiation exposures, waste volumes, and total decommissioning costs.

### ■ Paying for Decommissioning

To assure that adequate financing is available for decommissioning, the NRC requires utilities to set aside funds over the life of a plant. The funds required in NRC's financial assurance provisions are not intended to be cost estimates. Rather, the NRC has stressed that its decommissioning provisions provide a reasonable approximation of the *minimum* costs. Further, the NRC's provisions exclude spent fuel management, even though some storage costs are likely to be incurred until the DOE takes receipt.

Although total decommissioning costs are highly uncertain and are large if viewed as a one-time expense, they are not large relative to total production costs over the entire expected life of a plant. Even at the high end of current estimates, funds set aside for decommissioning are only a few percent of production costs when collected over a few decades of plant operation. However, early retirement or rapidly increasing decommissioning cost estimates toward the end of a plant's life may result in substantial underfunding of decommissioning accounts.

To address funding inadequacy for cases of early retirement, the NRC promulgated a 1992 rule requiring case-by-case determinations of licensee financial conditions.<sup>73</sup> The preamble to the rule stated that the NRC would allow the collection of funds through the original license expiration date, assuming that utility retained an "A" bond rating. For a utility with an early retirement unable to retain an A rating, total

funding within 1 year would be required. However, each of the six recent early retirements required funding assurance mechanisms deviating from the NRC guidance in the new rule. Several lacked the required bond ratings, while others intend to accumulate funds beyond the original license term.

### ■ Federal Policy Considerations for Decommissioning

Absent license renewal, about three dozen operating nuclear power plants will have to retire in the next 20 years. More immediately, the coming decade may bring several early retirements of large plants, which generally are larger and more contaminated than the plants decommissioned to date. Commercial nuclear power plant decommissioning, therefore, is likely to become a much more visible issue in the next two decades. However, final decommissioning of all but a few very special cases will likely not be performed before early in the next century. Rather, most retired plants will go through at least a several-year waiting period allowing short-lived radioisotopes to decay.

There are several options beyond those currently being pursued that may help address existing gaps in decommissioning policies. Of greatest near-term importance are reconsidering the goals for decommissioning and the adequacy of decommissioning financing, and clarifying policies for LLW disposal.

#### 1. Revise Goals for Decommissioning Timing and Site Release.

The NRC's promulgation of final residual radioactivity standards for site-release, scheduled for completion in 1995, will play an important role in filling a major gap in current decommissioning policy. Such standards will determine the

---

<sup>72</sup> R.I. Smith, G.J. Konzek, and W.E. Kennedy, Jr., Battelle Pacific Northwest Laboratory, *Technology, Safety and costs of Decommissioning a Reference Pressurized Water Reactor Power Station*, NUREG/CR-0130 (Washington DC: U.S. Nuclear Regulatory Commission, June 1978), vol. 1, pp. V, 4-5 to 4-6.

<sup>73</sup> 57 *Federal Register* 30383-30387 (July 9, 1992).

ultimate scope and costs of decommissioning work. As part of the rulemaking on site-release standards, alternatives to the single current goal of unrestricted use may be worth developing. In some cases, cleanup to a level suitable for unrestricted use may be neither necessary for public health and safety nor economically desirable, because the expected radiation exposures at a retired power plant site will vary depending on its subsequent use. For example, agricultural activities at released plant sites would introduce different exposure pathways and doses compared to residential use of the same area.<sup>74</sup> Rather than introduce the added occupational risk and economic cost of remediating a site to permit any activity whatsoever (such as farming, for instance), it may be advisable in some cases to remediate to a level allowing restricted use for select activities, such as continued power production, provided that future exposures from those activities will comply with regulatory goals and standards for the **protection** of public and occupational health and the environment.

Nuclear power plant sites are developed industrial facilities, generally **located near** water, transport and electrical infrastructure, and **some may** be well-suited for further power production or other industrial activities, rather than farming or recreational space, for example. Therefore, remediating **a site** to allow future uses unlikely to occur may not be warranted from a health protection or economic perspective. At the same **time**, States and the public may accept or prefer restricted land uses or access at some former nuclear facility sites, based on concerns about health and safety from any residual radioactivity on site. To increase the options to perform site cleanups that protect public health and the environment and that are economically feasible, alternatives to

unrestricted use may be worth considering, such as restricted use for other industrial purposes.

The NRC could also clarify whether ENTOMB is still a viable decommissioning strategy and, if so, under what conditions. During a 1988 rulemaking, the NRC considered eliminating ENTOMB as a decommissioning option but instead decided to develop more specific guidance on its appropriate uses.<sup>75</sup> No such guidance has been forthcoming. In reexamining ENTOMB as an option, the potential safety benefits (e.g., minimal site work; lower occupational exposures; reduced waste volumes; and deferred and reduced need for permanent LLW sites) and the added challenges (e.g., deferring responsibility to future generations; regulating retired plants as temporary LLW sites) need consideration. Such a review could consider variations of ENTOMB, such as removing the highly radioactive reactor vessel and internal components prior to sealing and securing the plant site. In some cases, ENTOMB may be a reasonable option to consider based on both safety and economic reasons, and may be acceptable to the public.

Reconsideration of the ENTOMB option is a natural extension of re-examining the concept of unrestricted site release under certain circumstances. In particular, the extended period of site restriction implied by the ENTOMB option suggests that the option may be appropriate in some cases if restricted use becomes an acceptable regulatory outcome of decommissioning.

## 2. Reconsider Adequacy of Decommissioning Financing.

Early retirements and cost uncertainty both raise questions about the adequacy of current decommissioning funding requirements. Recent site-specific estimates of decommissioning costs are far higher than the NRC's funding requirements.

---

<sup>74</sup> W.E. Kennedy, Jr., D.L. Strege, Pacific Northwest Laboratory, *Residual Radioactive Contamination From Decommissioning: Technical Basis for Translating Contamination Levels to Annual Total Effective Dose Equivalent*, NUREG/CR-5512, vol. 1 (Washington, DC: U.S. Nuclear Regulatory Commission October 1992).

<sup>75</sup> 53 *Federal Register* 24023-24024 (June 27, 1988).

This is true for both plants retired early and those expected to operate for their full licensed lives. The NRC's finding requirements use simple sliding scales that establish the amount of financial assurance for each reactor according to its size. However, size is not the only nor necessarily most important determinant of decommissioning cost. Moreover, utilities are increasingly using site-specific estimates for State and utility economic planning, not the minimum NRC cost figures. This raises the question of whether the usefulness of the NRC figures could be improved by reflecting better the expected—rather than minimum—costs of decommissioning. Although the NRC is performing an update of its original studies, the topic may deserve considerably more attention given the increasing number of plants facing early retirement and decommissioning. Further, the NRC's recent rule addressing financing adequacy for early retirements bears reexamination, particularly in light of the fact that each of the six plants recently retired did not meet the conditions laid out in the rule's preamble.

### 3. Clarify Regulatory Policies for Low-level Waste.

Disposal of LLW, including that mixed with hazardous chemicals, rests with States. However, the Federal Government retains responsibility for setting standards for LLW (including mixed waste) facilities. Until more LLW disposal facilities are available, waste may increasingly have to be stored temporarily at plant sites. This practice is allowed, but discouraged, by NRC rules. Given that temporary storage may be unavoidable in the

near term, it may be worth reexamining safety regulation of onsite storage of LLW, particularly in the case of decommissioning. Two alternatives for handling LLW in lieu of permanent disposal sites are: deferring decontamination, reactor dismantlement, and waste packaging until a LLW site is available; or performing that work, and storing the packaged wastes at the plant until a LLW site is available.

Mixed waste management remains an incompletely resolved regulatory issue. At present, there are three commercial mixed waste disposal sites (Colorado, Florida, and Utah), but their disposal permits are restricted to select waste groups with low activities.<sup>76</sup> In the future, the DOE may coordinate with States in the development of more mixed waste treatment and disposal capacity,<sup>77</sup> but existing disposal capacity appears insufficient to meet all commercial needs. The NRC is responsible for regulating the radioactive portion of mixed waste under the AEA. The U.S. Environmental Protection Agency (EPA) has direct responsibility or oversight of States in regulating the hazardous chemical portion under the Resource Conservation and Recovery Act of 1976, as amended.<sup>78</sup> Congress could clarify the regulatory responsibilities of the NRC and the EPA.<sup>79</sup> Recent industry efforts to limit mixed waste generation—source reduction, recycling, processing, waste segregation—are notable, but such efforts do not eliminate completely the need for final disposal options.<sup>80</sup>

---

<sup>76</sup> J. A. Klein et al., Oak Ridge National Laboratory, *National Profile on Commercially Generated Low-Level Radioactive Mixed Waste*, NUREG/CR-5938 (Washington DC: U.S. Nuclear Regulatory Commission December 1992), pp. 32-35.

<sup>77</sup> U.S. Department of Energy, *Department of Energy Strategy for Development of a National Compliance Plan for DOE Mixed Waste*, predecisional draft (Washington DC: November 1992), pp. 4, 20, 24.

<sup>78</sup> P.L. 94-580, Oct. 21, 1976.

<sup>79</sup> For a detailed examination of these LLW policy issues, see U.S. Congress, Office of Technology Assessment, *Partnerships Under Pressure: Managing Commercial Low-Level Radioactive Waste*, OTA-O-426 (Washington, DC: U.S. Government Printing Office, November 1989).

<sup>80</sup> Rogers and Associates Engineering Corp., *The Management of Mixed Low-Level Radioactive Waste in the Nuclear power Industry*, NUMARC/NESP-006 (Washington, DC: Nuclear Management and Resources Council, Inc., January 1990), pp. 5-1 to 5-22.

**4. Use Early Retirements as Decommissioning Case Studies.**

Finally, current and planned early retirements provide an opportunity to learn more **about the** adequacy of current decommissioning policies and cost analyses. Even for those plants not opting for immediate dismantlement, actual experience may help reduce much of the uncertainty related to labor costs, the largest cost component of decommissioning.

After a nuclear plant is retired and the fuel has been removed from the reactor, the potential public safety risks decrease greatly. For this

**reason, NRC** policy does not call for retaining the NRC resident inspector during decommissioning as required during plant operation. However, given the lack of experience in large decommissioning projects to date, the NRC could consider allowing utilities to request a resident inspector on site during the first few large decommissioning projects. The costs, borne by the utility, would be small relative to direct decommissioning costs, and may help improve communications between licensees and the NRC, perhaps even leading to a smoother and less expensive process.

# Safety of Aging Nuclear Plants

## 2

Unchecked, aging degradation has the potential to reduce the safety of operating nuclear power plants. The U.S. Nuclear Regulatory Commission (NRC), the commercial nuclear power industry, and others engage in a range of activities addressing the challenges imposed by power plant aging. Many aging mechanisms are plant-specific and extensive research efforts have been developed to address them, but no technically insurmountable industry-wide safety obstacles have been identified.

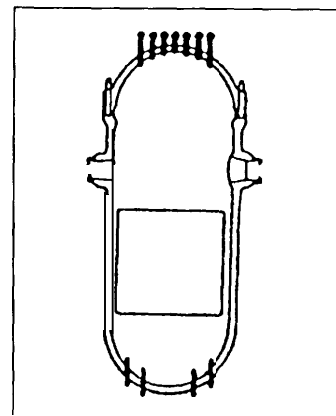
This chapter examines the safety issues related to nuclear power plants as they age. The first section describes the causes and effects of aging degradation on nuclear power plant systems, structures, and components. The second section reviews the institutions involved and their roles in assuring the safety of aging nuclear power plants. The third section describes industry and regulatory processes used to address the safety impacts of plant aging. The fourth section discusses the public and occupational health and safety goals established in current policy as they relate to aging nuclear power plants.

### THE CAUSES AND EFFECTS OF NUCLEAR POWER PLANT AGING

As defined by the NRC, aging is “the cumulative, time-dependent degradation of a system, structure, or component (SSC) in a nuclear power plant that, if unmitigated, could compromise continuing safe operation of the plant.”<sup>1</sup> The nuclear power industry takes a broader view, noting that unmitigated aging degradation can impair the ability of any SSC to perform its design function,<sup>2</sup> possibly affecting not only safety, but also the economic performance and value of a plant.

<sup>1</sup> U.S. Nuclear Regulatory Commission, *Nuclear Plant Aging Research (NPAR) Program Plan*, NUREG-1144, Rev. 2 (Washington DC: June 1991).

<sup>2</sup> MPR Associates and the Electric Power Research Institute, *Nuclear Power Plant Common Aging Terminology*, EPRI TR-100844 (Palo Alto, CA: Electric Power Research Institute, November 1992), p. C-1.



Many nuclear power plant SSCs are subject to aging degradation, which can cause a variety of changes in the physical properties of metals, concrete, electrical cables, and other materials. These materials may undergo changes in their dimensions, ductility, fatigue capacity, or mechanical or dielectric strength. Aging degradation results from a variety of physical or chemical processes such as corrosion, fatigue, fabrication defects, embrittlement, and mechanical effects

(box 2-A). These aging mechanisms can act on power plant components from high heat and pressure, radiation, and reactive chemicals. Some plant operating procedures such as changing power output and even equipment testing also create stress for plant components.

Absent effective management, aging degradation increases the probability that any SSC will fail to function properly. A failure may initiate a system transient or accident sequence, and so

### Box 2-A-Metal Aging Degradation Mechanisms

This is a partial listing of aging degradation mechanisms for metals, with examples of effects greater than anticipated in plant design and methods used to address them.

**Corrosion** is the deterioration of a material resulting from reactions with its environment. Some steam generator components, piping, pressure vessel internals, and other plant areas have experienced more extensive corrosion than originally assumed during plant design. Major forms of corrosion include wastage, stress corrosion cracking, erosion/corrosion, crevice corrosion, and intergranular attack. Methods of addressing corrosion for existing components have been developed, including inspections for signs of deterioration, control of water chemistry, or replacement with resistant materials or designs.

Fatigue is the deterioration of a material from the repeated cycles of thermal or mechanical loads or strains. The number of cycles a material will tolerate until failure is used to classify it as either low cycle (withstanding less than 10 or 10 cycles) or high cycle. Together with the number of cycles expected, the magnitude of expected cyclic loads is a key design condition. Some fatigue failures in piping and other components have occurred, often resulting from larger than anticipated loads or combinations with other degradation mechanisms (e.g., corrosion). Methods of addressing fatigue for an existing component include inspections and more accurate estimates and monitoring of the magnitude and frequency of cyclic loads.

**Fabrication defects can contribute to more rapid fatigue cracking and corrosion. Casting and forming defects and weld-related defects embedded in a material may worsen from cyclic loadings, or such defects may become exposed by corrosion.** The distribution of flaws in a material is a key consideration, and design codes specify the acceptable level of fabrication defects. Methods of addressing fabrication defects for an existing component include inspections using nondestructive examination techniques to detect embedded flaws early, and repairs when necessary.

Embrittlement is a change in a material's mechanical properties such as decreased ductility and reduced tolerance to cracks resulting from thermal aging or irradiation. Some embrittlement has been found to be more rapid than originally anticipated in plant design. Neutron irradiation of reactor pressure vessels (RPVs), for example, can lead to a more rapid loss of ductility than expected, particularly when copper and nickel are contained in RPV weld materials. Methods of addressing embrittlement for an existing component include more accurate estimates of thermal exposure and neutron fluence histories and their effects, revised operations (e.g., arranging fuel to reduce neutron flux to certain RPV regions), and component replacement or refurbishment (e.g., RPV annealing).

Mechanical effects include vibration, water hammer, and wear. Vibration and water hammer can result from fluid flows and result in loads greater than explicitly considered during design, contributing to fatigue failures and damage to pipes, valves, and pumps.

<sup>1</sup>Structural Integrity Associates, Inc., *Component Life Estimation: LWR Structural Materials Degradation Mechanisms*, EPRI NP-5461 (Palo Alto, CA: Electric Power Research Institute, September 1987).

### Box 2-B-Reactor Pressure Vessel Embrittlement

After years of neutron bombardment from the reactor core, the steel that comprises a reactor pressure vessel (RPV) can gradually lose some of its toughness in a process called embrittlement. Neutron embrittlement is exacerbated if the steel or weld materials contain trace amounts of copper or nickel. The greatest potential problem of RPV embrittlement is the threat of pressurized thermal shock (PTS). PTS leading to RPV cracking may occur during certain abnormal plant events when relatively cool water is introduced into a reactor vessel while under high pressure after a loss of coolant accident. U.S. Nuclear Regulatory Commission (NRC) requirements and the American Society of Mechanical Engineers (ASME) Code for inspection and analysis are designed to ensure that the pressure vessels are tough enough to resist cracking if PTS occurs.<sup>1</sup>

Although the role of copper and nickel in RPV embrittlement has been known for the past two decades, several older plants were constructed using weld materials with traces of those metals. Because of the original conservative

<sup>1</sup>10 CFR 50.60 et seq.; U.S. Nuclear Regulatory Commission, Regulatory Guide 1.99, Revision 2, "Radiation Embrittlement of Reactor Vessel Materials," May 1988; 10 CFR 50 Appendices A, G and H; and ASME Boiler and Pressure Vessel Code Section XI, "Rules for Inservice Inspection of Nuclear Power Plant Components."

*(Continued on next page)*

become noticeable immediately. However, not all SSC failures are readily observable. For example, the failure of an emergency diesel generator (EDG), which is not used during normal operations but is needed only for backup power if offsite power is lost, may not be noticed until it is tested or called on to supply power. Also, accidents may induce some SSC failures. For example, aging may render electrical equipment vulnerable to the conditions that arise from an accident, such as changes in humidity, chemical exposure, radiation, and temperature.<sup>3</sup>

The basic processes of nuclear power plant aging are generally, if imperfectly, understood; operating experience and research provide ongoing improvements in the scientific understanding and ability to predict and address aging effects. There is a fairly limited set of degradation mechanisms, a large commonality in materials used, and fairly similar plant operating conditions. However, due to the diversity in power plant designs, construction and materials used,

operating conditions and histories, and maintenance practices, the specific effects of aging, although similar, are unique to each plant. Even near-twin units with the same management at the same site can have substantial differences in the remaining lives of their major SSCs.

For example, consider Baltimore Gas and Electric's two 825-megawatt (MWe) Calvert Cliffs units. Construction licenses for both units were issued in July 1969, and the same principal contractor was responsible for both units. The second unit was completed only 2 years after the first and has a reactor pressure vessel (RPV) free of copper and nickel, making it relatively immune to neutron embrittlement (box 2-B). The Unit 1 RPV, however, was built before the discovery that neutron embrittlement can occur more rapidly in steels with trace amounts of copper and nickel. As a result, special procedures and mitigation measures are necessary for Unit 1 to attain its full licensed life.<sup>4</sup>

<sup>3</sup>Electrical equipment required to perform a safety function during or following a design basis event must be qualified in accordance with 10 CFR 50.49, which includes aging considerations. As discussed below, the NRC and the commercial nuclear power industry are examining the adequacy of these requirements.

<sup>4</sup>Barth Doroshuk, Principal Engineer, Nuclear Engineering Department, Baltimore Gas and Electric Co., personal communication June 9, 1992.

### Box 2-B--Reactor Pressure Vessel Embrittlement--(Continued)

engineering designs and relative youth of most plants, only one plant to date, Yankee Rowe, has faced early retirement for embrittlement-related concerns. **Fifteen other operating units** currently do not meet generic screening limits set by the NRC, and another two will similarly not satisfy the generic guidelines before the end of their licensed lives.<sup>2</sup> However, the NRC's generic screening limits are intentionally conservative and do not necessarily indicate an unacceptable level of embrittlement. Rather, failing to meet the generic limit indicates the need for a more detailed (e.g., plant-specific) **analysis** based on the ASME Code. During 1993, the NRC plans to validate licensees' plant-specific data and analyses to determine that current requirements are met.<sup>3</sup> While the NRC's preliminary assessment is that the industry RPV analyses are adequate, the differing professional opinions between NRC staff and engineers in the case of Yankee Rowe indicate some potential for a challenging process of resolution.

The NRC and the commercial nuclear power industry both perform extensive research on RPV issues! Improved analytical and nondestructive examination (NDE) methods (e.g., **to characterize better the size and distribution of RPV flaws, and the effects of cladding in crack propagation**) may help determine if conservatism in currently required margins can be reduced. In a recent report for the Electric Power Research Institute, the ASME Section XI Task Group recommended updating the current code based on improvements in such technical areas.<sup>5</sup> Several of the recommendations could result in longer estimated lives for RPVs, as more accurate methods replace conservative assumptions in the present code. If more accurate analyses indicate that mitigation is needed, the rate of embrittlement can be reduced by methods such as shielding the RPV wall, or placing the most depleted fuel nearest the RPV's most sensitive areas to reduce the rate of neutron flux. Other options for reducing PTS risks are safety system design and operating procedures that reduce the frequency and severity of challenges (e.g., controlling heat up and cool down rates, reducing pressure prior to emergency coolant injection, and heating or mixing emergency coolant).

To restore the toughness lost to embrittlement, a process called annealing has been routinely used at several nuclear **power plants in the former Soviet Union** and for U.S. naval reactors.<sup>6</sup> Annealing involves heating a vessel to sufficiently high temperatures to allow the metal to regain its original properties. No such effort has been made for commercial reactors in the United States, although EPRI and the NRC have supported research on the topic.<sup>7</sup> After witnessing and investigating a successful Soviet annealing effort, a U.S. NRC-sponsored team concluded that although there are some technical differences and issues to resolve, the basic process maybe applicable to U.S. vessels.<sup>8</sup>

Embrittlement is not the only aging mechanism that can affect RPVs. Figure 2-1 shows an NRC summary of the key degradation sites, aging causes, failure modes, and maintenance and mitigation actions for pressurized water reactor (PWR) RPVs.<sup>9</sup>

<sup>2</sup> U.S. Nuclear Regulatory Commission, "Status of Reactor Vessel issues Including Compliance with 10 CFR Part 50, Appendices G and H," SECY-93-048, Feb. 25, 1993. NRC also noted that one additional unit with an indefinitely deferred construction schedule would not meet the limit at the end of its licensed life.

<sup>3</sup> Ibid.

<sup>4</sup> U.S. Nuclear Regulatory Commission, *Proceedings of the Seminar on Assessment of Fracture Prediction Technology: Piping and Pressure Vessels*, NUREG/CP-0037 (Washington, DC: February 1991); and "Pressure Vessel Life-Cycle Management," *EPRI Journal* October/November 1991, pp. 32-33.

<sup>5</sup> ASME Section XI Task Group on Reactor Vessel Integrity Requirements, *White Paper on Reactor Vessel Integrity Requirements for Level A and B Conditions*, EPRI TR-100251 (Palo Alto, CA: Electric Power Research Institute, January 1993).

<sup>6</sup> MPR Associates, Inc., *Report on Annealing of the Novovoronezh Unit 3 Reactor Vessel in the USSR*, NUREG/CR-5760 (Washington, DC: U.S. Nuclear Regulatory Commission, July 1991).

<sup>7</sup> Oak Ridge Associated Universities, *The Longevity of Nuclear Power Systems*, EPRI NP-4208 (Palo Alto, CA: Electric Power Research Institute, August 1985), Appendix A.

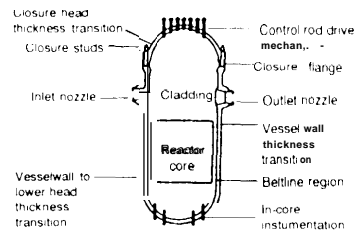
<sup>8</sup> MPR Associates, Inc., *Report on Annealing of the Novovoronezh Unit 3 Reactor Vessel in the USSR*, NUREG/CR-5760 (Washington, DC: U.S. Nuclear Regulatory Commission, July 1991).

<sup>9</sup> U.S. Nuclear Regulatory Commission, *NPAR Program plan*, NUREG-1144, Rev. 2 (Washington, DC: June 1991), p. 6.24,

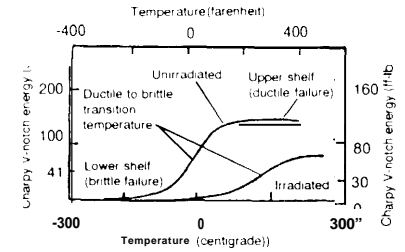


**Understanding and managing aging in PWR pressure vessels**

|                           |  |  |
|---------------------------|--|--|
| Materials                 | Vessels  | Low alloy carbon steel<br>SA-533B, SA-508-2, SA-302B   |
|                           | Cladding   | Type 308 SS and 309 SS   |
| Welements                 | Weldments  | Submerged arc (granular flux<br>Inde 80, 91, 124 and 1092<br>manganese-molybdenum nickel<br>filler wire) narrow gap submerged<br>arc, shielded metal arc, and<br>electroslag |
|                           | Closure studs  | SA-540 Gr. B24 Class 3   |
| Stressors and environment | Neutron flux and fluence, temperature, reactor coolant,<br>cyclic thermal and mechanical loads, preloads and boric<br>acid leakage |  |



Typical PWR vessel showing important degradation sites



Effect of irradiation on the Charpy impact energy for a nuclear pressure vessel steel

| UNDERSTANDING AGING<br>(materials, stressors, and environmental interaction) |   | MANAGING AGING  |   |   |
|--|---|---|---|---|
| SITES  | AGING CONCERNS  | SERVICE INSPECTION, SURVEILLANCE & MONITORING   | MITIGATION  |   |
| Beltline region  | irradiation embrittlement <ul style="list-style-type: none"> <li>chemical composition of vessel materials</li> <li>drop in upper shelf energy (USE)</li> <li>shift in reference nil-ductility-transition-temperature</li> </ul> Environmental fatigue | <b>NRC requirements</b><br>Surveillance to assess irradiation damage (shift in RT and drop in USE) (10 CFR 50 App. H, Reg. Guide 1.99, Rev. 2)<br><br>Pressurized thermal shock (PTS) screening criteria (10 CFR 50.61) PTS rule, RG 1.154<br>Damage evaluation (10 CFR 50 App. G)<br><br>Pressure-Temperature (P-T) limits during heatup, cool-down, criticality, and inservice leakage and hydrostatic pressure test to prevent nonductile fracture (Tech. Spec. requirement)<br><br>Volumetric examination of all welds during each inspection interval (10 CFR 50 App. G)<br><br>Low temperature overpressurization (LTOP) protection setpoint (technical specification requirement)<br><br>Volumetric examination of all welds during each inspection interval (10 CFR 50.55a, IWB-2500, Reg. Guide 1.150, Rev. 1)<br><br>Flaw evaluation (10 CFR 50.55a, IWB-3000)<br><br>Leakage and hydrostatic pressure tests (10 CFR 50.55a, IWA-500) | <b>Recommendations</b><br>Include fracture toughness and tensile test specimens in surveillance program<br><br>Develop use of reconstituted and miniature specimens<br><br>Develop techniques for in situ determination of mechanical properties<br><br>Perform accelerated irradiation tests of reconstituted specimens<br><br>Revise Reg. Guide 1.99 Rev. 2 to account for phosphorus with low copper<br><br>Use state-of-the-art ultrasonic inspection techniques for improved reliability of defect detection, sizing, and characterization <ul style="list-style-type: none"> <li>automated amplitude-based systems</li> <li>tip diffraction techniques</li> <li>large-diameter focused transducer</li> </ul> Use fatigue crack growth curves (ASME SC XI, Appendix A)<br><br>Develop acoustic emission monitoring to detect crack growth (appendix being developed for ASME Section XI) | Neutron flux reduction<br><br>Inservice annealing (ASTM E 509-86)<br>Determine effects of annealing and re-embrittlement rate |
| Outlet/inlet nozzles   | Environmental fatigue<br><br>Irradiation embrittlement<br>function of nozzle elevation  | Volumetric examination of all nozzle to vessel welds during each inspection interval (IWB-2500)<br><br>Volumetric and surface examination of all dissimilar metal welds during each inspection interval (IWB-2500)  | Use online fatigue monitoring (monitoring of pipe wall temperatures and coolant flows, temperatures, and pressures)<br><br>Evaluate irradiation embrittlement damage  |   |
| Instrumentation nozzles CRDM housing nozzles                                 | Environmental fatigue   | Visual examination of external weld surface of 25 percent of nozzles during system hydrostatic test (IWB-2500)  |   |   |
| Closure studs  | Environmental fatigue <ul style="list-style-type: none"> <li>preload cycles during head replacement, boric acid corrosion (if leakage occurs)</li> </ul>  | Volumetric and surface examination of all studs and threads in flange stud holes during each inspection interval (IWB-2500)   |   |   |

**Figure 2-1—Nuclear Plant Aging Research Program Summary of Pressurized Water Reactor RPV Aging Issues**

SOURCE: U.S. Nuclear Regulatory Commission, *Nuclear Plant Aging Research (NPAR) Program Plan*, NUREG-1 144, Rev. 2 (Washington, DC: June 1991, p. 6.24.

The useful lives of many power plant components, such as some pumps and valves, are shorter than the expected life of the entire plant. These components are replaced, refurbished, or repaired as part of regular maintenance efforts. In contrast, many other SSCs are designed to last the entire

life of a plant. In fact, many of these long-lived SSCs, including most RPVs and concrete structures, appear adequate for periods longer than current license terms. However, some SSCs—such as certain steam generators (box 2-C), RPVs incorporating certain materials, and certain water

### Box 2-C-Steam Generator Tube Corrosion and Cracking<sup>1</sup>

Steam generators (SGs) are integral to pressurized water reactors (PWRs), which comprise over two-thirds of U.S. plants. Weighing between 250 to 675 tons, they are large heat exchangers located within a plant's primary containment and within the reactor coolant pressure boundary to transfer energy from the radioactive primary reactor coolant to the nonradioactive secondary steam circuits that turn the turbines. Each PWR has two or more SGs depending on plant design. Although originally designed to last the life of a plant, a variety of mechanisms including corrosion, denting, cracking, and intergranular stress corrosion cracking, have been found to degrade the thousands of tubes in many SGs much more rapidly than expected. Degradation can lead to leaks of radioactive primary coolant and, in extreme cases, ruptured tubes leading to more severe plant problems. Each PWR has a unique SG degradation history due to the diversity of design and materials and conditions such as water chemistry and plant operating history.

Several methods are used to control SG degradation. Improved water chemistry is now widely used to reduce the rate of degradation. Inspections using *nondestructive* examination techniques are used to determine the condition of the tubes. When inspections detect unacceptable levels of damage (e.g., cracks greater than 40 percent of a tube's wall thickness), various repair methods are used. Plugging removes a tube from service. An alternative to plugging involves sleeving, or inserting a new tube inside the damaged portion of the original tube. Over 23,000 sleeves had been installed in domestic SGs as of 1990 (84 percent of which were at only four plants). Sleeved tubes remain subject to degradation and may later need plugging. **Heat treatment**, chemical cleaning, and other methods have also been used.

A plant can continue operating with a number of plugged tubes, as specified in plant operating manuals, although plant efficiency is reduced with increasing numbers of sleeved or plugged tubes. When too many tubes degrade too much, continued plant operation at its rated output requires steam generator replacement. Since 1981, steam generators at more than 10 plants have been replaced, and several more are under consideration. Replacement costs are high, often \$100 to \$200 million, and the work can take several months. For example, Duke Power Co. anticipates spending \$600 million on steam generator replacements for its McGuire-1 and -2 and Catawba-1 plants between 1995 and 1997. A group of nine utilities has formed the Steam Generator Replacement Group to make a volume purchase and thus reduce the replacement costs for its 16 PWRs.

The NRC and the commercial nuclear power industry continue working to improve the accuracy and applications of nondestructive examination techniques for steam generators. The NRC's standard for plugging or repairing a tube is the detection of a crack of a specific length extending through more than 40 percent of the tube. However, the NRC has approved the use of different criteria for a few plants that have microcracks, and the agency continues to investigate alternate criteria. **Figure 2-2 shows an NRC summary of the key degradation sites, aging causes, failure modes, and maintenance and mitigation actions for PWR steam generator tubes.**<sup>5</sup>

<sup>1</sup> Unless otherwise noted, this information is condensed from L. Frank, *Steam Generator Operating Experience, Update for 1989-1990*, NUREG/CR-5796 (Washington, DC: U.S. Nuclear Regulatory Commission, December 1991); and S.E. Kuehn, "A new round of steam generator replacements begins," *Power Engineering*, July 1992, pp. 39-43.

<sup>2</sup> PWR Secondary Water Chemistry Guidelines, Rev. 2, EPRI NP-6239, December 1988.

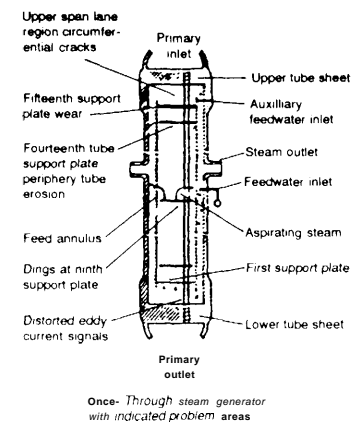
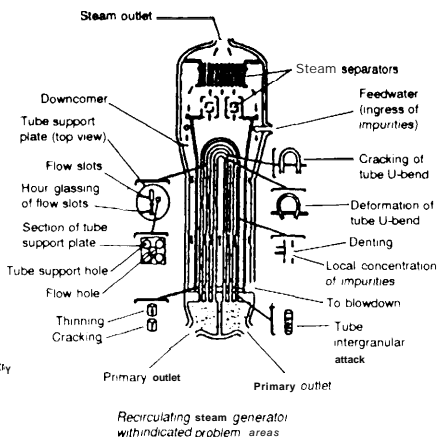
<sup>3</sup> Dijke Chooses B&W International to Supply 12 Steam Generators," *Nucleonics Week*, vol. 33, No. 27, July 2, 1992, p. 3.

<sup>4</sup> U.S. Nuclear Regulatory Commission, *Voltage-Based Interim Plugging Criteria for Steam Generator Tubes-Task Group Report*, NUREG-1477 draft (Washington, DC: June 1993).

<sup>5</sup> U.S. Nuclear Regulatory Commission, *NPAR Program P/An*, NUREG-1 144, Rev. 2 (Washington, DC: June 1991), p. 6.12.

### Understanding and managing aging of PWR steam generator tubes

|                           |   |  |
|---------------------------|---|--|
| Materials                 | Tubes   | Inconel 630 or 690   |
|                           | Tube sheet  | SA508 clad with Ni-Cr-Fe alloy (equivalent to SB 16s)                |
|                           | Tube supports   | SA 285 Gr C Ferritic SS Type 405 or 409                              |
|                           | Sleeves   | Inconel 625 or nickelbonded on outside surface if Inconel 600 or 690 |
| Steam generator types     | Plugs   | Inconel 690  |
|                           | Recirculating<br>Once-through   | Westinghouse,<br>Combustion Engineering,<br>Babcock & Wilcox         |
| Stressors and environment | Residual stresses, primary coolant chemistry (primarily hydrogen concentration) secondary coolant chemistry (chlorides, oxygen, copper, sulfates), phosphate chemistry resin leakage from condensate polisher, brackish water, temperature, flow-induced vibration, flow-velocities, and operating transients |  |



### UNDERSTANDING AGING (materials, stressors, and environmental interaction)

### MANAGING AGING

| TYPES                         | SITES   | AGING CONCERNS  |
|-------------------------------|---|---|
| Recirculating inside surface  | U bends roll transition and dented regions                                      | PWSCC (pure water SCC) tubes with low mill annealing temperature are more susceptible |
|                               | Tube plugs  | IGSCC IGA   |
| Recirculating outside surface | Hot lag tubes in tube-to tube sheet crevice region                              | Pitting   |
|                               | Cold lag side in sludge pile or where scale containing copper deposits is found | Denting   |
|                               | Tubes in tube support regions   | High-cycle fatigue  |
|                               | Inadequately supported tube if dented near the top support plate                | Fretting  |
|                               | Contact points between tube and antivibration bar                               | Wastage   |
|                               | Tubes above tube sheet  | Erosion-corrosion Fatigue   |
| Once-through Outside Surface  | Tubes   | Environmental fatigue   |
|                               | Tubes in upper tube sheet region  |   |

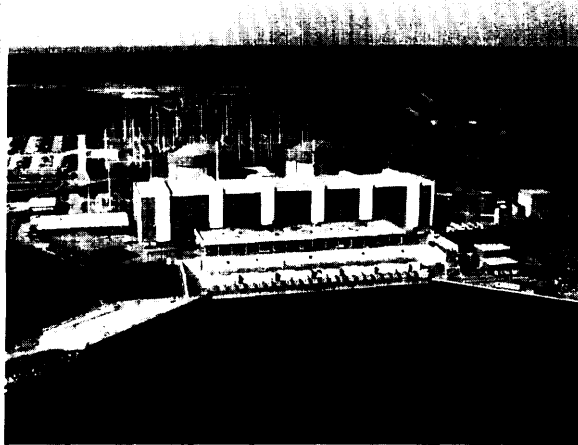
| SERVICE INSPECTION, SURVEILLANCE & MONITORING   |
|---|
| <p><b>NRC Requirements</b></p> <p>Volumetric examination of hot leg side, U-bend portion, and (optionally) cold leg side of tubes in recirculating steam generators (IWB-2500)</p> <p>Volumetric examination of the entire length of tubing in once-through steam generators (IWB-2500)</p> <p>Frequency of inspection and number of tubes to be inspected (minimum of 3 percent of all tubes) are determined by technical specifications (Reg. Guide 1.83)</p> <p>Standards for allowable flaws in recirculating steam generators (standards for once-through steam generators are being prepared) (IWB-3521)</p> <p>Flaw acceptance criteria determined by technical specifications (IWB-3630)</p> <p>Criteria for determining necessity of plugging degraded tubes (Reg. Guide 1.121)</p> <p>Unscheduled inservice inspection of each steam generator is required when primary to secondary tube leaks exceed the limits defined in technical specifications</p> |
| <p><b>Recommendations</b></p> <p>Follow Steam Generator Owners' Groups' guidelines for continuous monitoring and control of secondary water chemistry</p> <p>Reduce uncertainties in inspection results and quantify flaw growth rates</p> <p>Monitor field performance of various sleeve designs</p> <p>Perform inservice inspection of tube plugs</p>   |

| MITIGATION   |
|--|
| Prevent transient conditions in secondary water chemistry, install filters between condensate polishers and steam generators. Use ultrafiltration of makeup water and remedy condenser leakage as quickly as possible  |
| Use shotpeening and rotopeening to introduce compressive residual stresses on tube inner surface in the roll transition region, and anneal U-bends to reduce PWSCC   |
| Apply nickel plating on the inner surface of the tubes to prevent PWSCC crack initiation and propagation   |
| Use tube rolling to eliminate tube sheet crevices and use crevice flushing, crevice alkalinity neutralization, alkaline impurity control, acid chloride elimination, hot soaks, sludge lancing, pressure pulse, water slap, chemical cleaning, and boric acid additions to control IGA/IGSCC |
| Eliminate copper pickup by use of titanium or stainless steel condenser tubes and replace the copper-bearing alloys in the feedwater train to reduce pitting and denting   |
| Use all-volatile treatment water chemistry, sludge lancing, chemical cleaning, hot soaks, hot blowdown and flushing and elimination of hideout chemical concentration to control wastage   |
| Use chemistry control to prevent concentration of impurities leading to fatigue crack initiation in once-through steam generators  |
| Use lane-flow blocker in once-through steam generators to mitigate environmental fatigue   |

**Figure 2-2—Nuclear Plant Aging Research Program Summary of Pressurized Water Reactor Steam Generator Tubes Aging Issues**

SOURCE: U.S. Nuclear Regulatory Commission, *Nuclear Plant Aging Research (NPAR) Program Plan*, NUREG-1144, Rev. 2 (Washington, DC: June 1991), p. 6.30.

PHOTO CREDIT: BALTIMORE GAS AND ELECTRIC CO.



*Life-cycle management activities at Baltimore Gas and Electric Co.'s 2 Calvert Cliffs nuclear power plants could be useful in future license renewal efforts.*

system piping—may experience more rapid aging degradation than originally anticipated in plant designs. Because few nuclear power plants are in the second half of their 40-year licensed lives, operating experience with the aging of long-lived SSCs remains limited.

### **INSTITUTIONS FOR ASSURING THE SAFETY OF AGING PLANTS**

Under the Atomic Energy Act of 1954 (AEA),<sup>5</sup> as amended, the NRC is responsible for regulating civilian nuclear power facilities ‘to assure the common defense and security and to protect the health and safety of the public.’<sup>6</sup>To ensure the safety of operating nuclear plants, the NRC performs a variety of activities, including the development and documentation of the ‘licensing bases’ that specify plant design requirements and operation and maintenance (O&M) practices;

the inspection and enforcement of license requirements; the performance of technical research and analysis; and the modification of regulatory requirements as needed. All of these activities are involved in addressing power plant aging to assure safe operations.

Although the NRC plays a central role in assuring nuclear power plant safety, the AEA actually assigns the primary responsibility for the safe operation of a commercial nuclear plant with the plant operator, or licensee.<sup>7</sup>Each licensee is ultimately responsible for the design, operation, and maintenance of its plant—not only to meet NRC requirements but to assure safety. To pool resources, share experiences, and coordinate efforts, the U.S. nuclear electric utilities have established several industry-wide organizations concerned with safety and other issues. Notable among them are the Electric Power Research Institute (EPRI), the Institute of Nuclear Power Operations (INPO), and the Nuclear Management and Resources Council (NUMARC).

EPRI was formed in 1973 to perform research and development (R&D) for a broad range of electric utility industry technologies, including nuclear power production. As discussed below, EPRI has sponsored a great deal of R&D directly related to nuclear plant aging issues over the last two decades, ranging from basic material science to improved maintenance practices. The organization helped prepare several of the 10 ‘industry reports’ on license renewal that were eventually submitted to the NRC by NUMARC. Most, but not all, nuclear utilities are EPRI members. As of 1992,<sup>7</sup> utilities operating 23 of the Nation’s 107

<sup>5</sup> Atomic Energy Act of 1954, Public Law 83-703, 68 Stat. 919.

<sup>6</sup> These responsibilities were originally granted to the Atomic Energy Commission (AEC). The Energy Reorganization Act of 1974 (Public Law 93-438) transferred these responsibilities from the AEC to the U.S. Nuclear Regulatory Commission (NRC).

<sup>7</sup> 42 U.S.C. 2011 *et seq.*

operating nuclear power plants were not members.<sup>8</sup>

INTO was formed in 1979 in the aftermath of the accident at Three Mile Island Nuclear Station “to promote the highest levels of safety and reliability—to promote excellence—in the operation of nuclear electric plants.” All commercial operators of nuclear power plants in the United States are members. INPO performs evaluations of plant practices, a form of self-regulation by peer review. The organization also conducts training and information exchange for its members. To promote effectiveness and encourage better information exchanges between member utilities, much of INPO’s utility-specific work is conducted as private transactions with its members,<sup>10</sup> although some of its reports are provided to the NRC on a confidential basis.<sup>11</sup> Some INPO activities address aging-related issues, such as promoting excellence in maintenance practices, performing regular, onsite evaluations of plant facilities and practices, and analyzing operating events.

NUMARC, formed in 1987, acts as a liaison between the nuclear power industry and the NRC and other safety regulators on generic regulatory and technical issues. All U.S. nuclear utilities are members. Other nuclear industry organizations such as nuclear steam supply system vendors and architect-engineering firms also participate in

NUMARC efforts. The organization has played an active role in addressing nuclear power plant aging safety issues, including major contributions in the development and implementation of NRC’s maintenance and license renewal rules.

Professional societies such as the American Society of Mechanical Engineers (ASME), the Institute for Electrical and Electronics Engineers (IEEE), the American Society of Civil Engineers, and American Society of Testing and Materials have developed codes and standards for the design, maintenance, and analysis of various SSCs. Code-writing committees affiliated with these societies include individuals from utilities, vendor firms, consultants, academia, and the NRC. Several codes developed by these societies for SSC design, qualification, and maintenance have been incorporated in NRC rules.

The public and State governments also have a role in promoting the safety of existing nuclear power plants. As required by the AEA and the Administrative Procedure Act, as amended,<sup>12</sup> the NRC solicits public comment when developing new rules and regulations. The contribution is often extensive. For example, NRC’s draft rule for nuclear power plant license renewal drew nearly 200 sets of comments, including 75 from individuals, 42 from manufacturing and engineering firms, 40 from utilities and utility organizations, 19 from public interest groups, 8 from State

---

<sup>8</sup> Nonmembers as of December 1992 (and the number of nuclear power plants operated by each) include Commonwealth Edison (12 units); Virginia Power (4 units); Southern California Edison (2 units); Indiana and Michigan Electric (2 units); Detroit Edison (1 unit); Kansas Gas and Electric (1 unit); and Washington Public Power Supply System (1 unit). *Electric Power Research Institute 1992 Annual Report* (Palo Alto, CA: 1993), pp. 36-40; and U.S. Department of Energy, *Nuclear Reactors Built, Being Built, or Planned: 1991*, DOE/OSTI-8200-R55 (Washington, DC: July 1992).

<sup>9</sup> Institute of Nuclear Power Operations, “Institutional Plan for the Institute of Nuclear Power Operations, 1990,” p. 5.

<sup>10</sup> *Ibid.*, app. B.

<sup>11</sup> This practice has drawn some criticism. For example, according to the U.S. General Accounting Office (GAO), on at least 12 occasions during 1989 and 1990 the NRC decided not to issue publicly available information notices after it was given access to INPO documents that were unavailable to the public. U.S. Congress, General Accounting Office, *NRC’s Relationship With the Institute of Nuclear Power Operations*, GAO/RCED-91-122 (Gaithersburg, MD: May 1991), p. 7. One public interest group filed a legal suit to gain access to INPO documents. However, NRC’s practice of using confidential information has been affirmed by the U.S. Court of Appeals, finding no “reason to interfere with the NRC’s exercise of its own discretion in determining how it can best secure the information it needs. United States Court of Appeals, Critical Mass Energy Project, Appellant, v. Nuclear Regulatory Commission et al., 975 F.2d 871 (D.C. Cir. 1992), Aug. 21, 1992.

<sup>12</sup> 5 U.S.C. 551 *et seq.*

agencies, and 4 from other Federal agencies.<sup>13</sup> These comments led to several substantive revisions in the proposed rule.<sup>14</sup> Similarly, comments on the NRC's proposed maintenance rule<sup>15</sup> also led to changes prior to its final promulgation in July 1991.

The public may participate in NRC licensing actions associated with operating nuclear power plants that the NRC or the licensee initiates, although some observers have suggested that NRC policies have been too restrictive for public input to help address many important safety issues.<sup>16</sup> When a reactor licensee formally requests a modification or renewal of its NRC license, the public may request a hearing and intervene in the case, subject to certain administrative restrictions. For example, the public may request a hearing in the case of a license renewal application, but the scope of such hearings is limited to circumstances unique to the renewal term.<sup>17</sup> The ultimate effect of public input during NRC's deliberations over license renewal applications remains to be seen and is likely to vary by plant. Past experience with new plant licensing indicates that the role of both local and national public interest groups can be substantial.<sup>18</sup>

In contrast to the extensive opportunities for public participation in the development of new rules or during licensing actions initiated by the NRC or licensees, NRC regulations place strict

limits on the public's ability to initiate proceedings to modify, suspend, or revoke a license. NRC regulations allow any person to file an enforcement petition with the Executive Director for Operations (EDO), a member of the NRC staff, specifying the action requested and the basis for the request. The EDO's decision in the case is subject to review of the Commission, although "No petition for Commission review of a Director's decision will be entertained by the Commission."<sup>19</sup> These restrictions on petitioners' **opportunities** to seek Commission and judicial review have been criticized as limiting the public role in assuring plant safety. Although the requests in most public petitions have been denied, they can have notable impacts, as in the case of Yankee Nuclear Power Station (box 2-D).

Because of the technical complexity of many nuclear power issues, and because the perspectives of stakeholders can differ substantially, resolving differing opinions when new issues are raised can involve a lengthy process. For example, in developing and implementing license renewal policies, the NRC and the commercial nuclear power industry are reviewing the experience of lead plants and other related industry efforts before detailed renewal practices are finalized.

Some observers suggest that the regulatory process itself is overly cumbersome and exacerbates uncertainty.<sup>20</sup> According to one NRC survey

<sup>13</sup> U.S. Nuclear Regulatory Commission, *Analysis of Public Comments on the Proposed Rule on Nuclear Power Plant License Renewal*, NUREG-1428 (Washington DC: Oct. 5, 1991), Appendix A.

<sup>14</sup> 56 *Federal Register* 64943 *et seq.* (Dec. 13, 1991).

<sup>15</sup> 10 CFR 50.65.

<sup>16</sup> Michelle Adato, *The Union of Concerned Scientists, Safety Second: The NRC and America's Nuclear Power Plants* (Indianapolis, IN: Indiana University Press, 1987).

<sup>17</sup> This limitation is consistent with NRC's principles for the license renewal robust that the current licensing basis provides adequate protection of the public health and safety.

<sup>18</sup> U.S. Congress, Office of Technology Assessment, *Nuclear Power in an Age of Uncertainty*, OTA-E-216 (Washington, DC: U.S. Government Printing Office, February 1984), ch. 8.

<sup>19</sup> 10 CFR 2.206.

<sup>20</sup> M.W. Golay, "How Prometheus Came to be Bound: Nuclear Regulation in America," *Technology Review*, June/July 1980, pp. 29-39. Although the article was written some time ago, the author contends that most of its themes remain pertinent. Personal communication January 1993.

### Box 2-D-Yankee Rowe

Until its early retirement in February 1992, the Yankee Rowe nuclear powerplant, a relatively small (185 MW) PWR in Massachusetts, was the Nation's oldest operating plant. The plant began operation in 1960 and was expected to be the first to file an NRC license renewal application. During an NRC staff review of license renewal documents, questions about the ability of the pressure vessel to withstand a pressurized thermal shock (PTS) were raised.

In a petition filed with the NRC, the Union of Concerned Scientists asked for an immediate shutdown of the plant.<sup>1</sup> The petition emphasized several factors previously identified by NRC staff in its license renewal efforts. Yankee Rowe's case raised unique concerns related to the plant's age. For example, the pressure vessel was constructed before the susceptibility to neutron embrittlement of steel containing copper and nickel was fully understood. As a result, those elements may have been included in the vessel's weld material, although the extent of their presence was unknown. Further, due to the unique cladding of the vessel, ultrasonic testing of the vessel for cracks or flaws was not possible using conventional techniques.

Although shutdown request by the Union of Concerned Scientists was denied, the NRC initiated a review of the plant's PRA, which ultimately found that because of the uncertainties, the risk may have been greater than previously estimated.<sup>2</sup> The NRC revised its analysis to reflect the postulated detrimental effects of the vessel's metal cladding and made more conservative assumptions of potential cracks and the density of flaws in the vessel and welds. The NRC staff recommended shutting the plant until testing of actual plant conditions could be performed and the uncertainties resolved. This testing would involve applying specialized methods for obtaining samples of the weld materials, and for positioning ultrasonic testing equipment in the 2-inch gap between the vessel and cladding. Yankee Atomic Electric Co. concluded that the novel testing methods necessary to verify the integrity of the reactor vessel, estimated to cost \$23 million, were not economically justified and voluntarily removed the plant from service and officially retired it 4 months later.<sup>3</sup>

<sup>1</sup> Union of Concerned Scientists, letter to U.S. Nuclear Regulatory Commission, "Petition for Emergency Enforcement Action and Request for Public Hearing Before the Nuclear Regulatory Commission," June 4, 1991.

<sup>2</sup> U.S. Nuclear Regulatory Commission, *In the Matter of Yankee Atomic Electric Company: Memorandum and Order, CLI-91-11*, July 31, 1991.

<sup>3</sup> "NRC Staff, Yankee Atomic Continue Reactor Safety Debate," *The Energy Daily*, Oct. 4, 1991, p. 4.

of industry members, respondents noted that "licensees acquiesce to NRC requests even if the requests require the expenditure of significant licensee resources on matters of marginal safety significance. Further, survey respondents noted that the "NRC so dominates licensee resources through its existing and changing formal and informal requirements that licensees believe that their plants, though not unsafe, would be easier to operate, have better reliability, and may even

achieve a higher degree of safety, if they were freer to manage their own resources."<sup>21</sup>

### SAFETY PRACTICES ADDRESSING AGING

The practices necessary to manage nuclear power plant aging are elaborate, beginning with plant design and analysis and extending to a variety of maintenance and research activities. This section reviews the safety practices used to manage plant aging.

<sup>21</sup> U.S. Nuclear Regulatory Commission, *Industry Perceptions of [the Impact of the U.S. Nuclear Regulatory Commission on Nuclear Power Plant Activities]*, draft report, NUREG-1395 (Washington DC: March 1990), pp. xxix.

## ■ Nuclear Power Plant Design and Aging

Aging management begins with plant design. Many design criteria explicitly or implicitly address aging. The long-lived SSCs in a nuclear plant, for example, were originally designed with sufficient margins to meet minimum lifetime requirements. Nuclear power plant piping systems are designed with industry codes based on assumed service conditions, with some allowance for pipe wall thinning from erosion and corrosion. In addition, fatigue analyses used to establish design criteria for piping, pumps, and valves estimate the number of on/off cycles a power plant experiences during its life, as well as the resulting temperature variations and thermal stresses from those cycles.

To account for a variety of engineering uncertainties at the time of plant design, original SSC designs were generally based on what were then thought to be conservative assumptions of operating and material conditions.<sup>22</sup> Since the early plants were designed and fabricated, decades of experience and research have determined that some design assumptions were in fact not conservative, while others were. As this experience suggests, aging degradation rates for SSCs are in some cases quite different than originally anticipated.

Over the past several decades, improvements in analytical and material examination techniques have allowed the review of original plant design bases for more accurate assessments of aging degradation. More accurate predictive methods may allow for less conservatism in assessing the adequacy of SSC performance and predicting

their remaining useful life. Some plants, particularly older ones, may lack the information needed for more accurate analyses. At Yankee Rowe, for example, the amount of copper in the RPV weld material was unknown, preventing any ready determinations of potential embrittlement problems. Many utilities have programs to improve the availability and retrievability of design information, including efforts to reconstitute design documents that were not adequately preserved.<sup>23</sup>

Technical understanding, industry practices, and NRC design requirements have become more rigorous since the 1960s. Prior to 1967, Atomic Energy Commission (AEC)<sup>24</sup> nuclear power plant regulations contained relatively sparse design detail. In 1971, the AEC adopted “General Design Criteria (GDC) for Nuclear Power Plants,” now contained in 10 CFR Part 50, Appendix A. The GDC established minimum requirements for materials, design, fabrication, testing, inspection, and certification of all important plant safety features. The next year, a draft “Standard Format and Content of Safety Analysis Reports for Nuclear Power Plants” provided more detailed guidance and requirements for implementing the GDC.<sup>25</sup> Additional guidance was contained in the Standard Review Plan, originally released in 1975 and revised in 1981.<sup>26</sup>

Codes from professional societies that are incorporated by reference in NRC regulations have also changed substantially over the past decades. For example, ASME codes for pressure vessel design, fabrication, and operating limits<sup>27</sup> evolved considerably from the 1960s through 1973, and in-service inspection requirements<sup>28</sup>

<sup>22</sup> ASME Section XI Task Group on Reactor vessel Integrity Requirements, *White Paper on Reactor Vessel Integrity Requirements for Level A and B Conditions*, EPRI TR-100251 (Palo Alto, CA: Electric Power Research Institute, January 1993), pp. 1-1 to 1-12.

<sup>23</sup> Nuclear Management and Resources Council, *Design Basis Program Guidelines*, NUMARC 90-12 (Washington DC: October 1990); and U.S. Nuclear Regulatory Commission, “Design Document Reconstitution” SECY-91-364, Nov. 12, 1991.

<sup>24</sup> Regulatory authority and responsibilities were transferred to the NRC by the Energy Reorganization Act of 1974 (Public Law 93-438).

<sup>25</sup> U.S. Nuclear Regulatory Commission Regulatory Guide 1.70 is the final version of that draft document.

<sup>26</sup> U.S. Nuclear Regulatory Commission, *Standard Review Plan*, NUREG-0800 (Washington, DC: July 1981).

<sup>27</sup> American Society of Mechanical Engineers, ASME Code, Section III.

<sup>28</sup> American Society of Mechanical Engineers, ASME Code, Section XI.



were introduced in 1970.<sup>29</sup> Similarly, IEEE standards for electrical equipment issued in 1971 were substantially revised in 1974.<sup>30</sup>

Some observers have suggested that the safety of older plants is inadequate, because they were not designed with the same detailed guidance as newer plants and therefore often do not meet the current design standards.<sup>31</sup> However, the commercial nuclear power industry and the NRC note that the NRC judges safety for older plants on an ad hoc and plant-specific basis, rather than a standardized basis, and the NRC finds that adequate safety currently exists. To review and ensure the safety of older plants, the NRC created the “Systematic Evaluation Program” (SEP) in 1977. According to the NRC, the SEP review of approximately 90 topics necessitated some specific procedural or hardware modifications (‘back-fits’), and additional analyses for the older plants provided “reasonable assurance that they can be operated without undue risk to the public health and safety, which is the same standard for new plants.”<sup>32</sup>

## ■ Maintenance Practices Addressing Aging

Effective maintenance programs are crucial to manage aging degradation. Maintenance involves a variety of methods to predict or detect aging degradation and other causes of SSC failure, and to repair or replace any affected SSCs. Both NRC rules and industry codes contain maintenance requirements. For example, the ASME Boiler and

Pressure Vessel Code Section XI specifies in-service inspection methods, which are incorporated in NRC rules.<sup>33</sup> Before 1991, there were no specific NRC maintenance requirements for many SSCs important to safety. To “ensure the continuing effectiveness of maintenance for the lifetime of nuclear power plants, particularly as plants age,” the NRC adopted a maintenance rule in 1991 to become effective in 1996.<sup>34</sup> The rule directs Licensees to establish performance goals for SSCs important to safety and to monitor the condition or performance of those SSCs, or otherwise control degradation through preventive maintenance. The requirements are relatively flexible and do not specify performance criteria (e.g., the frequency of testing or surveillance), and the rule does not require a detailed regulatory approval of the criteria licensees establish.

The maintenance rule was promulgated after several years of increasing NRC and industry attention to maintenance.<sup>35</sup> While the NRC was evaluating the need for a maintenance rule, INPO developed guidelines for effective maintenance to guide utility practices.<sup>36</sup> As a result, the industry argued that the NRC rule was unnecessary and duplicated current practices established by INPO. In promulgating its rule, the NRC noted that its recent inspections of maintenance activities found that existing programs were adequate and improving, but there were some areas of weaknesses, and NRC found that no licensee had formally committed to implement the INPO

<sup>29</sup> ASME Section XI Task Group on Reactor Vessel Integrity Requirements, *White Paper on Reactor Vessel Integrity Requirements for Level A and B Conditions*, EPRI TR-100251 (Palo Alto, CA: Electric Power Research Institute, January 1993), pp. 1-1 to 1-12.

<sup>30</sup> Institute of Electrical and Electronics Engineers Standard, “Criteria for Protection Systems for Nuclear Power Generating Stations,” (IEEE-279), incorporated by reference in 10 CFR Part 50.55a(h).

<sup>31</sup> See, e.g., Diane Curran, Counsel for Union of Concerned Scientists, *Hearings Before the Subcommittee on Energy and the Environment of the Committee on Interior and Insular Affairs*, House of Representatives, Nov. 5, 1991, pp. 93-95.

<sup>32</sup> U.S. Nuclear Regulatory Commission, *Foundation for the Adequacy of the Licensing Bases*, NUREG-1412 (Washington, DC: December 1991), p. 1.5.

3310 CFR 50.55a.

3410 CFR 50.65.

<sup>35</sup> U.S. Congress, General Accounting Office, *NRC’s Efforts to Ensure Effective Plant Maintenance Are Incomplete* GAO/RCED-91-36 (Gaithersburg, MD: December 1990).

<sup>36</sup> Institute of Nuclear Power Operations, “Maintenance Programs in the Nuclear Power Industry,” INPO 90-008, March 1990.

standards prior to the rule's proposal.<sup>37</sup> NUMARC later submitted the INPO guidelines to the NRC as an industry standard suitable for compliance with the maintenance rule. The group also coordinated a validation and verification effort of the maintenance approach at several nuclear plants, and the NRC found them to describe adequately the attributes necessary to comply with the maintenance rule.<sup>38</sup>

There have been significant advances in nuclear plant maintenance technologies in the last two decades in all areas, including surveillance, testing, and inspection of important SSCs subject to degradation; methods to plan repair, replacement, and other maintenance activities; and actual SSC repair and replacement methods. All are important to ensure that aging degradation does not unduly reduce plant safety margins and performance. There is a wide variety of specific inspection, surveillance, testing, and monitoring techniques used for the many different plant SSCs. Examples of improved maintenance techniques for two major long-lived SSCs are given in boxes 2-B (RPV embrittlement) and 2-C (steam generator tube corrosion and cracking).

Effective maintenance requires the careful planning and design of maintenance programs. Two areas of improved planning approaches are: 1) predictive and reliability-centered maintenance (RCM)<sup>39</sup>; and 2) risk-focused maintenance (RFM). RCM involves the use of prediction and inspection techniques to repair or replace degraded critical equipment prior to its failure.<sup>40</sup>

Absent a reliability-based approach, much maintenance work focuses on either repairing failed equipment as it occurs or repairing or replacing equipment long before it wears out. In addition to placing heavy reliance on the defense-in-depth approach designed into nuclear plants (e.g., redundancy of important safety items), reactive maintenance in the extreme results in more plant shutdowns and less coordination of maintenance with fuel cycle outages. At the other extreme, premature replacement of properly functioning SSCs represents an unnecessary cost and increase the potential for maintenance errors. RCM involves inspection and repair before SSCs wear out but avoids excessive repair work through monitoring and predictive techniques. The RCM concept continues to evolve, for example, in selecting an appropriate level of detail (e.g., to examine systems or individual components).<sup>41</sup> RCM efforts, involving either pilot programs or significant investments, are under way at about half of the nuclear plants in the United States.<sup>42</sup> NRC's regulatory guide for the maintenance rule encourages utilities to consider reliability-based methods of predictive maintenance.<sup>43</sup>

RFM uses probabilistic risk assessment (PRA) methods to determine which SSCs subject to degradation are most important to safety and performance and thus which should receive the greatest maintenance attention.<sup>44</sup> For example, rather than perform an equal number of tests or inspections on all of the many valves in a nuclear power plant, those most important to reducing or

<sup>37</sup> 56 FR 132, July 10, 1991, p. 31321.

<sup>38</sup> Nuclear Management and Resources Council, *Industry Guidelines for Monitoring Effectiveness of Maintenance at Nuclear Power Plants*, NUMARC 93-01 (Washington DC: May 1993); 56 Federal Register 31312 (July 10, 1991); and U.S. Nuclear Regulatory Commission, Regulatory Guide 1.160, June 1993.

<sup>39</sup> NUS Corporation, *Predictive Maintenance Primer*, EPRI NP-7205 (Palo Alto, CA: Electric Power Research Institute, April 1991).

<sup>40</sup> For equipment not critical to safety, the prescribed maintenance approach may well be one of running until failure.

<sup>41</sup> "NUMARC Wants N. Utilities Moving Early on Maintenance Rule Work," *Nucleonics Week*, vol. 33, No. 42, Oct. 15, 1992, PP. 1, 13.

<sup>42</sup> D.H. Worledge, "Nuclear Industry Embraces Reliability-Centered Maintenance," *Power Engineering*, July 1993, pp. 25-28.

<sup>43</sup> U.S. Nuclear Regulatory Commission, Regulatory Guide 1.160, June 1993.

<sup>44</sup> E.V. Lofgren et al., *A Process for Risk-Focused Maintenance*, NUREG/CR-5695 (Washington, DC: U.S. Nuclear Regulatory Commission, March 1991).

mitigating accident risks are inspected more frequently. RFM is also applied to EDG testing; during any cold start for an engine such as a diesel generator, the thermal stresses and mechanical wear from the initial lack of lubrication contributes to substantial degradation and the potential for premature failure. One RFM application has allowed plant operators to reduce the frequency of cold start EDG testing, while increasing the testing of other emergency generator components and support equipment, such as the starter systems. The result: longer and more reliable lives for the EDGs and a higher expected availability when they are actually needed.

Degradation detection methods for many SSCs typically have imperfect accuracy,<sup>45</sup> a factor to consider when designing maintenance practices. Improved testing and inspection techniques continue to be developed, allowing more accurate and earlier detection of flaws and other material characteristics, and improving the likelihood of preventing the failure of important SSCs. New nondestructive examination (NDE) methods—including ultrasonic, eddy-current, and radiographic inspections of pressure vessels, steam generators, piping, containment and other SSCs—allow more accurate SSC evaluations than previously possible.<sup>46</sup> For example, new NDE methods based on magneto-optic imaging allow examination of containment welds for cracking, even when these welds are beneath paint coatings.<sup>47</sup>

In addition, new methods are under development to examine some important SSCs that currently preclude testing or inspection due to

basic physical limitations (e.g., limited access or space). New robotic technologies and other specialized inspection machines allow better access to confined or high radiation areas.<sup>48</sup> Robotics applications include underwater visual inspections using submersible vehicles with cameras, internal inspection of piping using power crawlers, and cleaning RPV internals and steam generators. After detecting cracks in RPV head penetrations at its Bugey-3 nuclear power plant, for example, Electricity de France (EDF) decided to inspect these penetrations at all 59 of its pressurized water reactors (PWRs). To reduce the substantial occupational exposures resulting from the detailed inspections, EDF worked with equipment vendors to develop a specialized robotic inspection device to reduce exposures substantially.<sup>49</sup> The use of robotics in maintenance activities is increasing, but improvements in precision, dexterity, and mobility could increase their usefulness further.

Unanticipated degradation rates have inspired new repair and replacement methods for some major SSCs. In some cases, such as with some PWR steam generators and boiling water reactor (BWR) recirculation piping, these methods have become widespread. However, replacing or repairing some SSCs may not be economically or technically practical. Even where replacement or repair is infeasible, life-limiting challenges may be addressed through revised O&M practices; such changes may reduce stresses on a vulnerable SSC or may involve more regular monitoring to detect incipient failure.

---

<sup>45</sup> See, for example, Pacific Northwest Laboratory, *Ultrasonic Inspection Reliability for Intergranular Stress Corrosion Cracks*, NUREG/CR-4908 (Washington DC: U.S. Nuclear Regulatory Commission, July 1990).

<sup>46</sup> J.A. Jones Applied Research Co., *Nondestructive Evaluation Sourcebook*, EPRI NP-7466-M (Palo Alto, CA: Electric Power Research Institute, September 1991).

<sup>47</sup> Physical Research, Inc., *Two New NDT Techniques for Inspection of Containment Welds Beneath Coating*, NUREG/CR-5551 (Washington DC: U.S. Nuclear Regulatory Commission, June 1991).

<sup>48</sup> Utility/Manufacturers Robot Users Group, *Survey of Utility Robotic Applications (1990)*, EPRI NP-7456 (Palo Alto, CA: Electric power Research Institute, August 1991).

<sup>49</sup> "Nuclear Industry Deflects Greenpeace on Cracking Issue," *Nucleonics Week*, vol. 34, No. 13, Apr. 1, 1993, pp. 1,9-12. The U.S. nuclear power industry and the NRC expect to begin detailed inspections of PWR RPV head penetrations in 1994 when specialized machines become available.

Maintenance technologies continue to evolve, and greater experience and implementation hold the promise of safer, more reliable, and less costly operations. To transfer the results of maintenance R&D, EPRI has established a Nuclear Maintenance Applications Center in North Carolina.<sup>50</sup> The Center provides a forum to impart EPRI research findings and assists with training and information exchange for nuclear utilities.

### ■ Aging Research

Both the commercial nuclear power industry and the NRC view continued aging research and analysis of operating experience as important to help assure adequate safety. Both the industry and the NRC perform research on a broad range of aging topics, including basic materials science, studies of specific components and degradation mechanisms, new maintenance practices, and analytical techniques.

Since its inception in 1973, EPRI has devoted about 15 percent of its Nuclear Power Division budget to understanding, detecting, and mitigating degradation processes for nuclear power plant components.<sup>51</sup> The 1992 EPRI R&D plan included over \$130 million in nuclear power activities.<sup>52</sup> Similarly, the AEC and its successor, the NRC, have conducted research on materials aging since 1960. About 25 percent of the current \$100 million annual NRC research budget is dedicated to aging research.<sup>53</sup> Most NRC aging research is performed through Depart-

ment of Energy (DOE) national laboratories. Aging research is also conducted by some international organizations and other nations with nuclear power plants.<sup>54</sup>

The goals of safety-related aging research are varied and include the following:

- understanding SSC aging effects that could impair plant safety if unmitigated;
- developing inspection, surveillance, monitoring, and prediction methods to ensure timely detection of aging degradation;
- evaluating the effectiveness of operating and maintenance practices to mitigate aging effects; and
- providing the technical bases for license renewal.<sup>55</sup>

Absent actual, long-term operating experience for long-lived SSCs, scientific understanding of aging issues involves engineering analyses and research, often using simulation techniques to accelerate aging on test materials.<sup>56</sup> Retired plants may also yield lessons about aging by providing naturally aged SSCs to study. For example, the NRC, the DOE and the commercial nuclear power industry are coordinating efforts to examine materials from the retired Yankee Rowe plant, which operated for 30 years, to aid in aging research.<sup>57</sup> However, the diversity among plants and their SSCs prevents simple generalizations about the ultimate effects and management of aging. In contrast, for shorter lived SSCs, engi-

<sup>50</sup> See, for example, Electric Power Research Institute, *EPRI Research Publications, Products, and Expertise in Maintenance*, EPRI NP-7014 (Palo Alto, CA: May 1991).

<sup>51</sup> John Carey, Electric Power Research Institute, personal communication, January 1993.

<sup>52</sup> See, for example, Electric Power Research Institute, *Research and Development Plan 1993*, (Palo Alto, CA: 1993).

<sup>53</sup> U.S. Nuclear Regulatory Commission, *Budget Estimates Fiscal Years 1994-1995*, NUREG1100, vol. 9 (Washington, DC: April 1993), pp. 48, 51.

<sup>54</sup> See International Atomic Energy Agency, *Safety Aspects of the Aging and Maintenance of Nuclear Power Plants*, (Vienna, Austria: 1988); and International Atomic Energy Agency, *Safety Aspects of Nuclear Power Plant Ageing*, IAEA-TECDOC-540 (Vienna, Austria: 1990).

<sup>55</sup> U.S. Nuclear Regulatory Commission, *Nuclear Plant Aging Research (NPAR) program Plan*, NUREG-1144 Rev. 2 (Washington, DC: U.S. Nuclear Regulatory Commission, June 1991), p. 1.4.

<sup>56</sup> University of Connecticut, *Natural Versus Artificial Aging of Nuclear Power Plant Components*, EPRI TR-100245 (Palo Alto, CA: Electric Power Research Institute, January 1992).

<sup>57</sup> *Federal Register* 8998-8999 (Feb. 18, 1993).

neering analyses and aging research are supported better by actual operating experience.

According to the NRC, “there are significant uncertainties about aging degradation processes and about whether time-related degradation can be detected and managed before safety is impaired.”<sup>58</sup> However, no incurable safety problems have yet been identified by NRC aging research studies. Rather, NRC research has improved the understanding of aging issues and the adequacy of maintenance efforts. These research findings are transferred to NRC regulatory activities, including plant inspections and revisions of technical specifications.<sup>59</sup> Figure 2-3, which shows the results of research on BWR recirculation piping, provides one example of how information gained from aging research has influenced regulatory and operating practices. As of 1991, the NRC anticipated the completion of its Nuclear Plant Aging Research (NPAR) program as currently formulated by 1997 (‘box 2-E), although that schedule is not firm (tables 2-1 and 2-2).<sup>60</sup> Even with the completion of the NPAR program, research will be needed to examine new maintenance methods and to address any new issues identified through operating experience and past research.

The results of generic SSC aging evaluations relevant to license renewal are documented in 10 industry reports produced with industry and DOE funds. The reports were produced by EPRI and DOE’s Sandia National Laboratory for NUMARC, and NUMARC submitted them to the NRC for an evaluation of their applicability for utilities submitting renewal applications. These reports are intended to examine all plausible

aging degradation mechanisms, and identify combinations of components and degradation mechanisms for which existing programs do not effectively manage the degradation. Consistent with the results of NRC’s research, this effort identified no incurable safety challenges, and found that most component degradation mechanisms are effectively managed by current plant programs. However, plant-specific challenges may exist, and several areas for further examination were identified. As with much of NRC’s aging research, these documents are generic rather than plant-specific.

## ■ External Review of Nuclear Power Plant Activities

Regular external review of nuclear utility power plant and corporate activities in the form of safety inspections and evaluations is fundamental to ensure safety for plants of all ages.<sup>61</sup> Outside inspections and evaluations of licensee performance are conducted by both the NRC and INPO. Some external review activities are closely related to concerns about plant aging. For example, reviews of utility maintenance practices can help ensure that those activities are performed adequately and will effectively identify degradation related to aging or other causes.

INPO evaluations of operating plants and corporate organizations involve in-depth team reviews conducted at an average interval of about 16 months.<sup>62</sup> The INPO evaluation reports are provided to the utility and are available to the NRC resident inspector but are not public documents. Subsequent INPO evaluations assess the

<sup>58</sup> U.S. Nuclear Regulatory Commission, *Annual Report 1991*, NUREG-1 145, vol. 8 (Washington, DC: July 1992), P. 161.

<sup>59</sup> W. Gunther and J. Taylor, Brookhaven National Laboratory, *Results from the Nuclear Plant Aging Research program: Their Use in Inspection Activities*, NUREG/CR-5507 (Washington, DC: U.S. Nuclear Regulatory Commission September 1990); and U.S. Nuclear Regulatory Commission, *Nuclear Plant Aging Research Program Plan*, NUREG-1 144, Rev. 2 (Washington, DC: June 1991), pp. 6.23-6.33.

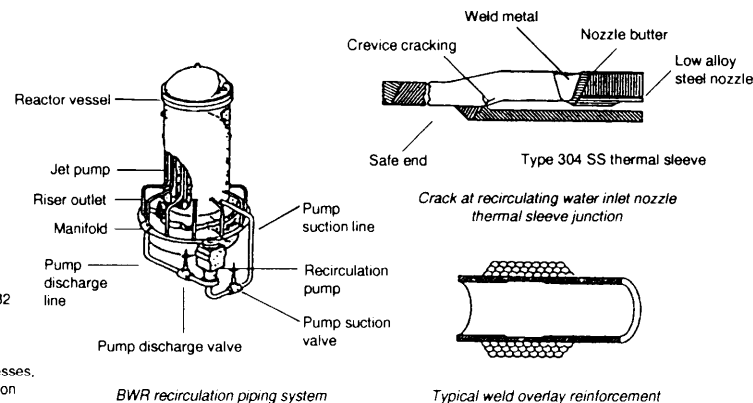
<sup>60</sup> Lawrence Shao, Director, Engineering Division, Office of Nuclear Regulatory Research, U.S. Nuclear Regulatory Commission, personal communication, February 1993.

<sup>61</sup> U.S. Nuclear Regulatory Commission, *Annual Report 1991*, NUREG-1 145, vol. 8 (Washington DC: July 1992), pp. 19-25.

<sup>62</sup> Institute of Nuclear Power Operations, “Institutional Plan for the Institute of Nuclear Power Operations,” Appendix A.

**Understanding and managing aging of BWR recirculation piping**

|                           |  |   |
|---------------------------|--|---|
| Materials                 | Piping   | Types 304, 316L, and 316NG SS   |
|                           | Fittings, pumps and valves   | Statistically cast SS - Gr. CF8 and CF8M  |
|                           | Safe ends  | Types 304, 316, 316NG SS and Alloy 600  |
|                           | Pipe-to-pipe and pipe-to-elbow welds   | Type 308L SS  |
|                           | Safe end-to-nozzle weld  | Weld material: 308L/308 SS or Alloy I-182/I-82<br>Nozzle butter: 308L SS Alloy I-182<br>Safe end butter: None Alloy I-182 |
| Stressors and environment | Operational transients, residual tensile stresses, applied stresses, oxygenated coolant, impurities in coolant, and contaminants on the outside surface. |   |



| UNDERSTANDING AGING<br>(materials, stressors, and environmental interaction)   |   |
|--|---|
| SITES  | AGING CONCERNS  |
| <ul style="list-style-type: none"> <li>Weld sensitized heat-affected zone.</li> <li>Furnace sensitized safe end, metallic and nonmetallic welds</li> <li>Types 304, 304L, 316, 316L SS).</li> </ul>                | <ul style="list-style-type: none"> <li>IGSCC                             <ul style="list-style-type: none"> <li>inside surface</li> <li>outside surface, if high residual tensile stresses (may be introduced, for example, by stress improvement) and contaminants are present.</li> </ul> </li> </ul> |
| <ul style="list-style-type: none"> <li>Sites with crevices and small amount of cold work</li> </ul>  | <ul style="list-style-type: none"> <li>IGSCC</li> </ul>   |
| <ul style="list-style-type: none"> <li>Sites with highly stressed regions and large amount of cold work</li> <li>Type 316NG SS).</li> </ul>  | <ul style="list-style-type: none"> <li>transgranular stress corrosion cracking (TGSCC).</li> </ul>  |
| <ul style="list-style-type: none"> <li>Sites subject to cyclic stresses.</li> </ul>  | <ul style="list-style-type: none"> <li>fatigue</li> </ul>   |
| <ul style="list-style-type: none"> <li>Duplex (austenitic-ferritic) stainless steels:                             <ul style="list-style-type: none"> <li>Fittings, pump and valve castings.</li> </ul> </li> </ul> | <ul style="list-style-type: none"> <li>Thermal embrittlement of high delta ferrite (greater than 10 percent ferrite) regions, IGSCC of low delta ferrite (less than 10 percent ferrite) regions.</li> </ul>   |

| MANAGING AGING   |   |
|--|---|
| SERVICE INSPECTION, SURVEILLANCE & MONITORING  | MITIGATION  |
| <p><b>NRC requirements</b></p> <ul style="list-style-type: none"> <li>Ultrasonic inspection of weldments as per NRC Generic Letter 88-01.</li> <li>Reduced inspection period and increased sample size for piping made of non-IGSCC resistant materials (e.g., Type 304 SS):                             <ul style="list-style-type: none"> <li>for weldments without cracks, depends on when stress improvement implemented;</li> <li>for weldments with cracks, depends on whether cracks have been reinforced by weld overlay or mitigated by stress improvement;</li> <li>inspection procedure for weld overlay repair to detect cracks that were 75 percent of the original wall thickness;</li> <li>inspection period can be as short as one refueling cycle, and sample size can be as large as all welds.</li> </ul> </li> </ul> | <p><b>Recommendations</b></p> <ul style="list-style-type: none"> <li>Develop improved methods to inspect weld overlay repairs.</li> <li>For leak detection:                             <ul style="list-style-type: none"> <li>install moisture sensitive tape on susceptible region of piping</li> <li>use acoustic emission monitoring method.</li> </ul> </li> <li>Conduct online monitoring of coolant chemistry.</li> <li>For effective hydrogen water chemistry control:                             <ul style="list-style-type: none"> <li>maintain electrochemical corrosion potential on standard hydrogen electrode scale to less than or equal to -230 mV</li> <li>maintain coolant conductivity less than or equal to <math>\mu\text{S/cm}</math>.</li> </ul> </li> </ul> |
|  | <ul style="list-style-type: none"> <li>Employ weld overlay, mechanical stress improvement, reduction heating stress improvement, and clamping device for repairing welded piping.</li> <li>Use Type 316NG SS corrosion-resistant cladding, solution heat treatment, and heat sink welding or replacement piping.</li> <li>Evaluate the use of 347 NG SS as piping material.</li> <li>Assess the effects of hydrogen water chemistry on overall plant operation:                             <ul style="list-style-type: none"> <li>radiation fields;</li> <li>fuel performance; and</li> <li>acceptable length and frequency of short outages if hydrogen water chemistry.</li> </ul> </li> </ul>   |

**Figure 2-3-Nuclear Plant Aging Research Program Summary of Boiling Water Reactor Recirculation Piping Aging Issues**

SOURCE: U.S. Nuclear Regulatory Commission, *Nuclear Plant Aging Research (NPAR) Program Plan*, NUREG-1 144, Rev. 2, June 1991, p. 632.

### Box 2-E—The Nuclear Regulatory Commission's Nuclear Plant Aging Research Program

Under the U.S. Nuclear Regulatory Commission's (NRC's) Nuclear Plant Aging Research (NPAR) Program, aging assessments have been or are being performed on over 40 categories of systems, structures, and components (**SSCs**) considered significant to safety, many of which are relatively short-lived.<sup>1</sup> These SSCs *were* selected based on their significance to plant safety, operating experience, expert opinion, and susceptibility to aging degradation, not necessarily whether they are short- or long-lived.

A one- or two-phase examination is performed for each SSC. Phase I involves a paper examination, including review of the design, materials, and operating stresses and a survey of operating experiences and historical failures for the selected SSC. Also, the existing SSC inspection and monitoring methods are examined to determine their effectiveness in detecting aging degradation before failure occurs. Often, the adequacy of artificial or accelerated aging techniques used to qualify the SSC for its design lifetime are compared to available data from their naturally aged counterparts. The result of a Phase I evaluation is an interim assessment of probable failure modes.

Phase-II NPAR assessments, which the NRC may deem unnecessary depending on Phase I results, may involve laboratory tests of naturally or artificially aged equipment; aging assessments by experts; recommendations for inspection or monitoring techniques; and in-situ examinations. As shown in the tables, analyses have been performed for many SSCs, but several have yet to be initiated.

Because of substantial variations in hardware and procedures at U.S. operating nuclear plants, the NRC examinations are not intended as in-depth engineering evaluations of all significant SSCs. That responsibility ultimately belongs to the operators of each nuclear plant. This is particularly the case with major components and structures **such as pressure vessels, emergency diesel generators (EDGs), or primary containment**, for which laboratory examinations are infeasible.

For example, nuclear power plant EDGs are large and complex, with about 25 models supplied by nine vendors in current use. Because naturally aged EDGs on which to perform indepth laboratory examinations are not available, the NPAR program approach is to use expert opinion drawn from national laboratories, consultants, manufacturers, and utilities to examine historical failures and to identify the components most vulnerable to aging and identify mitigation measures.

<sup>1</sup> Structural and materials aging research are conducted under separate programs at the NRC.

<sup>2</sup> K.R. Hoopingarner and F.R. Zaloudek, Pacific Northwest Laboratory, *Aging Mitigation and Improved Programs for Nuclear Service Diesel Generators* NUREG/CR-5057 (Washington, DC: U.S. Nuclear Regulatory Commission, March 1989).

Table 2-I-Systems and Components in the Nuclear Plant Aging Research Program and Their Completion Schedule

| Topic   | Laboratory | Schedule                                 |
|---|------------|--|
| <i>Components</i>                                       |            |  |
| Motor-operated valves                                   | ORNL       | Complete in fiscal year 1991             |
| Check valves  | ORNL       | Complete in fiscal year 1991             |
| Solenoid valves   | ORNL       | Complete in fiscal year 1991             |
| Air-operated valves                                     | ORNL       | initiate Phase 1 in fiscal year 1991     |
| Auxiliary feedwater pumps                               | ORNL       | Complete in fiscal year 1991             |
| Small electric motors                                   | ORNL       | Completed in fiscal year 1988            |
| Large electric motors                                   | BNL        | Initiate phase 1 in fiscal year 1992     |
| Chargers/inverters                                      | BNL        | Completed in fiscal year 1990            |
| Batteries   | INEL       | Completed in fiscal year 1990            |
| Power-operated relief valves                            | ORNL       | Completed In fiscal year 1989            |
| Snubbers  | PNL        | Complete phase 2 in fiscal year 1991     |
| Circuit breakers/relays                                 | BNL, Wyle  | Complete phase 2 in fiscal year 1991     |
| Electrical penetrations                                 | SNL        | Complete phase 1 in fiscal year 1991     |
| Connectors, terminal blocks                             | SNL        | Initiate phase 1 in fiscal year 1991     |
| Chillers  | PNL        | Initiate phase 1 in fiscal year 1991     |
| Cables  | SNL        | Complete phase 2 in fiscal year 1991     |
| Diesel generators                                       | PNL        | Phase 2 completed in fiscal year 1989    |
| Transformers  | INEL       | Complete phase 1 in fiscal year 1991     |
| Heat exchangers   | ORNL       | Complete phase 1 in fiscal year 1991     |
| Compressors   | ORNL       | Phase 1 completed in fiscal year 1990    |
| Bistables/switches                                      | BNL        | Initiate phase 1 in fiscal year 1991     |
| Main steam isolation valves                             | ORNL       | Initiate phase 1 in fiscal year 1991     |
| Accumulators  |            | No initiative                            |
| Surge arrestors   |            | No initiative                            |
| Isolation condensers (BWR)                              |            | No initiative                            |
| Purge and vent valves                                   |            | No initiative                            |
| Safety relief valves                                    |            | No initiative                            |
| Service water and component cooling water pumps         |            | No initiative                            |
| <i>Systems</i>  |            |  |
| High-pressure emergency core cooling system             | INEL       | Complete phase 1 in fiscal year 1991     |
| RHR/Low-pressure emergency core cooling system          | BNL        | Complete phase 2 in fiscal year 1991     |
| Service water   | PNL        | Phase 2 completed in fiscal year 1990    |
| Component cooling water                                 | BNL        | Complete phase 2 in fiscal year 1992     |
| Reactor protection                                      | INEL       | Complete phase 2 in fiscal year 1991     |
| Class 1 E electric distribution                         | INEL       | Complete phase 2 in fiscal year 1991     |
| Auxiliary feed water                                    | ORNL       | initiate phase 1 in fiscal year 1991     |
| Control rod drive, PWR (W)                              | BNL        | Phase 1 completed in fiscal year 1990    |
| Control rod drive, PWR (B&W, CE)                        | BNL        | Complete phase 1 in fiscal year 1991     |
| Control rod drive, BWR                                  | ORNL       | Complete phase 1 in fiscal year 1991     |
| Motor control centers                                   | BNL        | Completed in fiscal year 1989            |
| instrument air  | BNL        | Complete phase 2 in fiscal year 1992     |
| Containment cooling                                     | BNL        | Complete phase 1 in fiscal year 1991     |
| Engineered safety features                              | PNL        | Initiate phase 1 in fiscal year 1991     |
| instrument and control                                  | ORNL       | Complete phase 1 in fiscal year 1992     |
| Automatic depressurization (BWR)                        | PNL        | Complete pre-phase 1 in fiscal year 1991 |
| Standby liquid control (BWR)                            | PNL        | Complete phase 1 in fiscal year 1991     |
| Core internals  | ORNL       | initiate phase 1 in fiscal year 1991     |
| Turbine main generator and controls                     | ORNL       | initiate phase 1 in 1991                 |
| Containment isolation                                   |            | No initiative                            |
| Recirculation pump trip actuation instrumentation (BWR) |            | No initiative                            |
| Reactor core isolation cooling                          |            | No initiative                            |

SOURCE: U.S. Nuclear Regulatory Commission, *Nuclear Plant Aging Research (NPAR) Program Plan*, NUREG-1144, Rev. 2 (Washington, DC: June 1991).



effectiveness of utility actions to address previously identified items.

The NRC inspection program is intended to evaluate plant compliance with the current licensing basis (CLB) (box 2-F), to determine reactor safety, and to identify conditions that may warrant corrective actions. The inspection staff also collects information used in the NRC Systematic Assessment of Licensee Performance (SALP) evaluations (box 2-G). Each operating plant has at least one full-time, onsite NRC resident inspector. The resident inspectors directly observe and verify licensee activities in the control room, in maintenance and surveillance testing, and in the configuration of equipment important to safety, and they conduct frequent general plant tours. In addition to the regular duties of resident inspectors, inspectors from the five NRC regional offices and the NRC headquarters periodically perform a variety of more detailed technical inspections.

NRC team inspections are conducted by technical specialists drawn from both the NRC and its contractor organizations (e.g., the national laboratories). These specialists spend several weeks at a plant investigating a specific topic, such as maintenance, emergency operations, or the testing of motor-operated valves. Maintenance Team Inspections in which all maintenance-related plant activities were observed in detail were conducted at all plants in the late 1980s and early 1990s. These inspections found adequate programs and implementation at all sites. These favorable findings partially explain why the NRC promulgated a relatively flexible maintenance rule in 1991.<sup>63</sup>

<sup>63</sup> 56 *Federal Register* 31321 (July 10, 1991).

<sup>64</sup> License terms were initially set based on the start of plant construction rather than the start of operation. However, the NRC has established a relatively simple administrative procedure to recover the construction period and thereby extend the expiration date of the initial operating licenses without renewal. Memorandum from W.J. Dircks, Executive Director for Operations to the Commissioners, U.S. Nuclear Regulatory Commission, Aug. 16, 1982. To date, over fifty such extensions have been granted. 58 *Federal Register* 7899. Feb. 10, 1993.

<sup>65</sup> U.S. Nuclear Regulatory Commission, Implementation of 10 CFR Part 54, "Requirements for Renewal of Operating Licenses for Nuclear Power Plants," SECY-93-049, Mar. 1, 1993.

**Table 2-2-Completed Nuclear Plant Aging Research Life Assessments for Major Components**

---

|  |
|--|
| Emergency diesel generators  |
| Pressurized Water Reactor (BWR) and Boiling Water Reactor (BWR) pressure vessels |
| BWR Mark I containments  |
| PWR and BWR pressure vessel Internals  |
| PWR cooling system piping and nozzles  |
| PWR steam generator tubes  |
| Pressurizer, surge and spray lines   |
| BWR recirculation piping   |
| LWR coolant pumps  |

---

SOURCE: U.S. Nuclear Regulatory Commission, *Nuclear Plant Aging Research (NPAR) Program Plan*, NUREG-1 144, Rev. 2. (Washington, DC: June 1991).

## License Expiration and Renewal for Aging Management

The AEA specifies that commercial nuclear plant operating licenses may not exceed 40 years but may be renewed upon expiration.<sup>64</sup> The fixed term was established in the AEA for financial and other nontechnical reasons, although once chosen, it became an assumption in specifying certain plant design features (e.g., the number of thermal cycles occurring, and thus the requirements for addressing fatigue).

NRC license renewal requirements center on the management of aging degradation. As a result of its license renewal work, the NRC staff identified fatigue and environmental qualification of electrical equipment (EQ) as possible generic safety issues to be examined for all plants during their current license terms.<sup>65</sup> The importance of fatigue and EQ to aging is well known to both the commercial nuclear power industry and the NRC, and considerable attention has been directed to these issues (box 2-H). Rather than identifying new aging issues, examining these

### Box 2-F-Current Licensing Bases

A plant's current licensing basis (CLB) includes all NRC requirements, whether made during initial licensing or as modified over time.<sup>1</sup> This large body of requirements is contained in a variety of documents, including:

- a plant's operating license application or Safety Analysis Report;
- plant-specific compliance with NRC regulations noted in 10 CFR Part 50, as well as other parts of Title 10 of the Code of Federal Regulations;
- NRC orders, license conditions, exemptions, and technical specifications; and
- all written commitments made by the licensee in docketed responses to NRC bulletins and generic letters.<sup>2</sup>

NRC regulations and industry practices draw on the codes and standards of many organizations such as the American Society of Mechanical Engineers, the Institute for Electrical and electronics Engineers, the American Society of Civil Engineers, and American Society of Testing and Materials.

The CLB for each plant is unique. Differences result from variations in plant siting (e.g., a plant located near an active fault requires special seismic protection features); plant design (e.g., whether a boiling or pressurized water reactor, the number of steam generators); different regulations and regulatory interpretations in effect at the time of licensing; and plant operating experience (e.g., special problems leading to additional commitments to the NRC). Many NRC requirements, such as the maintenance rule, explicitly address aging safety issues.

<sup>1</sup> For additional discussion of the NRC's views of current licensing bases, see U.S. Nuclear Regulatory Commission, *Foundation for the Adequacy of the Licensing Bases*, NUREG-1412 (Washington, DC: December 1991).

<sup>2</sup> In its effort to provide the commercial nuclear power industry information on operating experience, each year the NRC issues about 5 generic bulletins, about 20 generic letters, and about 100 information notices. Science Applications International Corporation, *Generic Communications Index*, NUREG/CR-4690 (Washington, DC: U.S. Nuclear Regulatory Commission, May 1991). Although the informal guidance does not carry the same legal authority as regulations, licensees are often motivated to address the issues raised. Their docketed responses to the generic communications then become part of the plant's formal requirements.

topics as generic safety issues provides a method for identifying and prioritizing issues based on potential safety significance and implementation costs.<sup>66</sup>

The NRC license renewal rule is founded on two key principles:

1. With the exception of age-related degradation unique to license renewal (ARDUTLR), and possibly some few other issues related to safety only during extended operation, the existing regulatory process is adequate to ensure that the licensing bases of all currently operating plants provide and maintain an acceptable level of safety; and

2. each plant's CLB must be maintained during the renewal period, in part through a program of aging degradation management for SSCs that are important to license renewal.<sup>67</sup>

If approved, the renewed License would supersede the existing license, with the requested extension period increased to reflect the time remaining under the current license.

In any event, the duration of the renewal license would be limited to 40 years, including an extension of no more than 20 years. The NRC has estimated that the effort required by a utility to submit a license renewal application would re-

<sup>66</sup> U.S. Nuclear Regulatory Commission, *A Prioritization of Generic Safety Issues*, NUREG-0933, semi-mud report series.

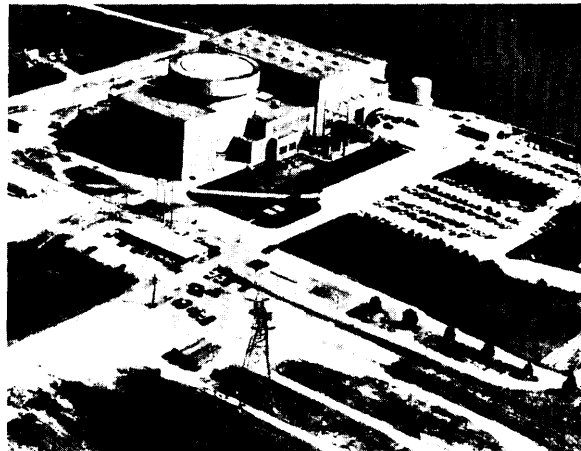
<sup>67</sup> 56 *Federal Register* 64943 et seq. (Dec. 13, 1991).

quire approximately 200 person-years of utility effort (supplemented by unquantified consultant support) and span 3 to 5 calendar years at a cost of about \$30 million.<sup>68</sup>

Under the license renewal rule, an applicant must perform an integrated plant assessment (IPA), analyzing all mechanisms that result in age degradation, even for short-lived SSCs that are routinely replaced. For degradation identified as ARDUTLR, the utility must demonstrate a program to monitor or control that degradation. This plant-specific assessment is intended to guide the licensee through a structured process in order to demonstrate that aging degradation of plant SSCs has been identified, evaluated, and addressed, and to ensure that the licensing basis will be maintained throughout the renewed license term.

As discussed in detail in chapter one, there are some practical problems with implementing the rule and its accompanying statement of considerations (SOC). These involve such issues as the level of detail required in the IPA, problems with key definitions (e.g., ARDUTLR as defined has little practical meaning), and consistency with other aging management requirements (e.g., the maintenance rule). As discussed in chapter one, the NRC is considering revising the rule or specifying a simplified implementation process.<sup>69</sup>

No plant has yet submitted a license renewal application. Owners of the Yankee Rowe and the Monticello plants originally planned to submit license renewal applications in 1991 as part of a jointly funded, multiyear DOE/industry lead-plant program. However, poor economics, including the costs of answering questions about the safety of their RPV, prompted Yankee Rowe's owners to opt for early retirement in late 1991. In late 1992, Monticello's owner indefinitely de-



U.S. NUCLEAR REGULATORY COMMISSION

*The operating license for the Fort Calhoun Station expires in 2008. Recapture of the construction period could allow 5 years additional operation before license renewal would be required.*

ferred its renewal application, citing concern about the interpretation of NRC's rule, noting that the number of systems to be reviewed had grown from the original 74 to 104 with "no indication of where it might go from there."<sup>70</sup> Also noted were concern over operational cost increases and about DOE's ability to accept spent fuel. Finally, in late 1992, the Babcock and Wilcox Owners' Group announced its intentions to pursue a joint effort in developing a license renewal application. Other owners' groups are pursuing similar efforts.

License renewal has implications for other NRC safety requirements for specific plants. One example is application of the backfitting rule.<sup>71</sup> Although a plant's CLB is supposed to be adequate for protecting the public health and safety, the backfitting rule allows additional requirements when certain conditions are met. Specifically, the rule allows such additional requirements if a backfit analysis shows that there

<sup>68</sup> U.S. Nuclear Regulatory Commission, *Regulatory Analysis for Final Rule on Nuclear Power Plant License Renewal*, NUREG-1362 (Washington, DC: October 1991), table 4.6.

<sup>69</sup> U.S. Nuclear Regulatory Commission, *SKY-93-1 13*, Apr. 30, 1993; and U.S. Nuclear Regulatory Commission, *SECY-93-049*, Mar. 1, 1993.

<sup>70</sup> Jim Howard, Chief Executive Officer of Northern States power cited in *Nucleonics Week*, vol 133, No. 46, Nov. 12, 1992, pp. 12, 13.

<sup>71</sup> 10 CFR 50.109.

### Box 2-G--Systematic Assessment of Licensee Performance and Other Performance Indicators

The Systematic Assessment of Licensee Performance (SALP) program is an integrated effort to assess how well a given licensee directs and provides the resources necessary to provide the requisite assurance of safety. The purpose of these NRC assessments is to direct better both the NRC and licensee attention and resources at a facility to those safety issues requiring the most attention. Some in the nuclear industry, however, have suggested that the SALP process is subjective and not factually supported.<sup>1</sup>

The SALP assessment includes reviews of licensee event reports (LERs), inspection reports, enforcement history, and licensing issues. These ratings are a subjective summary of the performance of the licensee in each functional area. New data are not necessarily generated in the conduct of a SALP assessment. The SALP assessment rates performance in selected functional areas: plant operations, radiological controls, maintenance and surveillance, emergency preparedness, security, engineering and technical support, and safety assessment and quality verification. SALP rating categories are the following:

- 1: This rating designates a superior level of performance where reduced NRC attention may be appropriate.
  - 2: This rating designates a good level of performance where NRC attention should be maintained at normal levels.
  - 3: This rating designates an acceptable level of performance where the NRC will consider increased levels of inspection.
- N: insufficient information exists to support an assessment of licensee performance.

NOTE: There is no failing grade, but plants not meeting acceptable levels (i.e., inadequate performance to receive a category 3 rating) are issued a "show cause" order resulting in their shutdown.

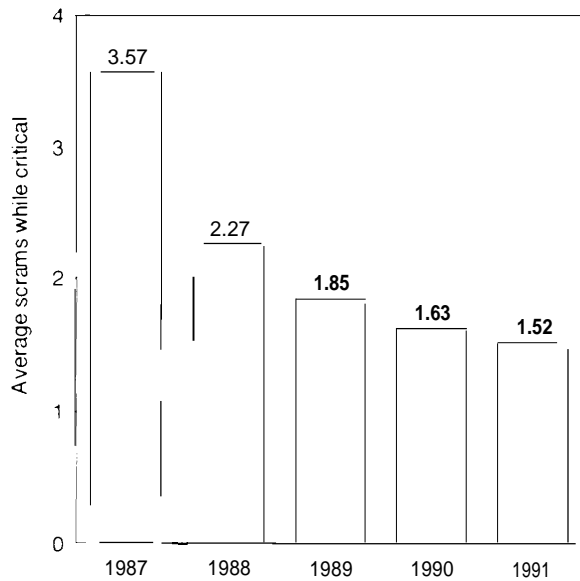
Since 1986 the NRC has also provided quantitative indicators of nuclear power plant safety performance. The program currently provides seven performance indicators, including the average number of SCRAMS and the equipment forced outage rate (see figures 2-4 and 2-5). These data are published and provided to NRC senior managers on a quarterly basis, and each utility receives the reports for its plants. In contrast with the NRC SALP program, which provides subjective evaluations of licensee performance, the performance indicators measure well-defined, discrete events. However, the relationship between these indicators and expected public health and safety impacts, while giving a sense of safety performance, is not definitive.

The Institute of Nuclear Power Operations (INPO) has also developed quantitative indicators of nuclear performance. The INPO program includes such factors as plant capability factor, rate of unplanned automatic scrams, collective radiation exposure, and industrial accident rates. In addition to publishing the indicators for industry-wide performance, INPO has set goals for improving future performance that are intended to be challenging but achievable.<sup>2</sup>

<sup>1</sup>U.S. Nuclear Regulatory Commission, *Industry Perceptions of the Impact of the U.S. Nuclear Regulatory Commission on Nuclear Power Plant Activities*, NUREG 1395 draft (Washington, DC: March 1990), p. 13.

<sup>2</sup>Institute of Nuclear Power Operations, "1992 Performance Indicators for the U.S. Nuclear Industry," (Atlanta, GA: March 1993).

**Figure 2-4—Average Number of Reactor Scrams While Critical**



SOURCE: U.S. Nuclear Regulatory Commission, 1991 *Annual Report*, NUREG-1145, vol. 8 (Washington, DC: July 1992), p. 52.

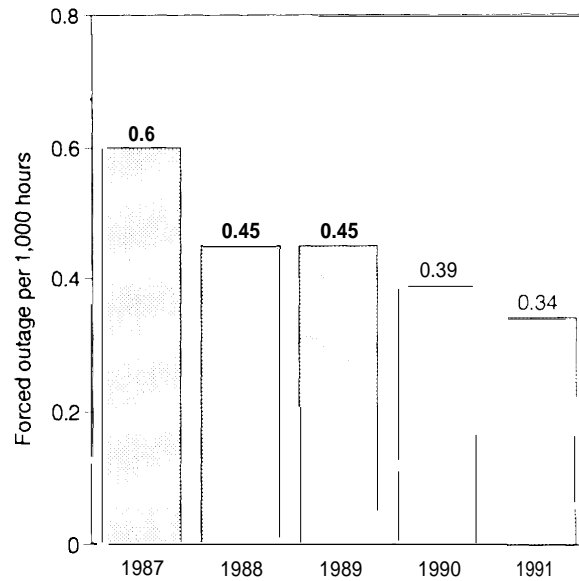
will be a substantial increase (beyond *adequate* protection) in the overall protection of the public health and safety and if the implementation costs warrant this increased protection. Because license renewal extends a plant operating life, the safety benefits estimated in the backfit analysis will generally be greater than under the original license term. The extent to which potentially costly backfits will be required as a condition of license renewal has not been determined.

## HEALTH AND SAFETY GOALS FOR AGING PLANTS

### ■ Public Health and Safety Goals for Nuclear Power Plants

To address the issue of acceptable public safety risks from operating nuclear power plants, the NRC set formal, qualitative safety goals for plant operations in 1986 after several years of develop-

**Figure 2-5—Average Equipment Forced Outage Rate Per 1,000 Critical Hours**



SOURCE: U.S. Nuclear Regulatory Commission, 1991 *Annual Report*, NUREG-1145, vol. 8 (Washington, DC: July 1992), p. 52.

ment.<sup>72</sup> The goals established by the NRC for public and occupational health and safety for existing plants do not change as the plants age. The goals, which apply to existing as well as future plants, are:

- Individual members of the public should be provided a level of protection from the consequences of nuclear power plant operation such that individuals bear no significant additional risk to life and health.
- Societal risks to life and health from nuclear power plant operation should be comparable to or less than the risks of generating electricity by viable competing technologies and should not be a significant addition to other societal risks.

The NRC also set the following quantitative objectives for risk of immediate deaths caused by a radiological accident and for deaths from cancer to be used in determining achievement of the goals:

<sup>72</sup> 51 *Federal Register* 30028 *et seq.* (Aug. 21, 1986).

### Box 2-H--Environmental Qualification of Electrical Equipment

A wide variety of electrical cables from different manufacturers are used in nuclear power plants for instrumentation and controls. Cables used in fossil-fuel power plants have generally performed well for as much as 60 years, even though the materials used were inferior & newer cables.<sup>1</sup> Cables used in nuclear plants have a similar excellent operating history. However, aging degradation resulting from high temperature and radiation may go undetected and result in inadequate performance under the additional environmental stresses of accident conditions. Cables required to **perform a safety function during and following a design basis event are required to qualified** considering the effects of aging.<sup>2</sup>

Institute of Electrical and Electronics Engineers (IEEE) standards adopted in 1974 and incorporated in NRC requirements specify an environmental qualification (EQ) procedure involving accelerated aging of test samples to ensure that aged cables perform adequately under accident conditions.<sup>3</sup> However, EQ testing of pre-aged samples **was not required for the more than 50 plants receiving construction permits before June 1974, although consideration of aging effects were to be considered in design. Cable testing and surveillance within a plant's containment is minimal, because they are often hard to access.**

The NRC conducts an extensive, ongoing cable testing program at Sandia **National Laboratories, which examines a wide variety of cables.**<sup>4</sup> The results generally indicate that most popular cable types should perform adequately during current plant operating license and any renewed terms, although there maybe some exceptions requiring further **analyses?** Similarly, EPRI initiated a multiyear project in 1985 to compare natural and artificial aging for a limited number of cable types.<sup>5</sup> Initial results have found no changes in material properties of concern.

Overall, electrical equipment performance has been excellent, research results on cable aging have been favorable, and EQ has not raised near-term concerns for plant operation, but both the NRC and the commercial nuclear power industry continue to address some longer term issues. NRC staff, for example, recently proposed re-examining the adequacy of current EQ requirements as a generic safety issue.<sup>7</sup> Among the issues that may have long-term impacts are the following:

- the accuracy of EQ methods involving artificial aging,
- the appropriateness of **current EQ requirements for cables for which artificial aging tests were not required, and**
- a lack of effective testing and surveillance methods to detect degradation.

<sup>1</sup> A.S. Amar, et al., *Residual Life Assessment of Major Light Water Reactor Components—Overview*, NUREG/CR-4731 (Washington, DC: U.S. Nuclear Regulatory Commission, November 1989).  
210 CFR 5049.

<sup>3</sup> IEEE 383-1974; incorporated in 10 CFR 50.49.

<sup>4</sup> Sandia National Laboratories, *Aging, Condition Monitoring, and Loss of Coolant Accident Tests of Class 1E Electrical Cables*, NUREG CR-5772, vol. 1-3 (Washington, DC: Nuclear Regulatory Commission, 1992).

<sup>5</sup> For example, Sandia tests recently identified a potential deficiency for one specific brand of cable when used according to its environmental qualification. A. Thadani, U.S. Nuclear Regulatory Commission, Memorandum to Steven Varga, Director, NRC Division of Reactor Projects, Jan. 27, 1993.

<sup>6</sup> University of Connecticut, *Natural Versus Artificial Aging of Nuclear Power Plant Components*, EPRI TR-100245 (Palo Alto, CA: Electric Power Research Institute, January 1992).

<sup>7</sup> U.S. Nuclear Regulatory Commission, SECY 93-049, Mar. 1, 1993.

- The risk to an average individual in the vicinity of a nuclear power plant of prompt fatalities that might result from reactor accidents should not exceed one-tenth of one percent (0.1 percent) of the sum of prompt fatality risks resulting from other accidents to which members of the U.S. population are generally exposed.
- The risk to the population in the area near a nuclear power plant of cancer fatalities that might result from nuclear power plant operation should not exceed one-tenth of one percent (0.1 percent) of the sum of cancer fatality risks resulting from all other causes,

These goals provide useful guidance in evaluating the adequacy of plant safety and in developing and implementing regulatory requirements. There remain, however, some limitations to the safety goal policy as it relates to plant aging and to existing plants generally. Limitations to the safety goal policy include the practical translation of risk-based goals into regulatory activities, no consideration of changing population characteristics near a plant, no discussion of the cost-benefit analyses now used in safety decisions, and an unclear relationship and consistency with safety goals found in other Federal law.

Perhaps the greatest weakness of the safety goal policy is the practical difficulty of translating the risk-based goals into regulatory practices. The relationship between many of NRC's regulatory activities and its safety goals is unclear. For example, the safety goal policy is not mentioned in the license renewal rule, the 32-page Statement

of Considerations accompanying the rule,<sup>73</sup> or the NRC's regulatory analysis of the rule.<sup>74</sup> Similarly, the most recent plan for the NRC Nuclear Plant Aging Research (NPAR) program does not reference the safety goal policy in any of its approximately 170 pages.<sup>75</sup> One aging-related example of a regulatory effort explicitly incorporating risk issues is the maintenance rule, which requires consideration of risk-significance in the development of maintenance programs.<sup>76</sup> The NRC has an ongoing effort to make greater application of the safety goal policy.<sup>77</sup>

A second limitation with the safety goal policy is indirectly related to plant age: the changing population characteristics over the life of a plant are not addressed. When the safety goal was first adopted, one NRC Commissioner noted that the safety goals do not explicitly include population density considerations; a power plant could be located in Central Park and still meet the standard.<sup>78</sup> Population density and other related demographic characteristics (e.g., transportation facilities) can all change over the decades a plant is in operation.

Regarding the use of cost-benefit analyses, the backfit rule allows the NRC to require safety efforts that surpass those necessary for the adequate protection of public health and safety.<sup>79</sup> These safety efforts must meet an economic test, comparing costs with the expected benefits of improved safety. This suggests a third limitation with the safety goal policy, because it does not address the appropriateness of mandating activities not necessary for adequate protection, or the

<sup>73</sup> 56 *Federal Register* 64943-64980 (Dec. 13, 1991).

<sup>74</sup> U.S. Nuclear Regulatory Commission *Regulatory Analysis for Final Rule on Nuclear Power Plant License Renewal*, NUREG-1362 (Washington, DC: October 1991).

<sup>75</sup> U.S. Nuclear Regulatory Commission, *Nuclear Plant Aging Research (NPAR) Program Plan*, NUREG-1144, Rev. 2 (Washington, DC: June 1991).

<sup>76</sup> 10 CFR 50.65(a)(3).

<sup>77</sup> U.S. Nuclear Regulatory Commission "Interim Guidance on Staff Implementation of the Commission's Safety Goal Policy," SECY-91-270.

<sup>78</sup> 51 *Federal Register* 30033 (Aug. 21, 1986).

<sup>79</sup> 10 CFR 50.109.

role of economic analyses in supporting those requirements. This can be an important license renewal issue, as the extended operating period results in higher estimated benefits. Specifically, license renewal may result in additional costs for NRC-mandated backfits not required for adequate safety.

A fourth limitation with the safety goal policy is unrelated to plant aging but relevant to determining the adequacy of the goals: indications of consistency with safety goals found in other Federal law. Nuclear power plants are not unique among electricity supplies in imposing public health and safety risks. Production and use of fossil fuels contribute to health problems ranging from respiratory disease related to particulate and sulfur oxides, to cancers associated with carcinogenic releases from petrochemical facilities, to fatal accidents in the mining and transportation of coal.<sup>80</sup> Heavy use of fossil fuels also produces substantial CO<sub>2</sub> emissions, which contribute to the chance of potentially catastrophic public health and safety impacts resulting from global environmental change. Even energy efficiency measures can create public health and safety risks. For example, better sealed houses can result in indoor air quality problems, such as increased radon exposures. Although the NRC safety goal suggests comparing nuclear plant risks to the risks of other generating sources, a belief that “the absence of authoritative data make it impractical to calibrate nuclear safety goals by comparing them with coal’s risks based

on what we know today,” led the NRC to omit quantitative objectives for explicitly assessing that portion of the goal.<sup>81</sup>

### ■ The Impact of Aging on the Attainment of Safety Goals

The best available evidence indicates that NRC’s public safety goals are met with wide margins, and should continue to be met as plants age, assuming effectively designed and implemented maintenance programs and continuing research to identify latent aging effects. There will always remain some risk and uncertainties, however, and continued nuclear industry and Federal regulatory vigilance remains crucial to implement current practices and to revise them as necessary.

Regardless of plant aging effects, the public cancer risk from normal nuclear plant operation appears very low relative to the NRC goal. Aging management activities, such as equipment replacement and other maintenance work, are primarily contained within a plant.<sup>82</sup> According to the NRC, these activities are unlikely to alter the offsite radiation exposures currently experienced.<sup>83</sup> The estimated public radiation doses from nuclear power plants are extremely low—very far below the allowed maximum.<sup>84</sup> In part, estimated public doses are far below regulatory ceilings, because of an additional regulatory requirement to limit exposures to “as low as is reasonably achievable” (ALARA).<sup>85</sup>

In 1988, the estimated average annual dose for a member of the public residing near a nuclear

<sup>80</sup> U.S. Environmental Protection Agency, Office of Air and Radiation, “Regulatory Impact Analysis on the National Ambient Air Quality Standards for Sulfur Oxides (Sulfur Dioxide),” draft, May 1987, chapters 6 and 7.

<sup>81</sup> 51 *Federal Register* 30030 (Aug. 21, 1986).

<sup>82</sup> Every nuclear plant releases some radionuclides during normal operations to which the public may be exposed. (Some coal Power plants also release some radionuclides, depending on impurities in the coal.)

<sup>83</sup> U.S. Nuclear Regulatory Commission, *Environmental Assessment for Final Rule on Nuclear Power Plant License Renewal*, NUREG-1398 (Washington DC: October 1991), p. iii.

<sup>84</sup> Beginning in 1994, the maximum annual exposure limit for a member of the public living near a nuclear plant is lowered from 500 to 100 mrem, still thousands of times higher than estimated maximum exposures. 10 CFR 20.1301(a).

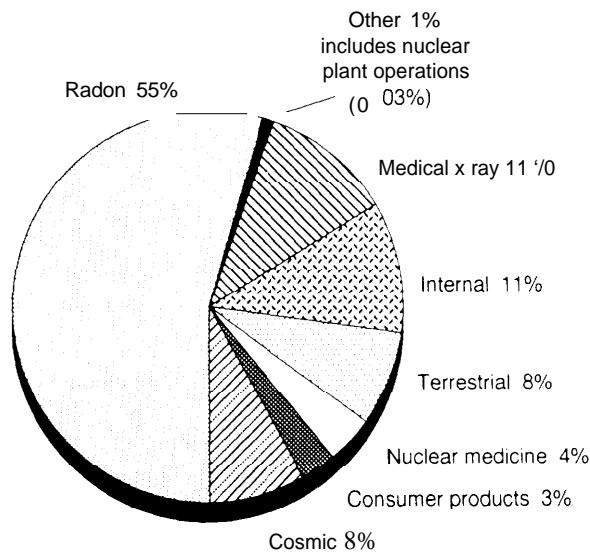
<sup>85</sup> ALARA involves “taking into account the state of technology, and the economics of improvements in relation to benefits to the public health and safety, and other societal and socioeconomic considerations, and in relation to the utilization of atomic energy in the public interest.” 10 CFR 20.1(c).



plant was about 0.001 mrem.<sup>86</sup> This dose represents a very small fraction of the total exposure from all sources, including natural ones such as cosmic rays or radon-bearing granite (figure 2-6). The best available evidence indicates that the excess cancer risk to the public from operating nuclear power plants is less than 0.00003 percent, over three orders of magnitude below the safety goal of 0.1 percent additional cancer mortality risk.<sup>87</sup> There are uncertainties in estimating health impacts for any level of radiation exposure (box 2-1). If, however, future exposures and risk remain even remotely similar to past experience, the safety goal should be readily met.

With regard to accident risks, the best available information, although inherently uncertain, indicates that if aging is properly managed the risk of fatalities resulting from a severe nuclear power plant accident in the United States is low relative to the NRC safety objective. For example, the NRC's best and most detailed estimates indicate that an individual near a nuclear plant faces a risk from a plant accident of less than 0.02 per million (figure 2-7).<sup>88</sup> In contrast, the accidental death rate in 1990 from non-nuclear accidents for the U.S. population was about 370 per million people, or over 18,000 times higher.<sup>89</sup> Thus, the NRC's safety objective for prompt fatality risk appears met by at least a factor of about 18.

Figure 2-6—Average Annual Background Radiation Exposure, U.S. Population (360 millirems)



SOURCE: National Research Council, *Health Effects of Exposure to Low Levels of Ionizing Radiation BEIR V* (Washington, DC: National Academy Press, 1990), p. 19.

For context, consider the accidents at Three Mile Island (TMI) in 1979 and at Chernobyl in 1986, neither of which was related to power plant aging. At TMI, there were no immediate fatalities, and the best estimate of resulting cancer fatalities over the next several decades is zero.<sup>90</sup> Despite a partial core meltdown, there was no containment

<sup>86</sup> The estimated *maximum* annual dose received by any member of the public in 1988 was 0.02 mrem. D.A. Baker, Pacific Northwest Laboratory, *Population Dose Commitments Due to Radioactive Releases from Nuclear Power Plant Sites in 1988*, NUREG/CR-2850, vol. 10 (Washington DC: U.S. Nuclear Regulatory Commission January 1992), pp. iii, 1.4-1.5. 1988 is the most recent year for which estimated exposures were readily available from the NRC. Radiation monitoring systems at various locations within and around each plant are used, but radiation levels beyond plant boundaries are often too low to register sufficient information about the exposure of neighboring populations. Therefore, annual exposures for neighboring populations within 50 miles of power plants are estimated based on known releases. Tom Essig, Office of Nuclear Reactor Regulation, U.S. Nuclear Regulatory Commission, personal communication Feb. 18, 1993.

<sup>87</sup> For an annual lifetime dose of 100 mrem, the best estimate of excess cancer mortality is about 3 percent. Committee on the Biological Effects of Ionizing Radiations, National Research Council, *Health Effects of Exposure to Low Levels of Ionizing Radiation: BEIR V*, (Washington, DC: National Academy Press, 1990), pp. 172-173. Assuming a linear dose-response relationship (which is necessarily uncertain), an annual average exposure of 0.001 mrem then would produce a risk of excess cancer mortality of 0.00003 percent. If actual exposures approached the maximum exposure limit rather than ALARA, the best available information indicates that NRC's safety goal would *not* be met.

<sup>88</sup> U.S. Nuclear Regulatory Commission, *Severe Accident Risks: An Assessment for Five U.S. Nuclear power Plants*, NUREG-1 150, vol. 1 (Washington, DC: December 1990), p. 12-3.

<sup>89</sup> U.S. Bureau of the Census, *Statistical Abstract of the United States: 1992*, 112th ed. (Washington, DC: 1992), p. 82.

<sup>90</sup> J.I. Fabrikant, "Health Effects of the Nuclear Accident at Three Mile Island," *Health Physics*, vol. 40, February 1981, pp. 155-156.

### Box 2-1-Estimating Health Impacts From Public Radiation Exposure

There are two principal approaches to determining the public health impacts of normal nuclear power plant operations: 1) epidemiological studies comparing the health of populations living near plants to other populations, and 2) risk assessment, which involves estimating accident probabilities and their consequences in order to calculate exposure levels and health impacts.

Several epidemiological studies of public exposure from nuclear power plants and their health impacts have been performed, but results have varied. Some studies found increased cancer incidence, while others actually found decreased incidences.<sup>1</sup> At present, there are no national data that indicate that current public exposures to radiation from operating power plants produce detectable increases in cancer deaths.<sup>2</sup> Epidemiological studies of radiation cancer risks from nuclear power plants rarely, if ever, have enough information to provide complete or conclusive results, because the risk is generally too low to measure and data needs can be substantial. For example, researchers performing epidemiological studies must identify appropriate control populations, follow or obtain data on the status of exposed populations over long periods (generally decades), and obtain reliable data on cancer incidences and deaths from both study and control populations. Gathering such information over wide geographic areas is extremely difficult and requires an extended research commitment, in terms of both time and funds. In addition, cancer caused by radiation cannot generally be distinguished from cancer caused by other sources. This complicates efforts to identify sources of risk when there are detectable cancer increases in a study population exposed to low levels of radiation.

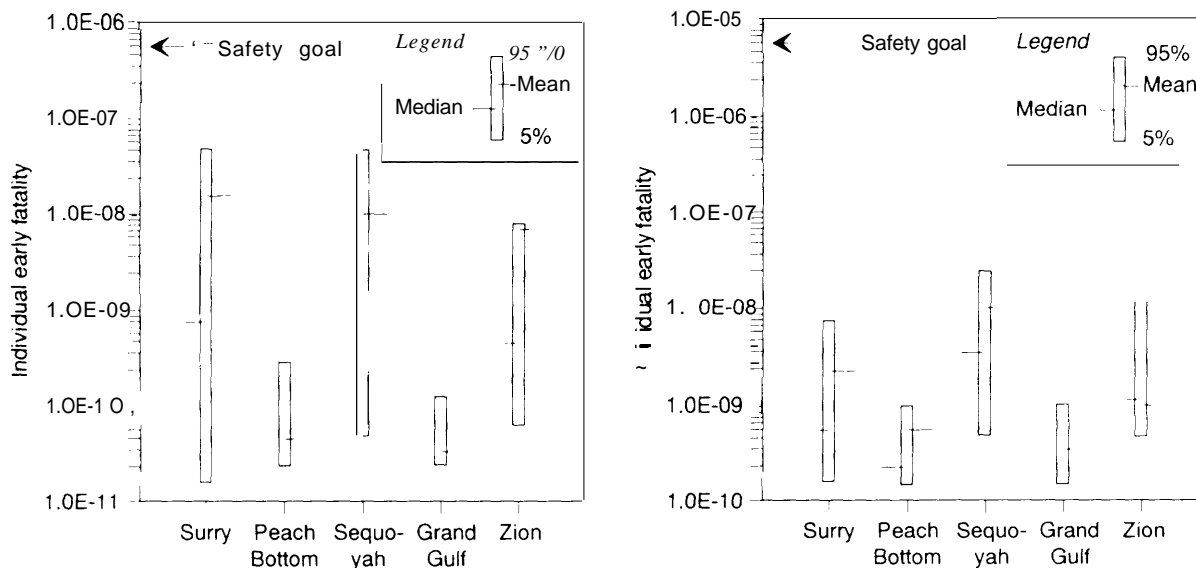
Furthermore, as many epidemiological studies of populations exposed to the very low levels of radiation associated with operating nuclear power plants have been inconclusive, current estimates of the radiation health impacts of low doses are generally based on data from high exposures—such as the atomic fallout from the 1945 bombing of Japan. These data are generally extrapolated linearly to estimate the risks of lower radiation doses, such as those experienced by residents near nuclear power plants. However, there are substantial uncertainties in extrapolating risk estimates from high doses to low doses.<sup>3</sup> In particular, risk may not have a linear relationship relative to dose but may, in fact, decrease below a certain dose threshold. On the other hand, the opposite may be true, and risks are likely to vary depending on other factors such as the age and health of a population. Thus, risk assessments based on linear dose-response relationships remain inherently uncertain.

<sup>1</sup> See, for example, committee on the Biological Effects of Ionizing Radiations, National Research Council, *Health Effects of Exposure to Low Levels of Ionizing Radiation: BEIR V* (Washington, DC: National Academy Press, 1990), pp. 377-379; and S. Jablon, Z. Hrubec, J.D. Boice, Jr., and B.J. Stone, National Cancer Institute, *Cancer in Populations Living Near Nuclear Facilities* (Washington, DC: U.S. Government Printing Office, July 1990), vol. 1, Report and Summary, pp. 8-15.

<sup>2</sup> In this context, a “detectable” increase is one that can be distinguished from the expected number of cases in a population. See S. Jablon, Z. Hrubec, and J.D. Boice, Jr., “Cancer in Populations Living Near Nuclear Facilities: A Survey of Mortality Nationwide and Incidence in Two States,” *The Journal of the American Medical Association*, Mar. 20, 1991, vol. 265, No. 11, pp. 1403-1408.

<sup>3</sup> See, for example, Committee on the Biological Effects of Ionizing Radiations, National Research Council, *Health Effects of Exposure to Low Levels of Ionizing Radiation: BEIR V* (Washington, DC: National Academy Press, 1990), pp. 1-8. As explained in this source, risk projections for solid tumors are linear, while those for leukemias are linear quadratic.

Figure 2-7-Comparison of Probabilistic Risk Assessment Results With Safety Goals (per reactor year)



SOURCE: U.S. Nuclear Regulatory Commission, *Severe Accident Risks: An Assessment for Five U.S. Nuclear Power Plants*, NUREG-1140, vol. 1 (Washington, DC: December 1990), p. 12-1.

breach at TMI, and the radiation released was low. People living within 10 miles of the plant, who experienced the highest estimated exposures, received an estimated average 6.5 milliems, a small fraction of the annual background radiation level. No radiation levels above background were detected beyond the 10-mile radius of the plant.

In contrast, the 1986 Chernobyl accident caused widespread release of large amounts of radionuclides and caused about 30 prompt fatalities--most of them emergency workers. The best estimate of resulting cancer fatalities is about 17,000, or about 0.01 percent above the background cancer fatality rate expected over the remaining lifetimes for the affected European population. The health risk to the population living near the plant is much greater. About 24,000 of the 115,000 people evacuated from the surrounding area received an average of 43 rems.

This dose is estimated to lead to an additional 26 fatal leukemias over their lifetimes, a risk increase of 200 percent for a group this size.<sup>91</sup>

The public risk from a nuclear accident depends on two factors: 1) the probability of a severe accident with a substantial offsite release of radiation, and 2) the consequences on the exposed population. Unmitigated aging degradation, or other factors that change over time, can affect both the probability of an accident and the severity of the consequences. For example, the probability of an accident involving a large release of radionuclides depends on the frequency of initiating events (e.g., human errors, equipment failures, loss of offsite power) and the subsequent events that might lead to reactor core and containment damage. Inadequately managed, aging degradation can increase the probability of equipment failure, thereby affecting both initiating events and the ability to manage an accident.

<sup>91</sup> M. Goldman, R. Catlin, and L. Anspaugh, *Health and Environmental Consequences of the Chernobyl Nuclear Power Plant Accident*, DOE/ER-0332 (Washington DC: Office of Energy Research, U.S. Department of Energy, June 1987), pp. vii-xv.

Offsite conditions may also change over time, such as changing population settlement patterns around a plant, and thus alter the potential consequences of an accident.

For decades, the NRC and the commercial nuclear power industry have worked to understand better and quantify public accident risks. In 1975, the NRC completed a much criticized study of the probabilities and consequences of severe accidents at two commercial nuclear facilities using PRA techniques for the first time.<sup>92</sup> Following the TMI accident, the NRC commissioned indepth PRAs of five nuclear plants representing major U.S. reactor designs (Zion, Surry, Sequoyah, Peach Bottom, and Grand Gulf).<sup>93</sup> For these “reference plants,” the NRC estimated mathematical probabilities of complex system failures and public health consequences. As estimated in that effort, the risks are at least one, and perhaps as many as five, orders of magnitude below the current NRC safety goal. The reference plant study did not explicitly address aging and assumed that aging management programs were sufficient to maintain current equipment performance.

Because small differences among otherwise similar plants can create significant differences in risk, the NRC in 1988 required all utilities to conduct probabilistic studies of their own plants called individual plant examinations (IPEs).<sup>94</sup> IPE results were intended to improve the under-

standing of the types of severe accidents possible at each plant and to ensure that no undetected, plant-specific accident vulnerabilities existed. Utilities are required to develop accident management methods for identified vulnerabilities.<sup>95</sup>

PRAs are subject to substantial uncertainties. Commenting on the NRC PRA study of five nuclear power plants, the Advisory Committee on Reactor Safeguards (ACRS) noted that the “results should be used only by those who have a thorough understanding of its limitations.”<sup>96</sup> These limitations include the following:

- limited historical information regarding the failure rates of critical equipment, particularly from aging effects;
- the difficulty of modeling human performance (e.g., the behavior of plant operators before and during an accident); and
- the lack of information regarding containment performance.

The cost of performing PRA analyses can be substantial; the NRC estimated that the IPE program would cost operators an average of between \$1.5 million to \$3 million per plant. Despite their limitations, PRA methods can be useful to identify risks and set priorities for additional research and analysis. Utilities have applied PRA methods and results to a variety of operations, maintenance, and economic decisions.<sup>97</sup>

---

<sup>92</sup> U.S. Nuclear Regulatory Commission, *Reactor Safety Study—An Assessment of Accident Risks in U.S. Commercial Nuclear Power Plants*, WASH-1400, NUREG-75-014 (Washington, DC: October 1975); and U.S. Congress, Office of Technology Assessment, *Nuclear Power in an Age of Uncertainty*, OTA-E-216, (Washington DC: U.S. Government Printing Office, February 1984), pp. 218-219. The NRC study was initiated by its predecessor agency, the AEC.

<sup>93</sup> U.S. Nuclear Regulatory Commission, *Severe Accident Risks: An Assessment for Five U.S. Nuclear Power Plants*, NUREG-1 150, vol. 1 (Washington DC: December 1990). That analysis is reviewed in American Nuclear Society, “Report of the Special Committee on NUREG-1 150, The NRC’s Study of Severe Accident Risks,” June 1990.

<sup>94</sup> D.M. Crutchfield, “Individual Plant Examination for Severe Accident Vulnerabilities,” U.S. Nuclear Regulatory Commission, Generic Letter 88-20, Nov. 23, 1988; and U.S. Nuclear Regulatory Commission, *Individual Plant Examination: Submittal Guidance*, NUREG-1335 (Washington, DC: August 1989).

<sup>95</sup> U.S. Nuclear Regulatory Commission, “Integration Plan for Closure of Severe Accident Issues,” SECY-88-147, May 25, 1988.

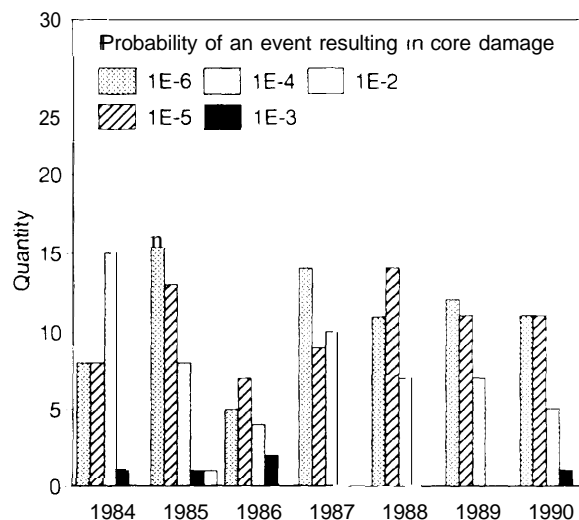
<sup>96</sup> U.S. Nuclear Regulatory Commission Advisory Committee on Reactor Safeguards, Letter to NRC Chairman Kenneth M. Carr, Subject: Review of NUREG-1150, “Severe Accident Risks: An Assessment for Five U.S. Nuclear Power Plants,” Nov. 15, 1990,

<sup>97</sup> Yankee Atomic Electric Co., *Applications of PRA*, EPRI NP-7315 (Palo Alto, CA: Electric Power Research Institute, May 1991).

To address aging issues more directly, the NRC NPAR program works to incorporate aging information into PRAs. Age-dependent PRAs model the effects of maintenance practices and the effects of aging on component failure rates, which standard PRAs assume are constant. These studies indicate that aging can have a substantial impact on reactor core damage if maintenance programs are inadequate.<sup>98</sup> However, age-dependent PRAs lack sufficient data to determine accurately aging effects on component failure rates and the effectiveness of different maintenance practices. As a result, they remain an area for continued analysis.<sup>99</sup>

Although accidents involving severe core damage are expected to be extremely rare (e.g., less than once per hundred years in the United States), there are actual operational experiences that can complement PRA results. In particular, NRC's Accident Sequence Precursor program tracks abnormal operating events<sup>100</sup> that could potentially lead to severe accidents.<sup>101</sup> The program uses PRA techniques to determine the significance of those events in terms of the likelihood of core damage. In 1990, 28 operational events were identified as resulting in probabilities of subsequent severe core damage of greater than one in one million. The worst six of those events were estimated to have core damage probabilities of between 1 in 1,000 to 1 in 10,000 (figure 2-8).<sup>102</sup> That is less, by a factor of between 1.7 and 18,

Figure 2-8—Accident Sequence Precursor Quantities, 1984-1990



SOURCE: U. S. Nuclear Regulatory Commission, 1991 Annual Report, NUREG-1145, vol. 8 (Washington, DC: July 1992), p. 52.

than would be expected based on a core melt frequency of one per 10,000 years per plant.

## Occupational Health Impacts

Nuclear power plant workers are generally exposed to more radiation than the residents neighboring their respective plants. Whereas the average member of the U.S. population is annually exposed to an effective total dose of 360 millirems (0.36 rems) from all sources,<sup>103</sup> current

<sup>98</sup> Science Applications International Corporation, *Evaluations of Core Melt Frequency Effects Due to Component Aging and Maintenance*, NUREG/CR-5510 (Washington, DC: U.S. Nuclear Regulatory Commission, June 1990); and U.S. Nuclear Regulatory Commission, *Regulatory Analysis for Final Rule on Nuclear Power Plant License Renewal*, NUREG-1362 (Washington DC: October 1991), appendix C.

<sup>99</sup> Science Applications International Corporation, *Approaches for Age-Dependent Probabilistic Safety Assessments with Emphasis on Prioritization and Sensitivity Studies*, NUREG/CR-5587 (Washington, DC: U.S. Nuclear Regulatory Commission, August 1992); and A.P. Donnell, Jr., Sandia National Laboratories, "A Review of Efforts to Determine the Effect of Age-Related Degradation on Risk," SAND91-7093, February 1992.

<sup>100</sup> Under 10 CFR 50.73, licensees must submit a Licensee Event Report (LER) when preestablished limits are exceeded or certain events occur. These reports serve as a primary source of operational event data. The threshold for reporting considers infrequent events of significance to plant and public safety as well as more frequent events of lesser significance that are more conducive to statistical analysis and trending.

<sup>101</sup> Oak Ridge National Laboratory, *Precursors to Potential Severe Core Damage Accidents: 1990 A Status Report*, -G/CR-4674 (Washington DC: U.S. Nuclear Regulatory Commission August 1991).

<sup>102</sup> U.S. Nuclear Regulatory Commission, *Annual Report 1991*, NUREG-1145, vol. 8 (Washington, DC: July 1992), p. 54.

<sup>103</sup> Committee on the Biological Effects of Ionizing Radiations, National Research Council, *Health Effects of Exposure to Low Levels of Ionizing Radiation: BEIR V*, (Washington DC: National Academy Press, 1990), pp. 18-19.

NRC regulations allow nuclear plant workers to receive as much as 3,000 millirems (3 rems) per calendar quarter up to a limit of 5,000 millirems (5 rems) per year, although ALARA goals encourage lower exposures.<sup>104</sup> The average annual measurable added radiation exposure for U.S. nuclear plant workers in recent years has been about 400 millirems.<sup>105</sup> Individual exposures vary, but few exceed the 5-rem limit. Between 1985 and 1989, only two of the approximately 210,000 monitored nuclear power plant workers experienced doses exceeding 5 rems.<sup>106</sup>

Increased maintenance activities associated with aging can increase occupational exposures. More frequent monitoring and testing of SSCs can lead workers to spend additional time in areas with concentrations of radionuclides. Major repairs also lead to additional exposures. For example, the additional collective exposures resulting from replacing a steam generator has been several hundred person-rems, the same order of magnitude as typical annual plant exposures otherwise occurring. However, for those plants requiring them, steam generator replacements are expected only once or twice over the life of a plant.

In 1991, the International Commission on Radiological Protection (ICRP), an international body established in 1928 to develop guidelines

for radiological health protection, recommended reducing the accepted levels of occupational radiation exposures from 5 rems per year to 2 rems per year, when averaged over a 5-year period (i.e., a total maximum of 10 rems over a 5-year period). The recommendation to limit the maximum occupational exposure in any single year to 5 rems was retained.<sup>107</sup> Although the NRC generally follows ICRP recommendations, an NRC decision to comply with the 1991 ICRP recommendation was postponed. As part of that decision, the NRC cited recently reduced U.S. occupational exposures from ALARA efforts to levels that already approximate the recent ICRP recommendations.<sup>108</sup>

Although occupational radiation exposures are carefully monitored, determining some of the incremental health risks to workers is difficult. For example, epidemiological studies of cancer risk lack reliable data on the risks of whole body radiation exposures below 10 rems (i.e., 10,000 millirems).<sup>109</sup> Nonetheless, the risk models in the BEIR V report estimate that a working lifetime exposure of 1,000 millirems annually (i.e., 1 rem per year each year between the ages of 18 and 65, or one-fifth the allowed maximum) will lead to an increased cancer mortality rate of roughly 15 percent above expected levels.<sup>110</sup>

<sup>104</sup> 10 CFR 20.101. In a recent rulemaking, the NRC decided to drop the quarterly limit. 56 *Federal Register* 23368, 23396 (May 21, 1991). This rule will be effective in 1994. 57 *Federal Register* 38588 (Aug. 26, 1992).

<sup>105</sup> C.T. Raddatz and D. Hagemeyer, *Occupational Radiation Exposure at Commercial Nuclear Power Reactors and Other Facilities: 1989, Twenty Second Annual Report*, NUREG-0713, vol. 11 (Washington, DC: U.S. Nuclear Regulatory Commission, April 1992), pp. 3-4. Note: The average measurable exposure differs from the average individual exposure, because not all nuclear plant workers show measurable exposures. If all workers are considered, the average individual dose for commercial nuclear plant workers is much lower (about 200 millirems in recent years).

<sup>106</sup> *Ibid.*, p. 5-10. Because 10 CFR Part 20 rules have allowed annual averaging, an individual exposure greater than 5 rems in any year was not automatically a violation, as long as the age-adjusted annual average remained at 5 rems or less. Under new rules taking effect in 1994, such averaging is no longer allowed, and 5 rems will be the maximum limit for each year.

<sup>107</sup> International Commission on Radiological Protection, 1990 *Recommendations of the International Commission on Radiological Protection*, ICRP Publication 60 (New York: Pergamon Press, 1991), pp. 72-73.

<sup>108</sup> 56 *Federal Register* 23360, 23363 (May 21, 1991).

<sup>109</sup> J.I. Fabrikant, "Health Effects of the Nuclear Accident at Three Mile Island," *Health Physics*, February 1981, vol. 40, p. 153. Note: This source actually notes 10 rads, but the units generally convert directly to rems on a 1:1 basis when considering gamma exposures, the exposure of concern with commercial nuclear power.

<sup>110</sup> Committee on the Biological Effects of Ionizing Radiations, National Research Council, *Health Effects of Exposure to Low Levels of Ionizing Radiation: BEIR V*, (Washington, DC: National Academy Press, 1990), pp. 172-173.

According to one source, the 107,019 workers exposed to the average 410 millirems in 1988 will experience a risk of additional cancer deaths of 0.2 percent (two cases per thousand); the single individual exposed to 6,100 millirems that year will experience an additional cancer mortality risk of 0.4 percent (four chances in one thousand).<sup>111</sup> As discussed earlier, however, there are many uncertainties associated with such estimates, particularly assumptions about the validity of transferring the results of high-dose exposures to low-level exposures.

The comparative occupational health risks between nuclear power and other energy sources, particularly coal, may be worth examining in more detail. Understanding these comparative

risks is important in evaluating the comparative risk-benefits of any energy source. Although all health effects, particularly deaths, are important, there are data that indicate the comparative occupational health risks associated with nuclear power are low relative to other energy sources. For example, the number of deaths and occupational injuries associated with coal production may be far higher than nuclear energy production.<sup>112</sup> OTA has not evaluated such claims for this report, but evaluating the merits of commercial nuclear power plant life attainment and license renewal requires a recognition, if not a complete understanding, of these comparative risks.

---

<sup>111</sup>C.T. Raddatz and D. Hagemeyer, *Occupational Radiation Exposure at Commercial Nuclear Power Reactors and Other Facilities: 1988*, Twenty First Annual Report, NUREG-0713, vol. 10 (Washington, DC: U.S. Nuclear Regulatory Commission July 1991), p. 4-29.

<sup>112</sup>J.I. Fabrikant, "Is Nuclear Energy An Unacceptable Hazard to Health?" *Health Physics*, September 1983, vol. 45, No. 3, p. 576.

# Economic Lives of Existing Nuclear Plants 3

**A** **11** power plants, nuclear and non-nuclear, will eventually be retired. Each nuclear plant's economic performance (i.e., the cost of producing electricity while meeting Nuclear Regulatory Commission (NRC) and other safety requirements) plays a prominent role in plant life decisions. The cost and availability of alternative resources is also critical. Both the economic performance of nuclear plants and the cost of alternatives are debated, changing, and highly diverse. For this reason, economic life decisions are likely to be determined over time, as individual conditions change based on a host of separate decisions by utilities, State utility commissions, and Federal regulators. The cost of managing aging, while potentially large for some plants, is only one aspect of economic life decisions.

This chapter examines economic issues related to nuclear power plants. The discussion centers on the following:

- the changing context of the electric utility industry as it relates to nuclear plant life decisions,
- institutions involved and their roles in evaluating the economic lives for existing nuclear plants,
- the economic performance of existing nuclear plants, and
- some factors affecting future nuclear plant cost and performance.

## THE CHANGING ELECTRIC UTILITY CONTEXT

The electric utility industry is evolving rapidly. Pressures for change started two decades ago with widely fluctuating fuel prices, plummeting demand growth, hefty increases in the construction costs of large power plants, and increased attention to the environmental impacts of electricity generation. More recently, supply competition and utility energy efficiency efforts have increased markedly. These changes have reduced some of

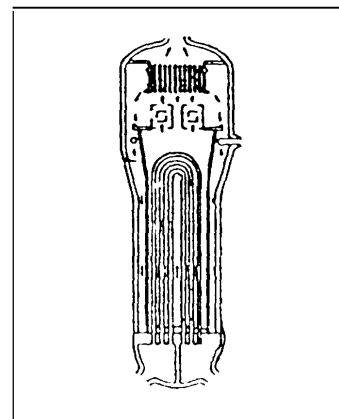
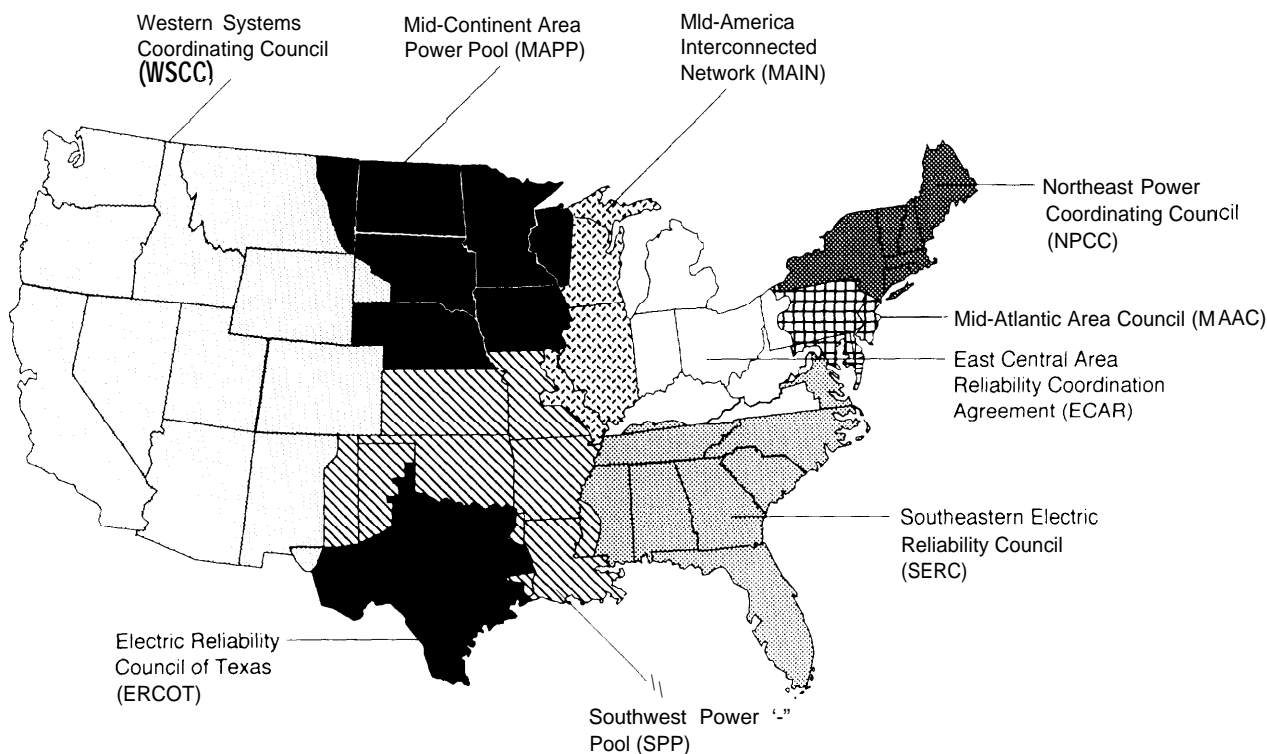




Figure 3-1—Electric Regions in the Contiguous United States



SOURCE: U.S. Congress, Office of Technology Assessment, *Electric Power Wheeling and Dealing: Technological Considerations for Increasing Competition*, OTA-409 (Washington, DC: U.S. Government Printing Office, May 1989), p. 159.

the costs of replacement power, placing additional economic pressures on existing nuclear and non-nuclear plants. Increasingly, utilities and their economic regulators are engaging in elaborate economic analyses and planning efforts known as integrated resource planning (IRP) or least-cost planning (LCP). The growing use of IRP both addresses and contributes to the changing utility context, as discussed later.

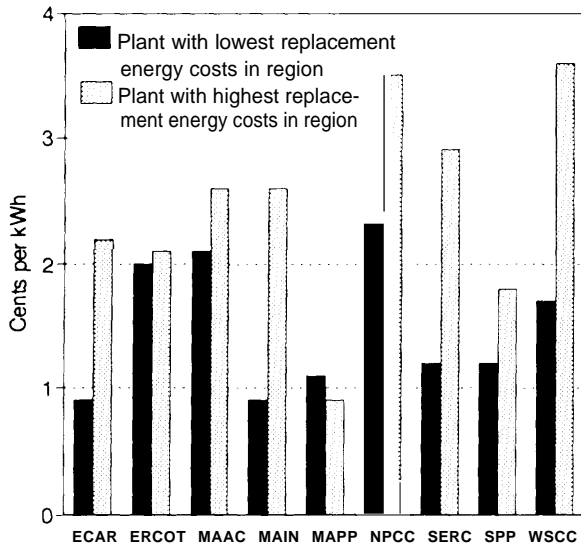
In addition to change, electric market conditions across the Nation are diverse. The electric power industry nationwide is subdivided by the nine regions of the North American Electric Reliability Council (NERC) (see figure 3-1), each

comprised of many individual, but interconnected, utilities that often form separate power pools.<sup>1</sup> The U.S. electric power industry is a diverse and complex arrangement of investor- and consumer-owned utilities, government agencies, and independent power producers. Regional differences in generation reserve margins, fuel mix, and load growth reflect differing patterns of population, climate, economic activities, and the history of utility policy and regulation. One overall indicator of these differences is the range of regional values for replacement power, which vary widely across the country (see figure 3-2).<sup>2</sup>

<sup>1</sup> U.S. Congress, Office of Technology Assessment, *Electric Power Wheeling and Dealing: Technological Considerations for Increased Competition*, OTA-E409 (Washington DC: U.S. Government Printing Office, May 1989), ch. 6.

<sup>2</sup> J.C. Van Kuiken et al., *Replacement Energy Costs for Nuclear Electricity-Generating Units*, NUREG/CR-4012 (Washington DC: U.S. Nuclear Regulatory Commission October 1992).

Figure 3-2—Diversity in Replacement Energy Costs for Nuclear Power Within and Among Regions, 1992



NOTE: These are estimated replacement energy costs for short-term nuclear plant outages for 1992.

SOURCE: J.C. Van Kuiken et al., *Replacement Energy Costs for Nuclear Electricity Generating Units*, NUREG CR-4012 (Washington, DC: U.S. Nuclear Regulatory Commission, October 1992), pp. 79-190.

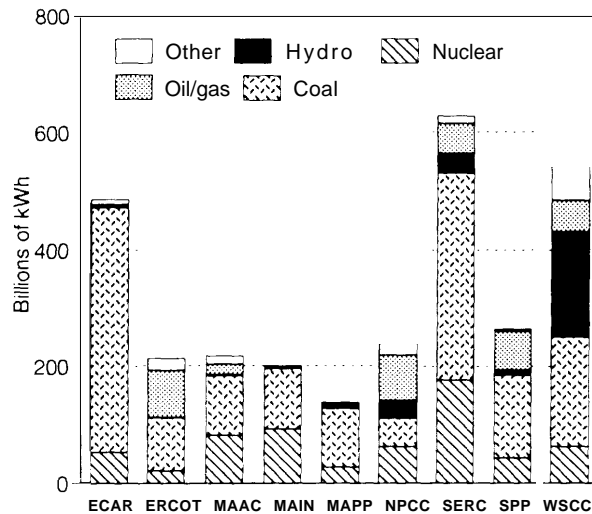
These diverse factors can contribute to differing prospects for existing nuclear plants.

As shown in figure 3-3, the use of nuclear power differs greatly among U.S. regions. For example, in 1991, nuclear power supplied about 77 percent of the electricity in the Commonwealth Edison Co. (CECO) subregion of the NERC Mid-American Interconnected Network.<sup>3</sup> By contrast, there are no operating nuclear power plants in the Rocky Mountain Power Area subregion of the NERC Western System Coordinating Council.

### ■ Electricity Demand and Capacity Margins

Slack electricity demand and surplus generating capacity have been among the factors noted in

Figure 3-3—U.S. Regional Electricity Supplies by Fuel, 1991

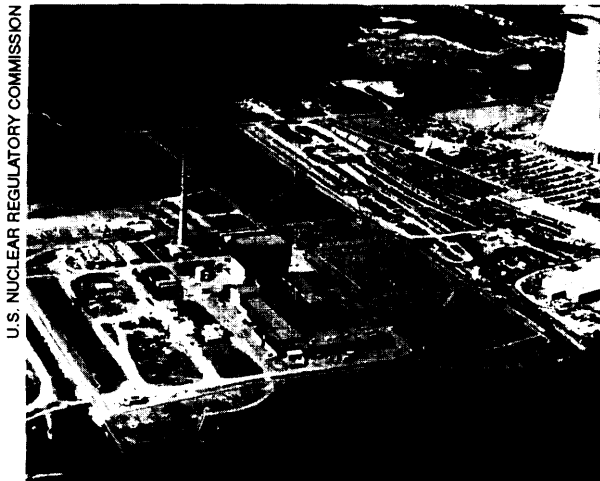


SOURCE: North American Electric Reliability Council, *Electricity Supply and Demand 1992-2001* (Princeton, NJ: NERC, June 1992), pp. 44-60.

some nuclear power plant early retirement analyses. For example, owners of the retired Yankee Rowe plant noted that a regional recession turned a capacity constrained situation into one of excess capacity, reducing the need for the plant. Similarly, Niagara Mohawk's 1992 analysis of the Nine Mile Point Unit 1 plant indicated for the first time that early retirement might be economic, in large part due to a substantially higher forecast of the amount of non-utility generation available.<sup>4</sup> However, that forecast is uncertain and based on a now-repealed State law that provided a strong economic incentive to non-utility generators. In the case of the New York Power Authority's (NYPA) Fitzpatrick plant, NYPA's chairman noted that a planned non-utility generator was uneconomical and unnecessary, but if developed,

<sup>3</sup> North American Electric Reliability Council, *Electricity Supply & Demand 1992-2001* (Princeton, NJ: June 1992), pp. 44,46.

<sup>4</sup> Niagara Mohawk, "Economic Analysis of Continued Operation of the Nine Mile Point Unit 1 Nuclear Station," Nov. 20, 1992; and R.R. Zuercher, "Nine Mile Point-1 May Be Next to Fall to Unfavorable Nuclear Economics," *Nucleonics Week*, vol. 33, No. 49, Dec. 3, 1992, pp. 1, 14-15.



*The Fitzpatrick Nuclear Power Plant in New York is among the plants that have reported facing increased economic pressures.*

it would result in a surplus of capacity, making Fitzpatrick uneconomical.<sup>5</sup>

Nationwide, electricity consumption has continued to grow since the earliest nuclear power plants began operation (see figure 3-4). However, annual growth rates declined by nearly a factor of three between the 1960s and the 1980s. Capacity margins<sup>6</sup> remain high in many regions, because construction has been completed on plants begun years earlier under assumptions of more rapid growth (see figure 3-5). All but one of the nine NERC regions plan to reduce capacity margins over the decade.<sup>7</sup> Still, utilities and the Energy Information Administration (EIA) project that substantial amounts of new generating capacity (about equal to the total installed nuclear capac-

ity) will be needed in most areas of the Nation during this decade.<sup>8</sup> However, much of this will be for meeting peak loads rather than for the baseload power supplied by nuclear plants. EIA projects that existing capacity will be fully used after 2000, and new baseload plants will then be required.

As the sharp, unexpected declines in demand growth between the 1960s and the 1980s demonstrated, predicting future demand can be highly uncertain. The EIA projects that annual electricity demand growth between 1990 and 2010 may range from 1.3 to 1.9 percent.<sup>9</sup> For context, even the small divergence between these estimates represents about 400 billion kilowatthours (kWh) in the year 2010, roughly two-thirds the electric output of all currently operating U.S. nuclear power plants. Moreover, such broad national averages may mask greater diversity and uncertainty at the regional level.

## ■ Competitive Resources

The emergence of a variety of low-cost electricity resources has already altered the economic outlook for nuclear power at several utilities. Two particularly prominent developments have affected competition for existing nuclear plants: 1) the increasing use of natural gas as a low cost and convenient fuel for new electricity generation; and 2) the recent surge in utility demand-side management (DSM) efforts,<sup>10</sup> a trend likely to continue given the large, untapped potential for

<sup>5</sup> D. Airozo and R.R. Zuercher, "Gas Plant Competition Could Kill Fitzpatrick, NYPA Chief Claims," *NucleonicsWeek*, vol. 33, No. 39, Sept. 24, 1992, p. 8.

<sup>6</sup> Capacity margins are the fraction of generating capacity in excess of peak demand available to provide for emergency outages, maintenance, system operating requirements, and unforeseen electricity demand.

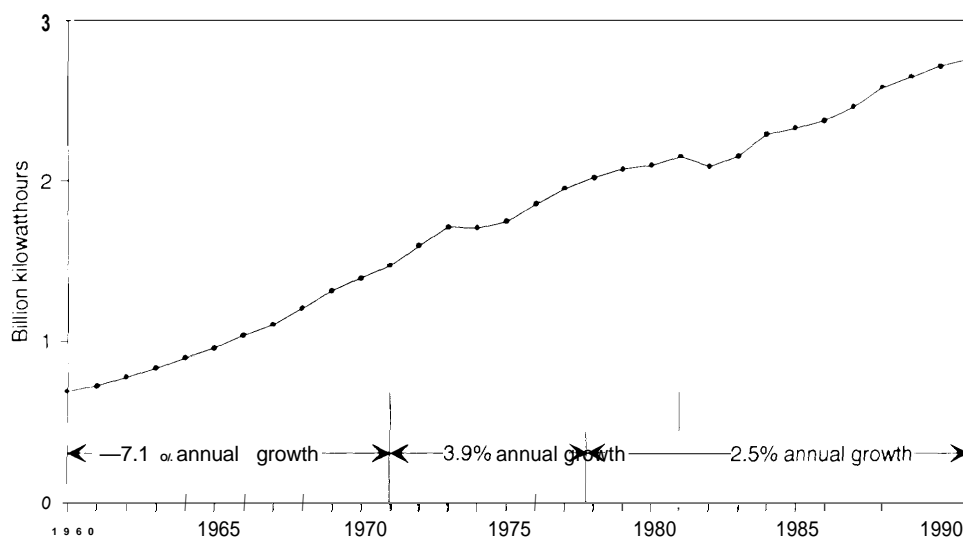
<sup>7</sup> North American Electric Reliability Council *Electricity Supply and Demand 1992-2001* (Princeton, NJ: June 1992).

<sup>8</sup> U.S. Department of Energy, Energy Information Administration, *Annual Energy Outlook 1993, DOE/EIA-0383(93)* (Washington, DC: January 1993), p. 51.

<sup>9</sup> *ibid.*, p. 49.

<sup>10</sup> For an indepth discussion of utility demand-side management, see U.S. Congress, Office of Technology Assessment *Energy Efficiency: Challenges and Opportunities for Electric Utilities*, forthcoming.

Figure 3-4—Electricity Sales, 1960-1991



SOURCE: U.S. Department of Energy, *Annual Energy Review 1991*, DOE/EIA-0384(91), June 1992, p. 219.

highly economic energy efficiency improvements.<sup>11</sup>

In the decision to retire the Trojan plant, Portland General Electric (PGE) assumed that new low-cost resources, primarily DSM, would be developed to replace the plant's output.<sup>12</sup> Notably, PGE's analysis projected that DSM could reasonably meet more than 10 percent of the utility's total energy requirements by the year 2012. Low-cost replacement power and prospective efficiency gains also played roles in the economic analyses of the San Onofre Nuclear Generating Station Unit 1 (SONGS-1).<sup>13</sup> The cost-benefits of needed capital additions at both of these plants were diminished, in part, because of determinations that gas-fired capacity and

energy efficiency would be more economic over the long term. Similarly, in commenting on the outcome of the 1989 early retirement of the Rancho Seco plant, officials of the Sacramento Municipal Utility District have noted that reliance on natural gas and DSM have turned out to be economic choices.

Competition from natural gas generation or DSM has also been cited as challenging the economic prospects of other operating nuclear plants. For example, the operators of the Kewaunee plant determined that early retirement and replacement with a new gas-fired plant may be more economical than pursuing steam generator replacement in 1998, 15 years prior to license expiration.<sup>14</sup> For both the Fitzpatrick and Nine

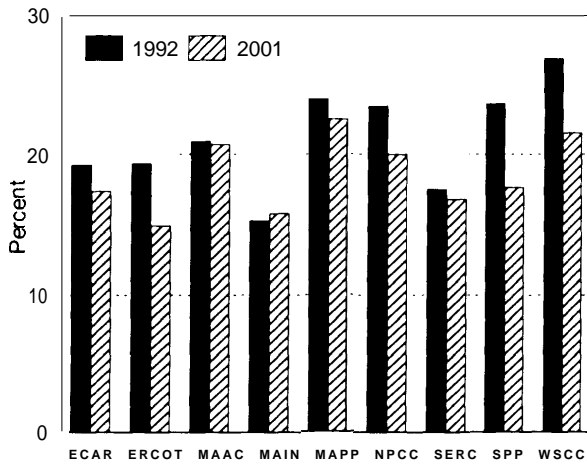
<sup>11</sup>See U.S. Congress, Office of Technology Assessment, *Building Energy Efficiency*, OTA-E-518 (Washington, DC: U.S. Government Printing Office, May 1992); and U.S. Congress, Office of Technology Assessment, *Energy Efficiency in the Federal Government: Government by Good Example?*, OTA-E-492 (Washington, DC: U.S. Government Printing Office, May 1991).

<sup>12</sup>Portland General Electric, *1992 Integrated Resource Plan*, Nov. 13, 1992, p. 4A.3.

<sup>13</sup>E. Hiruo, "San Onofre-1 Shutdown Minks Era of Least-Cost Plans," *Nucleonics Week*, vol. 33, No. 47, Nov. 19, 1992, p. 7; J.J. Wambold, Manager of projects, Nuclear Engineering, Safety and Licensing, Southern California Edison Co., personal communication with OTA, Oct. 14, 1992; Portland General Electric, *1992 Integrated Resource Plan*, Nov. 13, 1992, ch. 4a (Trojan Analysis).

<sup>14</sup>D. Stellfox, "Risk of Premature Shutdown Grows; Kewaunee, Ft. Calhoun on Guard," *Nucleonics Week*, vol. 33, No. 36, Sept. 3, 1992, pp. 1, 11-12.

**Figure 3-5-Current and Forecast Regional Capacity Margins, Summer 1992,2001**



SOURCE: North American Electric Reliability Council, *Electricity Supply & Demand 1992-2&21* (Princeton, NJ: June 1992).

Mile Point plants discussed above, the planned or assumed nonutility generation capacity is expected to be fueled primarily by natural gas.<sup>15</sup> Noting the option of new gas-fired combustion turbines, Bonneville Power Administration has indicated that if performance at the Washington Public Power Supply System's nuclear plant does not improve within 2 or 3 years, it will consider

alternatives to its 300-megawatt (MW) stake in the plant.<sup>16</sup>

Some analysts have raised questions about the future availability and cost of natural gas supplies.<sup>17</sup> U.S. electric utilities plan to add more natural gas-fired capacity than any other generating source in the next decade; the gas share is expected to total 54 percent of the nearly 60,000 MW utilities plan to add between 1992 and 2001.<sup>18</sup> By 2010, according to EIA projections, natural gas will generate more electricity in the United States than nuclear power.<sup>19</sup> Overall, projections of future natural gas prices will remain a subject of debate, and whether fixed-prices available in long-term gas contracts will remain low long enough to spur the early retirement of more nuclear units remains speculative.

Increasing competition in the electric power industry from independent power producers and wider transmission access are among the forces affecting the cost of replacement power and, thus, future plant economics.<sup>20</sup> Independent power producers, foster encouraged under the Public Utility Regulatory Policies Act of 1978 (PURPA)<sup>21</sup> and further encouraged by the Energy Policy Act of 1992 (EPACT),<sup>22</sup> have become a major force in the electric industry and account for a rapidly

<sup>15</sup> D. Airozo and R.R. Zuercher, "Gas plant Competition Could Kill Fitzpatrick NYPA Chief Claims," *Nucleonics Week*, vol. 33, No. 39, Sept. 24, 1992, p. 8; R.R. Zuercher, "Nine Mile Point-1 May Be Next to Fall to Unfavorable Nuclear Economics," *Nucleonics Week*, vol. 33, No. 49, Dec. 3, 1992, pp. 1, 14-15.

<sup>16</sup> "Improve Nuclear Unit Performance or Shut it Down, BPA Tells WPPSS," *Electric Utility Week*, May 31, 1993, p. 4.

<sup>17</sup> North American Electric Reliability Council, *Reliability Assessment 1992-2001: The Future of Bulk Electric Supply in North America* (Princeton, NJ: September 1992), pp. 26-28; T. Moore, "Natural Gas for Utility Generation" *EPRI Journal*, vol. 17, No. 1, January/February 1992, pp. 5-10.

<sup>18</sup> North American Electric Reliability Council, *Electricity Supply & Demand 1992-2001: Summary of Electric Utility Supply & Demand Projections* (Princeton: June 1992), pp. 94, 101-107.

<sup>19</sup> EIA Projects that natural gas will generate about 18 percent (or 735 billion kilowatthours), and nuclear power about 15.5 percent (or 636 billion kilowatthours), of U.S. electricity in 2010. These figures reflect the EIA reference (business-as-usual) case. U.S. Department of Energy, Energy Information Administration, *Annual Energy Outlook 199-?: With Projections to 2010*, DOE/EIA-0383(93) (Washington, DC: January 1993), p. 49.

<sup>20</sup> U.S. Congress, Office of Technology Assessment, *Electric Power Wheeling and Dealing: Technological Considerations for Increased Competition*, OTA-E-409 (Washington, DC: U.S. Government Printing Office, May 1989).

<sup>21</sup> Public Utility Regulatory Policies Act of 1978, Public Law 95-617, Nov. 9, 1978.

<sup>22</sup> The Energy Policy Act of 1992, Public Law 102-486, Oct. 24, 1992.

growing share of new generation. Many States, utilities, and the Federal Energy Regulatory Commission (FERC) have sought to promote competitive bidding and independent power production.

### ■ Addressing Environmental Concerns

As with many industrial activities, electricity generation can cause major environmental impacts. Increasing attention to the environmental impacts of both fossil fuel combustion and nuclear generation creates a source of substantial uncertainty in future electricity markets. With respect to nuclear plant economics, two different types of environmental impacts are relevant:

1. the environmental benefits of reducing fossil fuel use, and
2. the environmental costs imposed by nuclear power plants.<sup>23</sup>

Utility IRP often includes scenarios investigating the impacts of such prospective environmental costs. In general, estimating and applying the economic costs associated with different types of environmental impacts is highly complex, remains a subject of substantial debate, but is a rapidly evolving field.<sup>24</sup>

Two major environmental concerns related to fossil fuel combustion may improve the relative economic attractiveness of existing nuclear plants: global climate change and acid deposi-

tion.<sup>25</sup> All fossil fuel power plants produce carbon dioxide (CO<sub>2</sub>), a gas that many experts believe may contribute to severe global climate change if not controlled in coming decades.<sup>26</sup> U.S. CO<sub>2</sub> emissions represent about 20 percent of total annual global emissions, with electric utilities responsible for about one-third of this amount. In a recent report, OTA estimated that under present conditions the annual carbon emissions from U.S. electrical utilities to the Nation's total could increase to as much as 45 percent by 2015.<sup>27</sup>

Predicting what future efforts will be taken to address CO<sub>2</sub> emissions remains speculative. However, efforts to control these emissions could have profound impacts. For example, consider a hypothetical \$100 per ton carbon tax, which one Congressional Budget Office study estimated could potentially reduce CO<sub>2</sub> emissions between zero and 25 percent from current levels over a 10-year period.<sup>28</sup> Such a tax alone would translate into approximately \$0.03/kWh for coal-fired electric generation, more than the average operational costs at existing nuclear power plants. The prospective cost of controlling CO<sub>2</sub> emissions is increasingly being considered in IRP. The resulting impacts can determine the economic attractiveness of a plant. For example, in its analyses of early retirement for the Trojan nuclear plant, PGE examined CO<sub>2</sub> tax scenarios of \$0, \$10, and \$40 per ton.<sup>29</sup> While the analyses showed that a high CO<sub>2</sub> tax would make continued operation the

<sup>23</sup> The NRC's environmental assessment of the license renewal rule discussed the costs of continued nuclear plant operation. U.S. Nuclear Regulatory Commission, *Environmental Assessment for Final Rule on Nuclear Power Plant License Renewal*, NUREG-1398, October 1991.

<sup>24</sup> See, e.g., Pace University Center for Environmental Legal Studies, *Environmental Costs of Electricity* (New York, NY: Oceana Publications, 1990).

<sup>25</sup> Other resources, such as renewable energy and energy efficiency measures, do not produce CO<sub>2</sub> emissions and would also have relatively improved economics. Natural gas and petroleum-fired generation produce about half the CO<sub>2</sub> per unit of electricity as does coal and could be affected as well. The dominant role of coal, which supplies 55 percent of the Nation's electricity, makes it likely that aggressive action to control CO<sub>2</sub> emissions would affect all aspects of the electricity market.

<sup>26</sup> See, generally, J.B. Smith and D. Tirpak (eds.), Office of Policy, Planning and Evaluation, U.S. Environmental Protection Agency, *The Potential Effects Of Global Climate Change On The United States*, EPA-230-05-89-050 (Washington DC: December 1989).

<sup>27</sup> U.S. Congress, Office of Technology Assessment, *Changing by Degrees: Steps to Reduce Greenhouse Gases*, OTA-O-482 (Washington, DC: U.S. Government Printing Office, February 1991), pp. 3, 25.

<sup>28</sup> U.S. Congress, Congressional Budget Office, *Carbon Charges as a Response to Global Warming: The Effects of Taxing Fossil Fuels* (Washington, DC: U.S. Government Printing Office, August 1990).

<sup>29</sup> A tax of \$40 per ton of CO<sub>2</sub> is equivalent to a tax of \$147 per ton "C."

most economic option, PGE viewed that future as having a low probability of occurrence.<sup>30</sup>

Fossil-fired power plants are also responsible for sulfur dioxide (SO<sub>2</sub>) and nitrogen oxide (NO<sub>x</sub>) emissions leading to acid deposition. SO<sub>2</sub> emissions and acid rain have serious, but generally local or regional, effects: surface water acidification, fish losses, forest damage and decline, materials and cultural impacts, reduced visibility, and both direct and indirect human health effects.<sup>31</sup> Of the estimated 23 million tons of SO<sub>2</sub> emitted in the United States in 1987, over two-thirds stemmed from electric utilities.<sup>32</sup> Electric utilities are also responsible for about one-third of the 18.6 million tons of NO<sub>x</sub> emitted annually in the United States.<sup>33</sup> The NO<sub>x</sub> controls and SO<sub>2</sub> emission ceilings and emission trading provisions of the Clean Air Act Amendments of 1990 (CAAA)<sup>34</sup> may have large but still unclear economic impacts on some existing coal plants.<sup>35</sup>

In contrast to the environmental challenges of fossil fuel combustion involving large volumes of SO<sub>2</sub>, CO<sub>2</sub>, NO<sub>x</sub>, and coal ash, unique environmental challenges of nuclear plants involve relatively small volumes of materials with sometimes high levels of radioactivity. Although most of the volume of radioactive waste from nuclear plants contains very low levels of radioactivity, handling, managing, and disposing all radioactive

waste from nuclear plants can be difficult and costly. One potential environmental cost of nuclear plants that has been raised in IRP, in addition to waste disposal, is the low probability, but high consequence, risk of a nuclear plant accident. For example, as part of its IRP, PGE estimated the expected environmental costs associated with nuclear plant accidents to be between zero and about one-half cent per kWh.<sup>36</sup> This estimate assumed that the maximum amount of potential damage is no more than \$35 billion, several times more than the approximately \$7 billion liability limit set by the Price Anderson Act.<sup>37</sup> For conservatism, PGE assumed the risk to be 1/1000 per reactor year of operation. Others have estimated both higher and lower expected environmental costs. For example, a Pace University Center for Environmental Legal Studies report estimated a cost of about 2.3 cents/kWh<sup>38</sup>, while one study for Yankee Atomic Electric Co. estimated a cost nearly three orders of magnitude less.<sup>39</sup>

There are other environmental impacts with less sweeping national implications that may have important impacts on plant economics. All nuclear and fossil steam power plants can raise the temperature of the local cooling water used, producing thermal plumes and altering oxygen demands, both of which can affect aquatic life near power facilities. For example, one analysis

<sup>30</sup> Portland General Electric, *1992 Integrated Resource Plan*, Nov. 13, 1992, p. 4A.3.

<sup>31</sup> National Acid Precipitation Assessment Program, *1990 Integrated Assessment Report* (Washington, DC: November 1991).

<sup>32</sup> *Ibid.*, p. 198.

<sup>33</sup> Based on an estimate for 1985. National Acid Precipitation Assessment Program, 1989 *Annual Report of the National Acid Precipitation Assessment Program* (Washington, DC: June 1990), p. F-43.

<sup>34</sup> Clean Air Act Amendments of 1990, Public Law 101-549, Nov. 15, 1990, Title IV.

<sup>35</sup> U.S. Department of Energy, Energy Information Administration, *Annual Outlook for U.S. Electric Power 1991: Projections Through 2010*, DOE/EIA-0474(91) (Washington, DC: July 1991), p. 25.

<sup>36</sup> In addition, other external nuclear environmental costs associated with waste disposal, routine operations, and fuel mining and processing were estimated to total about 0.15 cents/kWh. Portland General Electric, *1992 Integrated Resource Plan*, Nov. 13, 1992, app. 7.

<sup>37</sup> 42 USC 2208 *et. seq.*

<sup>38</sup> Pace University Center for Environmental Legal Studies, *Environmental Costs of Electricity*, 1990.

<sup>39</sup> Energy Research Group, Inc., "Environmental Externalities and Yankee Nuclear Power Station," November 1991, as reported in Portland General Electric, *1992 Integrated Resource Plan* Nov. 13, 1992, app. 7.

of the impact on the marine environment from operation of SONGS-1 estimated an economic loss of about \$6 million annually.<sup>40</sup> Coal plants produce vast volumes of ash, which is often laced with heavy metals and radionuclides. Hydro-power, the major renewable source of electrical energy currently used in the United States, can also have major impacts, mainly by flooding large areas and causing perturbations in stream flows, fish migrations, water temperatures, and oxygen levels.

### INSTITUTIONAL ISSUES IN NUCLEAR PLANT ECONOMIC LIFE DECISIONS

The objectives in nuclear plant life decisions stem from broader electric power system objectives, including the following:

- assuring adequate supplies to meet demand;
- minimizing the costs of electricity (including, increasingly, environmental costs);
- equitably treating both electricity consumers and plant owners in the recovery of costs; and
- increasingly, responding to intensifying market forces in the electric power industry.

Responsibility for the economic performance of existing nuclear power plants lies with the utilities owning and operating them.<sup>41</sup> So, too, does the ultimate responsibility for economic decisions regarding nuclear power plant lives.

Industrywide groups such as the Nuclear Management and Resources Council (NUMARC), the Institute of Nuclear Power Operations (INPO), the Electric Power Research Institute (EPRI), and the Edison Electric Institute (EEI) address issues related to plant economies as well. For example, INPO, NUMARC, EEI, and EPRI are participating in an "Industrywide Initiative" to improve nuclear plant economic performance.<sup>42</sup> NUMARC's principal role is to identify and eliminate unnecessary or inefficient NRC regulatory activities leading to unnecessary costs.<sup>43</sup> EEI is helping utilities address economic regulatory issues, including application of IRP. EPRI's principal role is to assist utilities with the application of proven technology to reduce costs and achieve benefits in plant reliability, productivity and thermal efficiency. In addition, EPRI is continuing its two decade research effort to develop more economic technologies for safe operation and maintenance (O&M) of existing nuclear power plants.<sup>44</sup>

All but about 8 of the 107 operating nuclear plants in the United States are primarily owned by investor-owned utilities and fall under FERC or State economic regulation.<sup>45</sup> For these plants, economic decisions are typically made by the plant owners in conjunction with the respective

<sup>40</sup> California Public Utilities Commission, Division of Ratepayer Advocates (CPUCDRA), "Report on the Cost-Effectiveness of Continued Operation of the San Onofre Nuclear Generating Station Unit No. 1," Investigation 89-07-004, Sept. 25, 1991. According to CPUCDRA staff, revised cost estimates of marine damage indicate that the cost is higher, on the order of \$15 million annually. Robert Kinoshian, CPUC Division of Ratepayer Advocates, letter to the Office of Technology Assessment, Feb. 8, 1993.

<sup>41</sup> Nearly half of the 108 operating nuclear power plants are jointly owned by two or more utilities. The remainder are solely owned. In total, over 130 utilities have some share of existing plants. R.S. Wood, U.S. Nuclear Regulatory Commission, *Owners of Nuclear Power Plants*, NUREG-0327, Rev. 5 (Washington, DC: July 1991). For those, economic decisions are shared by the owners.

<sup>42</sup> "EEI to Help Nuclear Move Ahead in Changing power Marketplace," *Nucleonics Week*, vol. 34, No. 25, June 24, 1993, pp. 1,12-13.

<sup>43</sup> Nuclear Management and Resources Council, *Review of Operations and Maintenance Costs in the Nuclear Industry*, NUMARC 92-03 (Washington DC: December 1992), pp 54-56.

<sup>44</sup> See, e.g., Grove Engineering, Inc., *Long-Term Capital Planning Considering Nuclear Plant Life-Cycle Management*, EPRI TR-101162 (Palo Alto, CA: Electric Power Research Institute, September 1992).

<sup>45</sup> Five of the Nation's 108 operating nuclear power plants are publicly owned (e.g., by a public power authority or rural Cooperative). Three others are owned by the Tennessee Valley Authority (TVA), and are not subject to FERC or State economic regulation. TVA also has two previously operating units with full power licenses under review (Browns Ferry 1 and 3). Many public power utilities also share joint ownership of existing nuclear plants operated by investor-owned utilities.



economic regulatory bodies.<sup>46</sup> While economic regulatory activities vary greatly by State, many States play a strong role in promoting and applying economic analyses to utility investment and retirement decisions. For example, many States require their respective utilities to perform IRP.

The public also has a role in the regulatory activities related to plant economics. For example, the definition of IRP in the Energy Policy Act of 1992 (EPACT) specifically requires including public participation and comment in development of the plan.<sup>47</sup> The public may also raise economic issues in NRC licensing actions. For example, following the request of Pacific Gas and Electric Co. (PG&E) to extend the license expiration dates for the Diablo Canyon nuclear plants by recapturing the plants' construction periods (see ch. 2), one public interest group and the State of California received NRC approval to intervene in the case.<sup>48</sup> The opposition was not related to plant safety, but rather to a concern that extended operation would increase electricity rates and harm the State's economy.

## ■ Integrated Resource Planning and Nuclear Plant Economic Analyses

Nearly all States that regulate nuclear utilities require IRP already and all will eventually consider its use, as required by EPACT.<sup>49</sup> EPACT also requires the Tennessee Valley Authority to perform LCP in making resource decisions. While IRP is not necessarily directed at examin-

ing nuclear plant life decisions, it can and has been. For example, PGE's decision to retire the Trojan nuclear power plant was examined and supported in PGE's 1992 Integrated Resource Plan, a planning exercise required by the Oregon Public Utilities Commission.<sup>50</sup> Also, the New York Public Service Commission has required regulated utilities in the State to examine the economics of continued nuclear plant operation.<sup>51</sup>

Change and uncertainty are hallmarks of the electric utility industry's planning challenge. For this reason, planning methods generally consider a range of possible scenarios rather than attempt to forecast accurately inherently uncertain future conditions. For example, in its analysis of the economics of continued operation or early retirement for the Trojan plant, PGE examined a range of natural gas prices, electrical demands, and plant costs and performance. Depending on the assumptions used, PGE's probabilistic analysis indicated a range of net present value of continued operation between -\$1.8 billion to +\$1 billion (see figure 3-6).<sup>52</sup> This wide range of possible outcomes suggests that plant life decisions may depend on highly uncertain factors.

Because many factors in economic analyses are inherently uncertain, disagreements about appropriate decisions should not be surprising. Rather than finding one clearly optimal choice, plant economic decisions involve professional judgments that attempt to balance alternative choices and their uncertain outcomes. Some have sug-

<sup>46</sup> In some cases (e.g., utility holding companies), economic regulation of utility performance rests with both the State utility commission and the Federal Energy Regulatory Commission. For a discussion of Federal and State jurisdiction, see U.S. Congress, Office of Technology Assessment *Electric Power Wheeling and Dealing: Technological Considerations for Increasing Competition*, OTA-E-409 (Washington, DC: U.S. Government Printing Office, May 1989), ch. 2.

<sup>47</sup> Energy Policy Act of 1992, Public Law 102-486, Sec. 111.

<sup>48</sup> Federal Register Feb. 2, 1993, pp. 68278.

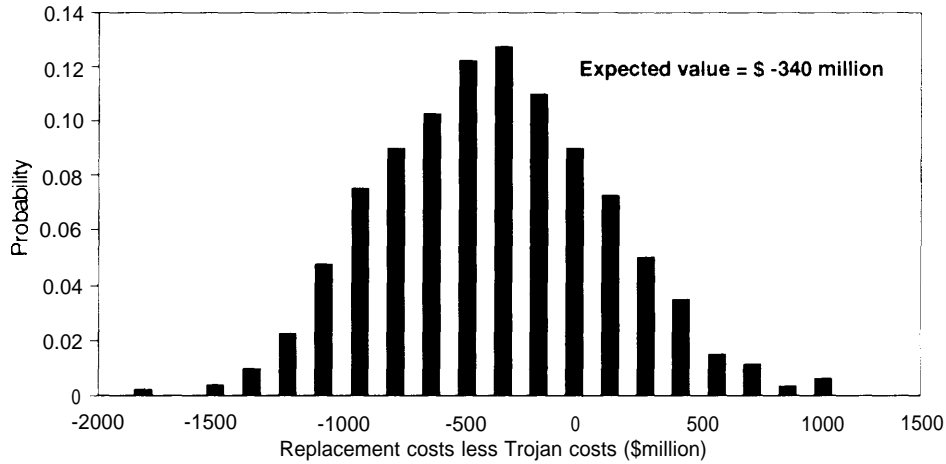
<sup>49</sup> Energy Policy Act of 1992, Public Law 102-486, Sec. 111. See also, U.S. Congress, Office of Technology Assessment, *Energy Efficiency: Challenges and Opportunities for Electric Utilities*, forthcoming.

<sup>50</sup> Portland General Electric, 1992 Integrated Resource Plan, Nov. 13/1992.

<sup>51</sup> See, for example, Niagara Mohawk, "Economic Analysis of Continued Operation of the Nine Mile Point Unit 1 Nuclear Station," Nov. 20, 1992.

<sup>52</sup> The expected value of continued operation was a loss of \$340 million in 1992 dollars, based on the estimated probabilities of different scenarios. Portland General Electric, 1992 Integrated Resource Plan Nov. 13, 1992, p. 4A.5.

Figure 3-6-Trojan Plant Economic Analysis Results



SOURCE: Portland General Electric, 1992 *Integrated Resource Plan*, Nov. 13, 1992.

gested that certain past State regulatory activities leading to plant retirement reflected an antinuclear bias rather than solid economic analysis. For example, commenting on IRP, one industry leader argued that “the process is subject to abuse, and extremely sensitive to bias, and that the economic analyses for SONGS-1 and Trojan plants were manipulated to retire these plants.<sup>53</sup> Though any planning process involving the complex and uncertain factors found in the utility industry is subject to manipulation, past economic decisions provide no compelling evidence of regulatory bias. In the Trojan case, for example, the utility itself determined that early retirement was the best option. In the SONGS-1 case, the owning utility argued that continued operation would be economic, but declined to pursue a proposal to place the risks and rewards of plant costs and performance on the utility.

### ■ Treatment of Unrecovered Capital in Early Retirement

There is limited precedence in the economic regulation of the electric industry to guide the

financial treatment of capital invested, but not yet recovered in rates, following the early retirement of a plant. Similarly, there is little precedent for the treatment of shortfalls in decommissioning funds resulting from early retirement. This is true for FERC as well as State regulation. For example, the only precedence for treatment of costs for the retired Yankee Rowe plant were two 1988 decisions for plant abandonment. However, those were plants canceled during construction, not abandoned operating plants.<sup>54</sup> Of the six recent early retirement decisions, unrecovered capital and decommissioning costs ranged from a few hundred million dollars for most to over \$4 billion for one. Allowing a utility to recover its capital costs in an early retirement is consistent with the traditional regulatory approach in which the prudence of the plant investment is determined when the plant becomes operational. However, in those retirement cases where plant performance was poorer and costs were substantially higher than originally anticipated, State PUCs may consider whether the utility performed adequately

<sup>53</sup> Phillip Bayne, “Nuclear Power in 1992: A Year-End Review,” remarks to *The Energy Daily’s* Annual Utility Conference, Dec. 10, 1992.

<sup>54</sup> “FERC Okays Yankee Rate Hike But Eyes ‘Prudence’ of Shutdown,” *Nucleonics Week*, vol. 33, No. 37, Aug. 6, 1992, pp. 4-5.

during the operating life of the plant and whether some cost disallowances are warranted.

Anticipated regulatory **treatment of decommissioning and historical plant costs can weigh in the economic attractiveness** to a utility of early retirement. As with the application of IRP, some have argued that State regulators' treatment of capital recovery in early retirement decisions for the SONGS-1 and Trojan plants were intended to "encourage their acquiescence."<sup>55</sup> SONGS-1 was retired in 1993 after 26 years of operation under an agreement between the California Public Utilities Commission (CPUC) Division of Ratepayer Advocates (DRA) and the owners of the unit (Southern California Edison (SCE) and San Diego Gas and Electric Co.). The agreement provided the utilities full recovery of the remaining \$460 million in capital costs over an accelerated 4-year period rather than the remaining 15 years in the licensed life. In addition, about \$29 million that had been excluded from the utilities' rate bases pending further review was returned to the utilities.<sup>56</sup> The utilities' rates of return on the \$460 million during the 4-year recovery, however, was reduced from 12 percent to 8 percent.

Not all commissions have allowed recovery of historical capital costs in early retirement decisions. Public Service of Colorado's (PSCO) Fort St. Vrain (FSV) plant is a case in point. The unit was built with about \$1 billion in joint funding

from PSCO, the Atomic Energy Commission, and General Atomics Technologies. After beginning commercial operation in 1979, the unique high-temperature gas reactor experienced major operational difficulties, including problems with the control rod drive assemblies and the steam generator ring headers, low plant availability (about 15 percent), and prohibitive fuel costs.<sup>57</sup> In 1986, PSCO, the Colorado Public Utilities Commission, the Colorado Office of the Consumer Counsel, and other parties agreed to remove FSV's \$600 million remaining capital costs from the utility's rate base.<sup>58</sup> However, the plant continued to operate under a performance incentive rate, giving PSCO both the risks of poor performance and the rewards of good performance. With FSV's economic problems continuing, PSC retired the plant in 1989.<sup>59</sup>

## ■ Other Economic Regulatory Incentives

Many States have established direct economic incentives for plant performance. As of 1989, about 70 nuclear plants operated under some type of explicit economic incentive program.<sup>60</sup> These incentives typically use specific formulas to measure management efficiency and plant performance and relate those to financial rewards or penalties. Most incentive programs use capacity factors (CFs)<sup>61</sup> as the primary measure of performance, although other measures are also found,

<sup>55</sup> P. Bayne, "Nuclear Power in 1992: A Year-End Review," remarks to *The Energy Daily's Annual Utility Conference*, Dec. 10, 1992.

<sup>56</sup> California PUC, Decision 92-08-036, Aug. 11, 1992, p. 3.

<sup>57</sup> Public Service Company of Colorado, Proposed *Decommissioning Plan for the Fort St. Vrain Nuclear Generating Station*, Nov. 5, 1990, pp. 1.1-1 to 1.1-2.

<sup>58</sup> Unrecovered capital costs included original construction costs of \$200 million and later capital additions of \$400 million. OTA staff conversations with Colorado Public Utility Commission staff, Aug. 25, and Sept. 24, 1992.

<sup>59</sup> In particular, due to FSV's unique nature (i.e., the only commercial gas reactor), the fuel costs were substantial. The cost of fuel in 1989 would have been approximately 2.8 cents per kWh. At the same time, PSC could generate coal-fired power for 2.7 cents per kWh and could purchase power for only 2.2 cents per kWh. Donald Warembourg, Site Manager, Fort St. Vrain Nuclear Station, Public Service Company of Colorado, personal communication, Sept. 23, 1992.

<sup>60</sup> R.L. Martin, P. Hendrickson and J. Olson, *Incentive Regulation of Nuclear power Plants by State Public Utility Commissions*, NUREG/CR-5509 (Washington, DC: U.S. Nuclear Regulatory Commission, December 1989). NRC tracks State economic incentive programs to evaluate their potential impact on safety.

<sup>61</sup> Capacity factor is a measure of a plant's actual production of electricity as a percentage of maximum possible production and is defined as the ratio of the electricity produced to the rated capacity of the facility.

such as the heat rate (the plant's thermal efficiency), NRC's Systematic Assessment of Licensee Performance (SALP) scores, and NRC performance indicators. Incentives for improving plant operating cost are not limited to nuclear power plants. For example, incentive based ratemaking has been included in decisions for non-nuclear activities Columbus Southern Power in Ohio.<sup>62</sup>

Incentive programs have generally involved relatively small dollar values relative to total plant costs. Many of the incentive programs had awarded no penalties or rewards during the several-year period reviewed in one NRC report.<sup>63</sup> The largest penalty reported was a 2-year cumulative \$32-million penalty for Public Service Electric and Gas (PSE&G) resulting from an extended forced outage at the two Peach Bottom units, of which PSE&G owns 42 percent.<sup>64</sup> In comparison, during that 2-year period, PSE&G's share of O&M costs for the two plants was far larger, over \$200 million.<sup>65</sup>

In contrast, PG&E's Diablo Canyon Units 1 and 2 have a performance-based rate designed to place the risks and rewards for plant performance on the utility rather than on the ratepayers.<sup>66</sup> The unconventional rate established by the CPUC in 1988 allows PG&E to receive payments based on actual plant output rather than on plant construction and operational costs. Since the rate was established, the plants have performed far more reliably than had been assumed in the CPUC's

and PG&E's analyses. Average CFs, at about 83 percent, have surpassed the assumed 58 percent, and payments to PG&E between 1989 and 1991 were about \$4.1 billion, or about 40-percent higher than the \$2.9 billion originally anticipated.<sup>67</sup> The performance-based rate approach results in plant economic life decisions being made more independently by PG&E and less in conjunction with the CPUC.

The performance-based approach has been suggested for other nuclear plants but not adopted to date. For example, as an alternative to SONGS-1 early retirement, the DRA proposed establishing a performance-based ratemaking treatment of future costs.<sup>68</sup> Noting that SCE did not pursue the proposal, the CPUC found that it "would be novel and complex, might create perverse incentives, and would require much time to work out."<sup>69</sup> Similarly, in 1989 Consumers Power Co. proposed selling its Palisades plant to a new entity, the Palisades Generating Co. (PGC), to be owned by Consumers Power, the Bechtel Power Corp., and a Westinghouse Electric Corp. subsidiary.<sup>70</sup> Prior to 1989, the Palisades plant performance had been well below the industry average, with problematic steam generators (SGs) leading to a lifetime CF of 48 percent. PGC would have sold its power to Consumers Power under a long-term purchase contract and accepted the risks and rewards of plant cost and performance. However, FERC and the State of Michigan

<sup>62</sup> "Ohio PUC to Consider Incentive Ratemaking for O&M Activities," *Electric Utility Week*, Sept. 21, 1992, pp. 16-17.

<sup>63</sup> R. L. Martin, P. Hendrickson and J. Olson, *Incentive Regulation of Nuclear Power Plants by State Public Utility Commissions*, NUREG/CR-5509 (Washington DC: U.S. Nuclear Regulatory Commission, December 1989).

<sup>64</sup> U.S. Nuclear Regulatory Commission, *Owners of Nuclear power Plants*, NUREG-0327; Rev. 5. (Washington, DC: July 1991), p. 6.

<sup>65</sup> U.S. Department of Energy, Energy Information Administration, *An Analysis of Nuclear Plant Operating Costs: A 1991 Update*, DOE/EIA-0547 (Washington, DC: May 1991), p. 59.

<sup>66</sup> California Public Utilities Commission, Decision 88-12-083, at 282.

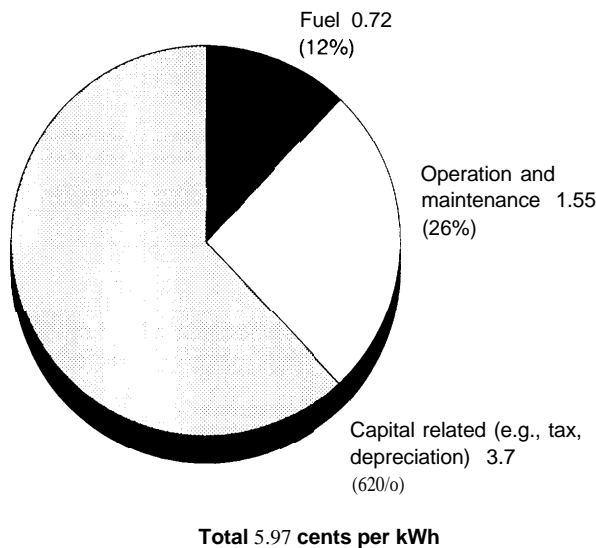
<sup>67</sup> Toward Utility Rate Normalization, "Petition of Toward Utility Rate Normalization for Modification of Decision 88-12 -083," Sept. 17, 1992, pp. 7-11.

<sup>68</sup> California Public Utilities Commission Division of Ratepayer Advocates, "Report on the Cost-Effectiveness of Continued Operation of the SONGS Unit No. 1," Investigation 89-074X)4, Sept. 25, 1991, pp. 45-52.

<sup>69</sup> California Public Utilities Commission Decision 92-08-036, Aug. 11, 1992, p. 23.

<sup>70</sup> Federal Energy Regulatory Commission "Initial Decision on Applications for Approval of a power purchase Agreement and the Sale of Certain Transmission Facilities," 59 FERC 63,023, June 17, 1992.

**Figure 3-7—Average Nuclear Power Plant Costs, 1990**



SOURCE: U.S. Department of Energy, Energy Information Administration, *Electric Plant Cost and Power Production Expenses 1990*, DOE/EIA-0455(90) (Washington, DC: June 1992), p. 14.

decided the details of the proposed transfer and purchase power arrangements were not in the public interest.<sup>71</sup> Among the concerns, the proposed purchase power rates were found to be excessive, having been based on an assumed 55-percent CF, far lower than the average 74 percent produced in 1991 and 1992 following the replacement of the plant's SGs.

## ECONOMIC PERFORMANCE OF NUCLEAR PLANTS

Each nuclear power plant has **its own** unique history of cost and performance **that** differs from industry averages. Large year-to-year **fluctuations** in costs are common for most nuclear plants as capital additions are undertaken and completed. Plant availability also varies from year to year as the plants undergo refueling and planned

maintenance during 12- to 24-month refueling cycles. Also, unplanned repair outages contribute to cost and performance fluctuations.

Economic life decisions are plant specific. In evaluating the future economic prospects of any plant, the owners focus on the unique circumstances of that plant—its cost and performance, and the demand for, and value of, electricity in the region. While broad industry trends **may be** helpful in projecting future cost and performance of any particular plant, they do not determine the cost-effectiveness of a plant.

Three types of nuclear power plant costs can have important and distinct roles in determining the economic life of individual units:

1. historical capital costs,
2. future capital additions, and
3. annual O&M and fuel costs.

Capital-related costs in the United States on average are the largest component of total nuclear power plant costs, about 60 percent higher than O&M and fuel costs combined (see figure 3-7).<sup>72</sup> Together **with the** plant's CF, these costs characterize a plant's economic performance.

## ■ Plant Capacity Factors

Reliability and availability are important factors in nuclear plant life decisions. A plant's CF has a large impact on plant economy, since as more electricity is produced (i.e., as the CF rises) fixed costs are spread over more kilowatt-hours, reducing the average cost. In the case of SONGS-1, Trojan, Rancho Seco, and FSV, CFs well below the industry average contributed to early retirement decisions. For example, SONGS-1 had a **lifetime** CF of about 56 percent, and the 5-year average prior to the retirement decision was only 44 percent. The lifetime CFs for Trojan and FSV were about 55 and 15 percent, respectively.

<sup>71</sup> Ibid.; and Michigan Public Service Commission, Opinion and Order, Case Nos. U-9507 and U-9794, June 12, 1992.

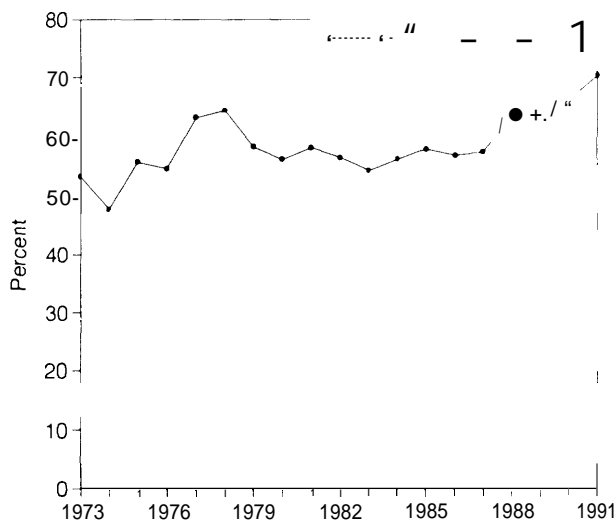
<sup>72</sup> U.S. Department of Energy, Energy Information Administration, *Electric Plant Cost and Power Production Expenses 1990*, EIA-0455(90) (Washington DC: June 1992), p. 14.

Future CFs at any plant are uncertain and thus subject to disagreement in economic analyses. For example, based on its analyses of other plants and effects of planned and completed maintenance activities, SCE suggested that reasonable CF scenarios for SONGS-1 ranged from 60 to 80 percent. In contrast, the DRA considered a range of 44 to 70 percent more likely based on its assessment of other plants and prospects.<sup>73</sup> Similarly PGE considered CFs ranging from 0 percent to over 80 percent in its analyses of Trojan, with an expected value of about 60 to 64 percent, depending on the replacement of SGs.

Average CFs at U.S. nuclear facilities have increased substantially in the past few years from an historical average of under 60 percent to over 70 percent in 1991 (see figure 3-8).<sup>74</sup> INPO has set an industry-wide median CF goal of 80 percent by 1995, which it views as a challenging but achievable target.<sup>75</sup> Nuclear plants do not operate continuously for several reasons:

- to allow for refueling outages, which typically require several weeks at least once every 2 years;
- for planned plant maintenance and capital additions (discussed below), which are performed concurrently with refueling to the extent possible, but often involve additional time;
- for equipment failures causing unscheduled maintenance; and
- for other operational problems (e.g., if plant operators fail to pass annual NRC qualification tests).

**Figure 3-8-Average U.S. Nuclear Power Plant Capacity Factors, 1973-1991**



SOURCE: U. S. Department of Energy, Energy Information Administration, *Annual Energy Review 1991* DOE/EIA-0384(91) (Washington, DC: June 1992), p. 237.

The need to refuel and conduct maintenance every 1 to 2 years creates a practical limit to overall CFs of about 80 to 90 percent over a cycle.

One EIA analysis identified three factors that contributed to the lower CFs of the 1980s, including increased safety and regulatory requirements, degradation of major equipment, and management problems.<sup>76</sup> Many of the safety-related outages resulted from NRC's Three Mile Island (TMI) action plan,<sup>77</sup> involving shutdowns for plant modifications and safety audits. EIA noted one series of EPRI reports that estimated that NRC regulatory actions accounted for about

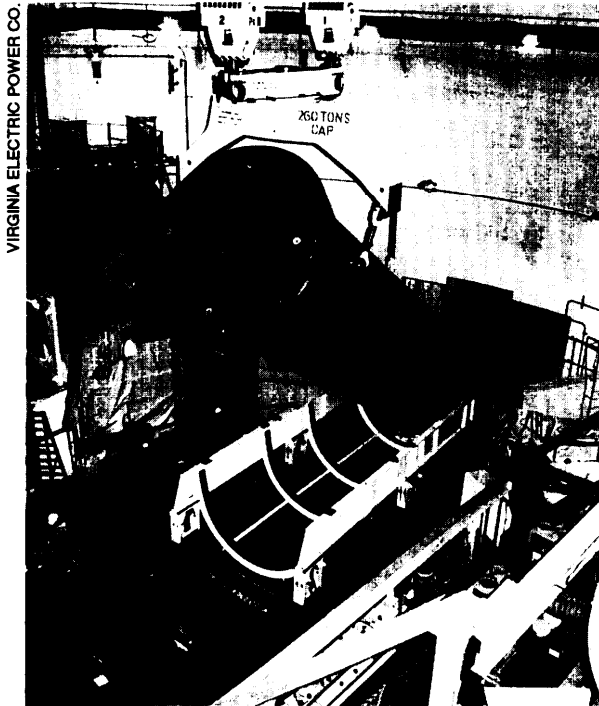
<sup>73</sup> California Public Utilities Commission, Division of Ratepayer Advocates, "Report on the Cost-Effectiveness of Continued Operation of the SONGS Unit No. 1," Investigation 89-07-004, Sept. 25, 1991, pp. 6-10.

<sup>74</sup> U.S. Department of Energy, Energy Information Administration, *Annual Energy Review 1991*, DOE/EIA-0384(91) (Washington, DC: June 1992), p. 237.

<sup>75</sup> Institute of Nuclear Power Operations, *1992 Performance Indicators for the U.S. Nuclear Utility Industry* (Atlanta, GA: March 1993).

<sup>76</sup> W. Liggett and K.C. Wade, "Improvements in Nuclear Power Plant Capacity Factors," *Electric Power Monthly*, DOE/EIA-0226(93/02) (Washington DC: U.S. Department of Energy, Energy Information Administration February 1993).

<sup>77</sup> U.S. Nuclear Regulatory Commission, *Clarification of the TMI Action Plan Requirements*, NUREG-0737, November 1980.



*Virginia Power completed its steam generator replacement project at the North Anna plant well under budget, with lower occupational exposures, and in less time than had been anticipated.*

10 percent reduction in CFs between 1980 and 1988.<sup>78</sup> Aging degradation of some major plant components such as recirculation pipes in boiling water reactors (BWRs) and SGs in pressurized water reactors (PWRs) have required a variety of maintenance activities including major equipment replacements that also reduced CFs. For example, steam generator replacement outages have generally required several months, although one recent experience at Virginia Power's North

Anna plant has reduced that time greatly.<sup>79</sup> In addition, improved water chemistry and better materials used for major component replacements have reduced equipment degradation rates and the resulting outage times.

Finally, EIA noted that management problems in some plants led to poor CFs in the 1980s, a problem mitigated by INPO and EPRI industry-wide efforts to promote the best practices in use. Still, while industry averages have clearly improved, a wide diversity in the range of plant CFs remains (see figure 3-9). For the 96 plants operating during the 3-year period 1989-1991,<sup>80</sup> 27 plants had a CF above 80 percent, while 13 had below 50 percent, with an average of 67 percent.<sup>81</sup> In comparison, one-third of the 61 plants between 1980 and 1982 had CFs below 50 percent, and 13 percent had CFs above 80 percent. Internationally, several countries with large numbers of nuclear plants have had higher average CFs than U.S. plants, while others have had lower CFs. For example, for the year ending June 1992, the average annual CF for Japan's 42 plants was 73 percent compared to 69 percent for the United States, and 63 percent for France's 55 units.<sup>82</sup>

## ■ Historical Capital Costs

Over half of the total generation expenses for U.S. nuclear plants is related to recovery of historical capital costs.<sup>83</sup> These historical capital costs include the initial construction costs and later capital additions (i.e., major nonrecurring repairs or retrofits performed to improve plant performance or meet safety requirements). As of 1990, the capital invested in operating nuclear

<sup>78</sup> Electric Power Research Institute, *Nuclear Unit Operating Experiment: 1980 through 1988, 1991*.

<sup>79</sup> "Virginia Power's North Anna-1 Unit Returned to Service in Record Time," *Electric Utility Week*, Apr. 19, 1993, pp. 6-7.

<sup>80</sup> Because year to year fluctuations are routine, a plant's COST and performance in any given year may differ greatly from its long-term record. For this reason, meaningful comparisons between the performance of different plants should consider multiple years.

<sup>81</sup> W. Liggett and K.C. Wade, "Improvements in Nuclear Power Plant Capacity Factors," *Electric Power Monthly* (Washington DC: U.S. Department of Energy, Energy Information Administration, February 1993).

<sup>82</sup> Nuclear Engineering International, *World Nuclear Industry Handbook 1993*, p. 18.

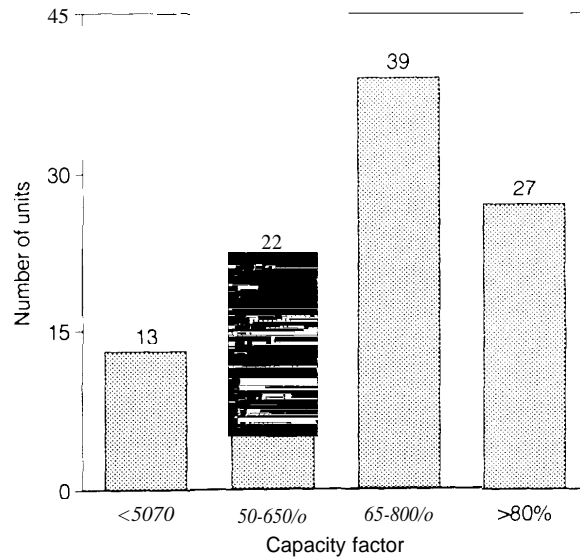
<sup>83</sup> U.S. Department of Energy, Energy Information Administration, *Electric Plant Cost and Power Production Expenses 1990*, EIA-0455(90), June 1992, p. 14.

power plants totaled over \$150 billion.<sup>84</sup> Utility investments in these historical capital costs are gradually recovered in utility rates over the life of the plant through depreciation and return on investment.

As utility costs increased in the 1980s, many State regulatory commissions scrutinized utility expenditures more closely, especially the often large construction cost escalations for nuclear plants. In some cases, regulators found that plants were unnecessarily expensive or that the generating capacity was not needed and did not allow the utility to recover the full costs from customers. These disallowances may have been justified, but may make utilities reluctant or unable to continue investing in existing plants, especially if high capital costs are involved. For example, a 1992 decision of the Illinois Commerce Commission (ICC) raised the prospect that much of CECO \$7.1 billion investment in the Byron 2 and Braidwood-1 and -2 plants were not “used and useful, and thus may not be recovered. As a result, CECO announced substantial cutbacks in capital investment and operating costs and was considering closing nuclear or fossil plants.<sup>85</sup>

Increasing competitive pressures in the electric power industry can also affect a utility’s ability to recover capital costs. For example, Public Service of New Mexico (PNM) took a \$127 million write-down for its 130-MW (10 percent) share of the Palo Verde unit 3 nuclear power plant in 1992.<sup>86</sup> According to PNM’s chairman, the write-down was a move towards “positioning the company for the inevitable open and competitive electric marketplace.”

**Figure 3-9-Range of Capacity Factors Over 3-Year Interval, 1989-1991**



SOURCE: W. Liggett and K.C. Wade, “Improvements in Nuclear Power Plant Capacity Factors,” *Electric Power Monthly* (Washington, DC: U.S. Department of Energy, Energy Information Administration, February 1 1993).

## ■ New Capital Additions

Capital additions are the plant upgrades that include repairs or replacement of major equipment (e.g., replacing SGs) and major plant modifications. Capital additions are generally distinguished from other maintenance costs in that they involve large expenditures on equipment expected to last many years. Capital additions may be needed to meet NRC safety requirements (e.g., seismic and fire control backfits), or utilities may perform them to maintain or improve plant economy, safety, or both. One study of four nuclear plants found that the portion of capital

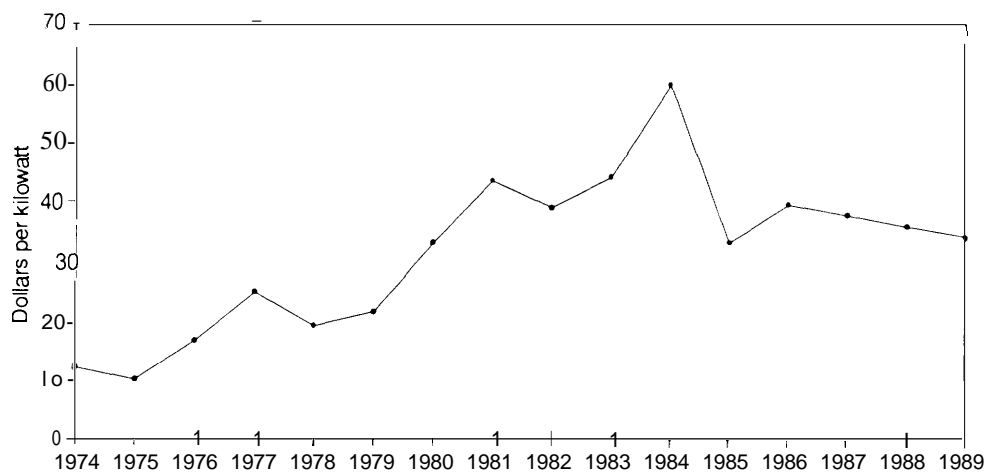
<sup>84</sup> Nominal dollars in year invested. U.S. Department of Energy, Energy Information Administration, *Financial Statistics of Selected Investor Owned Electric Utilities 1990*, DOE/EIA-0437(90)/1, January 1992, p. 40; U.S. Energy Information Administration, *Financial Statistics of Selected Publicly Owned Electric Utilities 1990*, DOE/EIA-0437(90)/2, February 1992, p. 15; and U.S. Department of Agriculture, Rural Electrification Administration, *1988 Statistical Report, Rural Electric Borrowers*, REA Bulletin Number 1-1, 1989.

<sup>85</sup> “Commonwealth Announces Cutbacks, Keeps Plant Closings Option Open,” *Nucleonics Week*, vol. 33, No. 31, July 30, 1992, pp. 1-2.

<sup>86</sup> “PNM Sets \$142.5-Million Write-Down Tied to Excess Generating Capacity,” *Electric Utility Week*, Feb. 8, 1993, pp. 9-10.



**Figure 3-10—Average Annual Nuclear Power Plant Capital Additions Costs 1974-1989  
(1991 dollars per kilowatt of capacity)**



SOURCE: Office of Technology Assessment, adapted from U.S. DOE, Energy Information Administration, *An Analysis of Nuclear Power Plant Operating Costs: A 1991 Update*, DOE/EIA-0547 (Washington, DC: May 1991).

additions costs attributable to NRC safety regulations varied between 34 percent and 65 percent.<sup>87</sup>

The large, one-time costs involved and the potential for long outages may make capital addition decisions de facto plant life decision points. For example, the economic analysis leading to the SONGS-1 early retirement decision was initiated because of the large capital additions request filed by the plant's owner.<sup>88</sup> Similarly, the need to replace the SGs at a cost of up to \$200 million weighed heavily in PGE's decision to retire the Trojan nuclear plant, along with the availability of lower cost electricity options.<sup>89</sup>

Historical average capital additions costs have varied greatly, hitting a peak in the mid-1980s (see figure 3-10).<sup>90</sup> Some capital additions have been required to mitigate aging degradation, for example, replacements of recirculation system

pipings in BWRs and SGs in PWRs. Other capital additions have been unrelated to aging, but resulted instead from deficiencies identified in plant design, such as the TMI and Browns Ferry fire protection backfits.<sup>91</sup> The variety and number of capital additions has been great. For example, table 3-1 shows the variety of major capital additions reported as construction work in progress in 1988. Although any particular capital addition is nonrecurring, most plants have experienced a series of different capital additions.

Because capital additions typically involve long-lived equipment changes, the costs are not recovered entirely in utility rates in the year they are expended but rather are recovered gradually over several years, as are construction costs. As a result, the expected remaining operating life of a plant can be an important factor in determining

<sup>87</sup> SC&A, Inc., "Analysis of the Role of Regulation in the Escalation of Capital Additions Costs for Nuclear Power Plants," ORNL/Sub/88-SC557/1 (Oak Ridge, TN: Oak Ridge National Laboratory, July 1989).

<sup>88</sup> California Public Utilities Commission Order 1.89-07-004

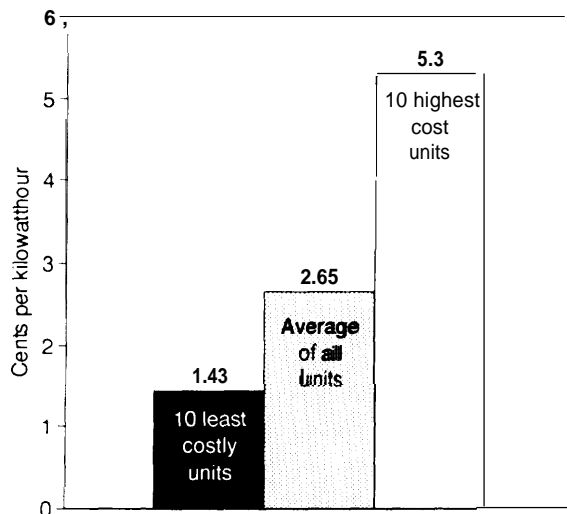
<sup>89</sup> Portland General Electric Co., *1992 Integrated Resource Plan*, Nov. 13, 1992.

<sup>90</sup> Capital additions costs are not explicitly reported to the Federal Government as plant-specific costs by utilities in their annual "FERC Form 1" filings, making it difficult to estimate them accurately. U.S. Department of Energy, Energy Information Administration, *An Analysis of Nuclear Plant Operating Costs: A 1991 Update*, DOE/EIA-0547 (Washington DC: May 1991).

<sup>91</sup> 10 CFR 50, app. R.



**Figure 3-12—Diversity in Nuclear Plant Fuel and Operating and Maintenance Costs (3-year average cost, 1990-1992)**



SOURCE: "Wolf Creek Leads As U.S. Utilities Hone Nuclear Economic Performance," *Nucleonics Week*, vol. 34, no. 25, June 24, 1993, pp. 7-10.

over time. For example, the staffing level at the Ginna nuclear plant grew from 59 people in 1970 to approximately 600 in 1990.<sup>97</sup> Other factors include increasing safety and NRC regulatory requirements, economic incentives, and regional conditions, although much of the variation remains unexplained. In contrast to O&M, fuel costs have remained relatively stable in real terms over the past two decades.

Federal reporting requirements do not specifically address several important overhead costs, potentially leading to inaccurate assessments of

nuclear plant costs. Overhead costs include annual NRC operating license fees of about \$3 million per plant,<sup>98</sup> nuclear liability insurance, plant staff benefits, and other factors, many of which are uniquely or predominantly associated with nuclear plants.<sup>99</sup> These costs are typically reported by utilities in their annual "FERC Form 1" filings as company-wide costs rather than plant-specific costs and can be difficult to estimate accurately. In total, overhead costs represent a substantial portion of total operating costs, estimated in one analysis at about 30 percent of the reported O&M costs.<sup>100</sup> Although many published reports do not include these costs,<sup>101</sup> they are important to consider in economic decisions about plant life.

## FACTORS AFFECTING FUTURE COST AND PERFORMANCE

Several factors affecting nuclear plant cost and performance will likely play important roles in the future. These include:

- plant aging;
- competitive pressures;
- nuclear industry evolution, including new experience, technology, and NRC regulatory changes; and
- radioactive waste disposal.

In an analysis of nuclear production costs, EIA attempted to examine the key factors but found no analytical measure to differentiate the effects of NRC regulatory requirements from the effects of

<sup>97</sup> Nuclear Management and Resources Council, "Review of Operations and Maintenance Costs in the Nuclear Industry," NUMARC 92-03 (Washington DC: December 1992), p. 19.

<sup>98</sup> 10 CFR 171.15.

<sup>99</sup> H.I. Bowers, L.C. Fuller, and M.L. Myers, *Cost Estimating Relationships for Nuclear Power Plant Operation and Maintenance*, ORNL/TM-10563 (Oak Ridge, TN: Oak Ridge National Laboratory, November 1987).

<sup>100</sup> Ibid.

<sup>101</sup> See for example, U.S. DOE, Energy Information Administration, *Electric Plant Cost and Power Production Expenses 1990*, DOE/EIA-0455(90), June 1992, table 14, "Average Production Expenses for Nuclear Steam-Electric Plants Owned by Major Investor-Owned Electric Utilities, 1985-1990;" U.S. DOE, Energy Information Administration, *An Analysis of Nuclear Plant Operating Costs: A 1991 Update*, DOE/EIA-0547, May 1991, p. 5.; and Jim Clarke, "Nuclear O&M Costs Sliding Downward, UDI Says," *The Energy Daily*, vol. 20, No. 127, July 2, 1992, p. 1.

new technology and information.<sup>102</sup> Further, the analysis lacked information to distinguish between safety-related activities that a utility would have and have not undertaken on its own absent NRC requirements. Similarly, no method was found to distinguish between plant aging (which should increase costs) and utility experience (which could either increase or decrease costs). Some general attributes of the factors affecting cost and performance are noted below.

### ■ Effects of Age on Cost and Performance

Plant maintenance to address aging degradation involves a variety of monitoring, evaluation, repair, and replacement activities. Some of these activities involve major capital additions, which may be very costly and could prove to be plant life decision points. Utilities are increasingly developing life-cycle management approaches to coordinate long-term capital planning and mitigate aging degradation for major systems, structures, and components (SSCs).<sup>103</sup> Although expensive, some aging management activities may actually lead to improved economic performance. For example, addressing aging involves improving maintenance programs generally, allowing for preventive or reliability centered maintenance rather than corrective maintenance. The result of applying a preventive maintenance program can be both lower costs and improved availability.<sup>104</sup> Plant experience may improve performance with age as well. This factor, however, is difficult to

distinguish from other age-related effects on operational and capital additions costs.

Given the lack of experience with large nuclear plants beyond the middle of their 40 year licensed lives, available evidence to predict accurately the long term effects of aging on economic performance is limited but continues to evolve.<sup>105</sup> As of 1992, only 21 plants were 20 years or older. Those plants are smaller than the younger units, with an average capacity of 616 MW compared to 974 MW.<sup>106</sup> The evolving experience and research is particularly important for those relatively few, but often major, SSCs intended to last the life of a plant (e.g., the reactor pressure vessel, the containment structure).

EIA's analysis of operational costs for existing plants (which, for the study period, had attained an average age of only 13 years) suggests that over the first third of a plant's assumed design life, the beneficial effects of increasing experience outweighed aging degradation effects, and costs decline with increasing age.<sup>107</sup> However, capital additions costs appeared to increase with age for BWR plants.

The costs of addressing aging degradation have played a role in each of the three early retirement decisions announced in 1992. For the SONGS-1 and Trojan plants, steam generator deterioration were primary aging issues, while the costs to resolve a pressure vessel embrittlement issue contributed to Yankee Rowe's closure.

<sup>102</sup> U.S. Department of Energy, **Energy Information Administration**, *An Analysis of Nuclear Plant Operating Costs: A 1991 Update*, DOE/EIA-0547 (Washington, DC: May 1991).

<sup>103</sup> See, e.g., Grove Engineering, Inc., *Long-Term Capital Planning Considering Nuclear Plant Life-Cycle Management*, EPRI TR-101162 (Palo Alto, CA: Electric Power Research Institute, September 1992); and Stone and Webster Engineering Corp. and Baltimore Gas and Electric Co., *Service (Salt) Water System Life-Cycle Management Evaluation*, EPRI TR-102204 (Palo Alto, CA: Electric Power Research Institute, April 1993).

<sup>104</sup> Northern States Power Company, *BWR Pilot Plant Life Extension Study at the Monticello Plant: Interim Phase 2*, EPRI NP-5836M (Palo Alto, CA: Electric Power Research Institute, October 1988).

<sup>105</sup> J.G. Hewlett, "The operating Costs and Longevity of Nuclear Power Plants," *Energy Policy*, July 1992, pp. 608-622.

<sup>106</sup> U.S. Department of Energy, *Nuclear Reactors Built, Being Built, or planned: 1991*, DOE/OSTI-8200-R55 (Washington, DC: July 1992), pp. ix-xiv.

<sup>107</sup> U.S. Department of Energy, **Energy Information Administration**, *An Analysis of Nuclear Plant Operating Costs: A 1991 Update*, DOE/EIA-0547 (Washington, DC: May 1991), p. 9.

## ■ Competitive and Regulatory Pressures for Improved Cost and Performance

The past years' early retirements and increased attention to the prospect of retirements at other plants have heightened the awareness that poor plant economic performance may have serious consequences. Increasing State regulatory attention to plant life issues as part of IRP efforts and intensifying competition in the electric power market may be powerful motivators for improving nuclear plant costs and performance. One indication of growing industry attention is the development of the Industrywide Initiative noted earlier to improve plant economic performance. The resulting rate of adoption of new cost- and performance-improving measures, and the overall effect on nuclear plant competitiveness, remains to be seen.

Recent efforts by several utilities to reduce nuclear plant staffing, a primary component of plant O&M, provide an example of a growing effort to control costs.<sup>108</sup> Since 1992, several utilities have announced efforts to reduce nuclear-related personnel. For example, Philadelphia Electric Co., operator of four nuclear plants (Peach Bottom units 2 and 3 and Limerick units 1 and 2) announced plans to reduce 635 of 3,400 nuclear operations positions by 1995 for an expected savings of about \$35 million to \$38 million annually.<sup>109</sup> Similarly, Niagara Mohawk has announced its consideration of cost cutting moves to reduce its 2,000-person nuclear division staff by 20 percent as part of an effort to reduce O&M costs in order to keep operating.<sup>110</sup> The Washington Public Power Supply System also

announced plans to reduce its nuclear plant work force of 1,400 by 300.<sup>111</sup>

The industry continues to develop new technologies with the prospect of improving nuclear plant economic performance. Among them are a variety of maintenance approaches including advanced decontamination techniques, reducing worker exposures and thus labor costs (see box 3-A); remote surveillance and robotics that allow monitoring and repair of equipment in previously inaccessible or expensive to work in areas; predictive maintenance practices that allow for better planning of maintenance activities (see ch. 2).

The experience of Virginia Power in replacing the SGs at its North Anna-1 plant is one example of how increased experience may aid in controlling costs. That effort took a far shorter time than planned and typically found in previous SG replacement projects (51 days rather than the planned 150 days); cost substantially less (\$130 million rather than the \$185 million planned); and resulted in far lower occupational exposures (240 person-rem rather than the 480 predicted).<sup>112</sup> Virginia Power noted that the much better than expected effort resulted from previous experience with Surry 1 and 2, careful advance planning, attention to detail, and support from the project engineer, Bechtel Corp. Not all major projects may be so fortunate, however. For example, steam generator replacement for Millstone unit 2, completed in January 1993 and projected to cost \$190 million, took 228 days, 93 more than planned.

<sup>108</sup> Utility cost control efforts are not restricted to nuclear plants. Many utilities are reducing non-nuclear staffing, as well, as part of their efforts to meet growing electric industry competition. See, e.g., "Redeployment to Cut PSE&G Jobs by 500—4% of Total-by Early '94," *Electric Utility Week*, Apr. 19, 1993, p. 3; and "PG&E to Freeze Rates Through 1994, Cut Industrial Rates \$100-Million," *Electric Utility Week*, Apr. 19, 1993, p. 17.

<sup>109</sup> *Electric Utility Week*, Nov. 30, 1992, p. 6; and *Nucleonics Week*, Apr. 22, 1993, p. 4-5.

<sup>110</sup> "NiMo's Cost-Cutting Results in 1,400 Lost Jobs," *Electric Utility Week*, Feb. 8, 1993.

<sup>111</sup> Harriet King, "Northwest Nuclear Plant's New Strategy," *New York Times*, June 9, 1993, p. D-3.

<sup>112</sup> "Virginia Power Sets World Record for Steam Generator Replacement" *Nucleonics Week*, Apr. 15, 1993, pp. 1,11-12.

### Box 3-A—Chemical Decontamination

In performing analyses to determine cost-effective occupational radiation exposure reductions, the industry typically uses a value of \$10,000 per man-rem.<sup>1</sup> Chemical decontamination techniques represent an increasingly common method to reduce occupational radiation exposures and, thereby, operational costs at existing commercial nuclear power plants.<sup>2</sup> Decontamination—such as manual scrubbing or washing with chemical agents—removes radiologically contaminated materials created in the pressure vessel that have dispersed and settled throughout a steam supply system by the circulation of cooling water.

Experience with chemical decontamination at operating reactors has increased substantially in the last decade, particularly with the development of softer (i.e., less extreme pH ranges), more dilute solutions that cause less wear (e.g., corrosion, pitting, intergranular attack) on plant materials and systems.<sup>3</sup> Early experience with concentrated chemical decontaminants produced high levels of decontamination. However, because of the attendant problems of corrosion damage and waste disposal, concentrated processes will probably not be applied to operating reactors again. A variety of dilute chemical decontaminants can achieve comparable decontamination, but application times vary, which is a more important consideration for operating reactors than retired ones, because of the relatively higher costs for extended down times.

Most applications have been on boiling water reactors (BWRs), particularly as part of pipe maintenance efforts. For BWR applications, 66 to 75 percent of the contaminant radioactivity and corrosion products have been removed in the first chelating step.<sup>4</sup> Although greater levels of decontamination are possible with multiple washings, waste volumes increase with each washing step and, with some recirculating processes, the potential for recontamination increases.

Opportunities exist to make chemical decontamination potentially more effective. Although at least 60 commercial nuclear plant systems at more than 20 reactors have been chemically decontaminated using dilute solutions, no plant has attempted decontamination of the entire reactor coolant system. Consolidated Edison (Con Ed) has proposed demonstrating a full system decontamination (FSD) at its Indian Point unit 2 plant.<sup>5</sup> Con Ed estimates that FSD can reduce radiation fields by a factor of at least five, saving 3,500 man-rems (with an estimated value of \$35 million) over the nearly 20 years remaining in the life of the plant.<sup>6</sup>

<sup>1</sup> Consolidated Edison, "Abstract: National Demonstration of Full RCS Chemical Decontamination," 1992.

<sup>2</sup> J.F. Remark, Applied Radiological Control, Inc., *A Review of Plant Decontamination Methods: 1988 Update*, EPRI NP-6169 (Palo Alto, CA: Electric Power Research Institute, January 1989), p. 2-9.

<sup>3</sup> C.J. Wood and C.N. Spalaris, *Sourcebook for Chemical Decontamination of Nuclear Power Plants*, EPRI NP-6433 (Palo Alto, CA: Electric Power Research Institute, August 1989), pp. 1-1, 1-4, 2-1.

<sup>4</sup> J.F. Remark, Applied Radiological Control, Inc., *A Review of Plant Decontamination Methods: 1988 Update*, EPRI NP-6169 (Palo Alto, CA: Electric Power Research Institute, January 1989), pp. 2-1 to 2-3, 2-8 to 2-9; C.J. Wood and C.N. Spalaris, *Sourcebook for Chemical Decontamination of Nuclear Power Plants*, EPRI NP-6433 (Palo Alto, CA: Electric Power Research Institute, August 1989), p. 2-8.

<sup>5</sup> J.B. Mason et al., *Full Reactor Coolant System Chemical Decontamination at Consolidated Edison Indian Point-2 Plant*, Pacific Nuclear Services, November 1991.

<sup>6</sup> Consolidated Edison, "Abstract: National Demonstration of Full RCS Chemical Decontamination," 1992.

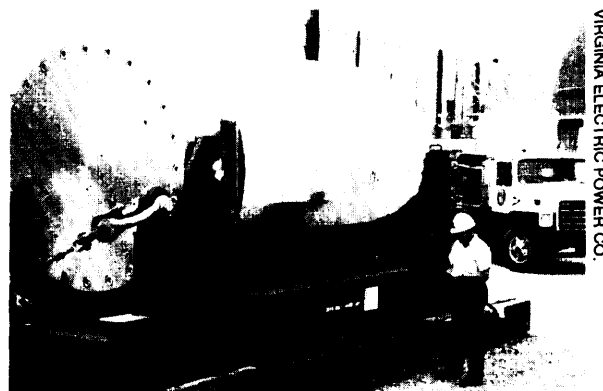
## ■ Evolving NRC Activities

Since its creation in 1974, the NRC has often revised regulatory requirements with the goal of assuring adequate safety. These requirements can result in increased operational and capital additions costs. However, to the extent that NRC requirements reflect new experience and information, at least some of these efforts could have been undertaken as part of industry safety efforts even absent NRC's mandates. In response to an NRC request,<sup>113</sup> NUMARC has identified several regulatory requirements that it believes result in increased costs without commensurate benefits to safety. One aspect of the Industrywide Initiative developed by the nuclear industry is to reduce overall costs while maintaining current safety levels as well as to focus on how to change the responses of nuclear utilities to regulatory activities.<sup>114</sup>

Assessing the extent to which future safety regulatory changes, including those related to managing aging, will affect costs at existing nuclear plants is necessarily speculative. As discussed in chapter 2, major aging-related regulatory activities currently include: final implementation of the maintenance and license renewal rules; elevation of fatigue and environmental qualification of electrical equipment to generic safety issues; and resolving how to demonstrate compliance with reactor pressure vessel embrittlement.

## ■ Radioactive Waste Disposal

Disposal of spent fuel and low-level waste (LLW) may present increasing future costs. In



*One of Virginia Power's dry storage casks for spent fuel.*

1991, spent fuel discharges from commercial nuclear power reactors totaled 1,915 metric tons. The total inventory of discharged commercial spent fuel (collected from 1968 to 1991) in the United States is 23,731 metric tons.<sup>115</sup> The total inventory is projected to increase to about 32,000 metric tons in 1995 and 42,000 metric tons by 2000.<sup>116</sup> Water-filled pools in the reactor building are used to cool and store spent fuel for at least 5 years. Under the Nuclear Waste Policy Act of 1982<sup>117</sup> (NWPA), the Federal Government is ultimately responsible for disposal of spent fuel, although progress to date has been limited (see box 3-B).

Inadequate spent fuel storage capacity, together with the lack of progress in DOE's programs, place both direct and indirect costs on existing nuclear power plants. According to data compiled from recent DOE surveys, 28 operating reactors, about 25 percent of all 107 U.S. plants, will have inadequate spent fuel storage capacity

<sup>113</sup> "Virginia Power Sets World Record for Steam Generator Replacement" *Nucleonics Week*, Apr. 15, 1993, pp. 1, 11-12.

<sup>114</sup> Nuclear Management and Resources Council, "Review of Operations and Maintenance Costs in the Nuclear Industry," NUMARC 92-03, December 1992, p. 55.

<sup>115</sup> U.S. Department of Energy, Energy Information Administration, *Spent Nuclear Fuel Discharges From U.S. Reactors 1991*, SR/CNEAF/93-01 (Washington, DC: February 1993), p. 21. Note: Tonnage figures reflect weight prior to irradiation a proxy measure of the final spent fuel weight.

<sup>116</sup> U.S. Department of Energy, Energy Information Administration, *World Nuclear Capacity and Fuel Cycle Requirements 1992*, DOE/EIA-0436(92) (Washington, DC: November 1992), pp. 13-14.

<sup>117</sup> Nuclear Waste Policy Act of 1982, Public Law 97-425, Jan. 7, 1983.

### Box 3-B--Federal Nuclear Waste Disposal Efforts

The Nuclear Waste Policy Act of 1982<sup>1</sup> (NWPAct) established the Office of Civilian Radioactive Waste Management within the U.S. Department of Energy (DOE) and directed the Secretary of Energy to open a repository for spent fuel by January 1998. To pay for this work, NWPAct established the Nuclear Waste Fund and set a fee of 0.1 cents per kilowatt-hour of electricity generated by commercial nuclear plants. As of September 1991, the Fund had collected nearly \$8 billion in fees and \$2 billion in interest, about \$3 billion of which had been spent.<sup>2</sup> However, the original 1998 target date for opening the repository will not be met. Under current plans, DOE expects to complete site characterization work at Yucca Mountain, the only location being investigated, by 2002.<sup>3</sup> DOE estimates that a geologic repository will be ready no sooner than 2010. In a report to Congress and the Secretary of Energy, however, the Nuclear Waste Technical Review Board concluded that even the 2010 schedule appears unrealistic.<sup>4</sup>

As an interim measure, DOE has claimed it would *open a* monitored retrievable storage (MRS) facility to accept spent fuel by 1998. As with a geologic repository, there are serious doubts about whether this will be available on schedule. In particular, the queue for the first 10 years of spent fuel transfers to an MRS has already been established through a DOE application process. The licensees that will deliver spent fuel, including the quantities and years of disposal, have already been selected.

Under current plans, DOE expects to accept 8,200 metric tons of spent fuel from 60 licensees (including itself) in the first 10 years after an MRS opens.<sup>5</sup> That represents less than 40 percent of the current commercial spent fuel inventory and only about 15 percent of the expected inventory by 2008, the soonest the transfers could be completed under the current schedule, assuming a 1998 start date.<sup>6</sup> Even with a 1998 start date, however, most of the vulnerable 28 units will have to have made other plans or face closure.

In 1992, DOE suggested building the MRS on Federal sites<sup>7</sup> together with development of integrated casks for shipping, storage, and disposal, but the ultimate public, congressional, State, and utility response to the proposal are not yet known. In fact, the recent legal challenges by the State of Idaho to halt shipments of spent fuel from the Fort St. Vrain reactor in Colorado to the Idaho National Engineering Laboratory (INEL) suggest that there can be serious resistance to the use of existing Federal sites for waste storage or disposal.

<sup>1</sup> Nuclear Waste Policy Act of 1982, Public Law 97-425.

<sup>2</sup> U.S. Department of Energy, Office of Civilian Radioactive Waste Management, *Annual Report to Congress: Office of Civilian Radioactive Waste Management*, DOE/RW-0335P (Washington, DC: March 1992), pp. 54, 65. In simple terms, a 1,000 MWe reactor operating at 80 percent capacity in a given year would be subject to roughly \$7 million in Nuclear Waste Fund fees.

<sup>3</sup> U.S. Department of Energy, Office of Civilian Radioactive Waste Management, *Progress Report on the Scientific Investigation Program for the Nevada Yucca Mountain Site, No. 6*, DOE/RW-0307P-6 (Washington, DC: September 1992), p. 1-2.

<sup>4</sup> Nuclear Waste Technical Review Board, *NWTRB Special Report*, (Arlington, VA: March 1993), p. v.

<sup>5</sup> U.S. Department of Energy, Office of Civilian Radioactive Waste Management, *Annual Capacity Report* @ DOE/RW-0331P (Washington, DC: December 1991), pp. v-vi, 9. A metric ton equals 2,204.6 pounds. Nuclear fuel weights are generally given in metric tons of initial heavy metal (MIHM), which refers to the original mass of the actinide fuel elements (mostly uranium).

<sup>6</sup> U.S. DOE projections of the total inventory of commercial spent fuel by 2008, assuming no new reactors are ordered, is 56,500 metric tons. U.S. Department of Energy, Energy Information Administration, *World Nuclear Capacity and Fuel Cycle Requirements 1992*, DOE/EIA-0436(92) (Washington, DC: November 1992), pp. 13-14.

<sup>7</sup> J.-S.D. Watkins, Secretary, U.S. Department of Energy, letter to J. Bennett Johnston, Chairman, Senate Committee on Energy and Natural Resources, Dec. 17, 1992, attachment, pp. 1-2.



**Table 3-2—Plants Projected to Require Additional Spent Fuel Storage Capacity by the Year 2000**

| Facility (State)            | Design capability | Loss of operability |
|-----------------------------|-------------------|---------------------|
|                             | (MW)              | (Year)              |
| Palisades (MI).....         | 755               | 1993                |
| Prairie Island 1 (MN), .... | 507               | 1995 <sup>118</sup> |
| Prairie island 2 (MN).....  | 503               | 1995 <sup>118</sup> |
| Calvert Cliffs 2 (MD).....  | 825               | 1996*               |
| Limerick 2 (PA).....        | 1,055             | 1996                |
| Nine Mile Point 1 (NY)....  | 605               | 1996                |
| Point Beach 1 (WI).....     | 495               | 1996                |
| Point Beach 2 (WI).....     | 495               | 1996                |
| Calvert Cliffs 1 (MD).....  | 825               | 1997 <sup>119</sup> |
| Peach Bottom 2 (PA).....    | 1,051             | 1998                |
| Waterford 3 (LA).....       | 1,075             | 1998                |
| Arkansas Nuclear 1 (AR) ..  | 836               | 1999                |
| Big Rock Point (MI).....    | 67                | 1999                |
| Dresden 2 (IL).....         | 772               | 1999                |
| Duane Arnold (IA).....      | 515               | 1999                |
| Ginna (NY).....             | 470               | 1999                |
| North Anna 1 (VA)....       | 911               | 1999                |
| North Anna 2 (VA)....       | 908               | 1999                |
| Peach Bottom 3 (PA)....     | 1,035             | 1999                |
| Robinson 2 (SC).....        | 683               | 1999 <sup>120</sup> |
| Washington Nuclear 2(WA).   | 1,100             | 1999                |
| Arkansas Nuclear 2 (AR) ..  | 858               | 2000                |
| Brunswick 1 (NC).....       | 767               | 2000                |
| Brunswick 2 (NC).....       | 754               | 2000                |
| Dresden 3 (IL).....         | 773               | 2000                |
| Maine Yankee (ME).....      | 870               | 2000                |
| Millstone 2 (CT).....       | 863               | 2000                |
| Oyster Creek (NJ).....      | 610               | 2000                |

NOTE: Units marked with an asterisk (\*) have constructed or announced plans to construct ISFSIs to increase their onsite spent fuel storage capacity. The projected closure years shown above, therefore, may no longer apply to some or all of these units.

SOURCE: U.S. Department of Energy, Energy Information Administration, *Spent Nuclear Fuel Discharges from U.S. Reactors 1991*, SR/CNEAF/93-01 (Washington, DC: February 1993), pp. 14-19.

under current plans by the end of the year 2000 (table 3-2).<sup>118</sup> Although measures such as reracking of spent fuel assemblies can extend the

capacity of fuel pools somewhat, the number of utilities that will have to construct independent spent fuel storage installations (ISFSIs) in order to continue operating is virtually certain to increase. Dry storage facilities have been or are planned to be constructed at several plants—both those still operating and those undergoing or planning decommissioning.

The direct costs of adding spent fuel storage capacity represent a small but not negligible percentage of other plant operational costs. For example, the Baltimore Gas and Electric Co., operator of the two Calvert Cliffs plants, has constructed an ISFSI for \$24 million, with annual operational costs of about \$1.5 million. The annualized cost represents less than 2 percent of Calvert Cliffs operating costs.

Some States have been reluctant to allow ISFSI siting, effectively representing a large indirect cost. In the extreme, lack of spent fuel storage threatens several operating plants with premature closure in the next several years. For example, Minnesota's Northern States Power operates the twin Prairie Island plants, which have operating licenses expiring in 2011 and 2013, but current storage capacity is sufficient only through 1995. Out of concern that a requested dry storage facility would become a de facto permanent repository, however, the Minnesota Public Service Commission limited the utility to constructing a facility that added only 7 more years of storage capacity.<sup>119</sup> A state court decision further restricted ISFSI use, ruling that the State legislature must approve any plans to store the fuel more than 8 years.<sup>120</sup> In Wisconsin, similar concerns are at

<sup>118</sup> U.S. Department of Energy, Energy Information Administration *Spent Nuclear Fuel Discharges from U.S. Reactors 1991*, SR/CNEAF/93-01 (Washington, DC: February 1993), table 4, pp. 14-19.

<sup>119</sup> "NSP Gets Reprieve From Minnesota PSC," *The Energy Daily*, vol. 20, No. 124, June 29, 1992, p. 1. See also *57 Federal Register* 34319 (Aug. 4, 1992).

<sup>120</sup> Minnesota law prohibits permanent fuel storage within the State. "Court Decision on Prairie Island Fuels Argument for Moving Waste," *Nucleonics Week*, vol. 34, No. 25, June 24, 1993, p. 17.

issue in the decision to continue operation or retire the Point Beach unit 2 nuclear plant.<sup>121</sup>

At present, the DOE is planning to construct a single national monitored retrievable storage (MRS) facility to store commercial spent fuel until a repository is available. Until that happens, however, an increasing number of de facto MRSs—in the form of dry cask storage installations built at reactor sites—will be necessary, both for many plants to continue operating after 2000 and for decommissioning to occur.

Beyond development of a repository, some treatment methods such as transmutation and

reprocessing for spent fuel are under development here and abroad but face major technical, economic, or political obstacles.<sup>122</sup>

LLW disposal costs have increased rapidly in the past and may continue to do so. However, LLW disposal costs during plant operation currently represent a fraction of 1 percent of the operational costs of nuclear plants. Even with the much higher disposal costs anticipated under the interstate compacts, LLW costs would average about 1 percent of operational costs. However, as discussed in chapter 4, there remain unmet challenges in developing LLW disposal facilities.

---

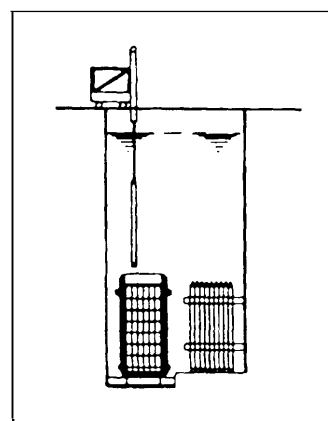
<sup>121</sup> The Point Beach unit 2 decision also involves consideration of a major capital expense, replacement of the plant's steam generators. *Nucleonics Week*, vol. 34, No. 25, June 24, 1993, p. 17.

<sup>122</sup> For more information on these and other spent fuel treatment options, see M. Holt and J.E. Mielke, *Civilian Radioactive Waste Management: Technical and Policy Issues*, 91-867 ENR (Washington DC: Congressional Research Service, Dec. 10, 1991); D. Gibson, "Can Alchemy Solve the Nuclear Waste Problem?" *The Bulletin of Atomic Scientists*, vol. 47, No. 6, July 1991, pp. 12-17; C. Newman, Rockwell International, *International Programs Related to the Transmutation of Transuranics*, EPRI NP-7265 (Palo Alto, CA: Electric Power Research Institute, April 1991); and M. Odell, "Vitrification-World Review," *Nuclear Engineering International*, vol. 37, No. 455, June 1992, pp. 51-53.

# Decommissioning Nuclear Power Plants | 4

**W**hen a nuclear plant is retired, decommissioning is performed to protect both public health and safety and the environment from accidental releases of remaining radioactivity. As defined by U.S. Nuclear Regulatory Commission (NRC) rules, decommissioning involves removing a reactor safely from service and reducing residual radioactivity to a level that allows a site to be released for unrestricted use, thereby allowing license termination.<sup>1</sup> Under NRC rules, decommissioning activities—such as plant decontamination, reactor dismantlement, and waste removal—can be performed within a few years or extended over many decades. Although current NRC rules favor the completion of decommissioning within 60 years after final plant shut down, the Commission will extend that period if necessary to protect public health and safety.<sup>2</sup> The lack of waste disposal capacity or the presence of other nuclear units on a site are two circumstances that could extend decommissioning periods beyond the current 60-year goal.<sup>3</sup>

Three general decommissioning approaches are recognized by nuclear professionals in the United States: DECON, SAFSTOR, and ENTOMB. The first approach, DECON, involves the immediate dismantlement of radioactively contaminated structures to a level allowing the site to be released for unrestricted use. SAFSTOR involves placing a nuclear plant into safe storage, followed years or decades later by sufficient decontamination and dismantlement to allow site release. The last approach, ENTOMB, involves partial dismantlement followed by the

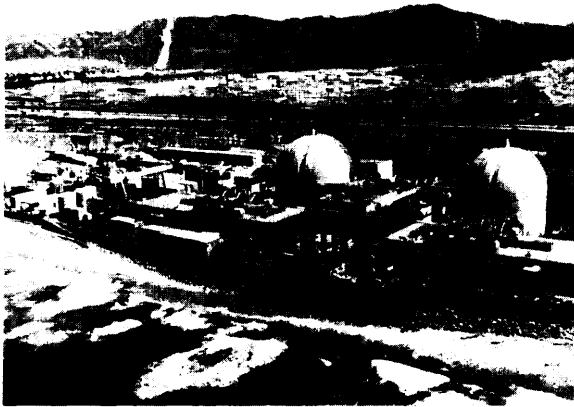


<sup>1</sup>10 CFR 30.4, 40.4, 50.2, 70.4, and 72.3.

<sup>2</sup>10 CFR 50.82 (b)(1)(i). If necessary to protect public health and safety, the U.S. Nuclear Regulatory Commission (NRC) will extend the allowable decommissioning period to about 100 years. 53 *Federal Register* 24023 (June 27, 1988).

<sup>3</sup>10 CFR 50.82 (a)(1) (iii).

SOUTHERN CALIFORNIA EDISON CO



*The oldest and smallest of the three units at the San Onofre Nuclear Generating Station (at the far left of the photo) was retired in 1992 after over 24 years of operation. The presence of the two remaining operating units is a factor considered in decommissioning planning for unit one.*

encasement of remaining radioactive contaminants in durable materials such as concrete and monitoring a site until sufficient radioactive decay has occurred to allow release for unrestricted use. The best approach will vary by plant and depend upon site-specific conditions, such as the level of radioactive contamination at shutdown, expected land uses, projected labor rates, waste disposal options and costs, and current and anticipated regulatory radioactivity standards.

Rather than technological adequacy, the major uncertainties associated with commercial nuclear power plant decommissioning **are the potential impacts of future residual radioactivity standards, limited and dwindling waste disposal options, and cost projections, the reliability of which will improve with the resolution of these other uncertainties.** While the technology exists to remove the radiological hazard at individual plant sites, residual radioactivity standards have not been promulgated by the NRC or the U.S. Environmental Protection Agency (EPA). In addition, States may impose nonradiological cleanup requirements at sites (e.g., site restoration) or perhaps additional radiological

requirements after NRC license termination. Moreover, the feasibility and costs of long-term radioactive waste storage and disposal remain unclear, both for low-level wastes (LLW) and spent nuclear fuel. These factors create major uncertainties in the anticipated schedules and projected costs of decommissioning commercial nuclear power reactors. With the recent retirement of several large operating reactors, this may be an opportune time to evaluate the national policies, regulatory standards, economics, public concerns, and other uncertainties (particularly waste disposal options) associated with commercial nuclear power plant decommissioning. For example, the 40-year operations period assumed for the collection of decommissioning funds has proven optimistic for several plants and may be optimistic for many others.

Although decommissioning costs are relatively small compared to total plant capital and operations expenses, prematurely retired plants may face significant decommissioning funding shortfalls, because they collected these funds for less time than expected. Although financially healthy utilities will generally be able to cover such shortfalls through increased electricity rates, insurance, credit, and other options, there are potentially serious intergenerational equity issues associated with collecting the bulk of decommissioning funds *after* plant closure. That is, based on current trends, future ratepayers may have to cover most of the costs of commercial nuclear power decommissioning without having received any of the electricity from a retired unit.

### **RESIDUAL RADIOACTIVITY STANDARDS: HOW CLEAN IS CLEAN ENOUGH?**

Residual radioactivity standards define the level of clean up necessary at sites undergoing decommissioning. Depending on their nature and stringency, such standards may have major impacts on decommissioning timing and costs, waste generation, occupational and public health

and safety, and the potential future uses of remediated sites.

Under current NRC decommissioning criteria, sites eligible for unrestricted use may contain some radioactivity above natural background levels—no more than 5 additional microrems ( $10^{-6}$  rems) of surface contamination per hour.<sup>4</sup> The NRC is currently developing a rule to establish residual radioactivity standards, and their ultimate nature and stringency could differ substantially from the current, less formal guidance, potentially altering the expected scope and costs of decommissioning. Possible residual radioactivity standards discussed during NRC public meetings held in 1993 ranged from doses of 0.03 to 60 millirems ( $10^{-3}$  rems) per year, a difference of three orders of magnitude. Based on the best available evidence (see ch. 2), these dose levels translate to lifetime cancer mortality risks ranging from one case per million to two cases per thousand exposed individuals, respectively.<sup>5</sup> Until final standards are promulgated, commercial power licensees and the public will remain uncertain about the residual health risks, cleanup costs, and other impacts of decommissioning nuclear power plants.

The practice of allowing low levels of residual radioactivity after facility closure occurs at many kinds of radiologically contaminated sites, including oil and natural gas drilling operations, nuclear and coal-fired electric power stations, and uranium and thorium mill tailing sites. Similar to other site remediation efforts, including those for containing hazardous chemicals, the potential risk at nuclear sites under current NRC decommissioning

criteria is reduced significantly but not eliminated entirely.

Internationally, residual radioactivity criteria are generally developed on a case-by-case basis and are commonly based on safety guidance published by the International Atomic Energy Agency (IAEA).<sup>6</sup> The IAEA guidance is risk-based, similar to existing NRC criteria, and finds that an individual exposure limit of several millirems per year from exempted materials represents a sufficiently small risk. To account for multiple exposure pathways (air, water, soil), the IAEA guidance recommends a limit of 1 millirem per year for each exempted practice. To date, most European nations have applied the principles of this IAEA guidance when setting residual radioactivity criteria for sites, but their major application has been in establishing recycling criteria for radiologically contaminated materials, not in decommissioning.<sup>7</sup>

The negative U.S. public and political reaction to the 1990 “below regulatory concern” (BRC) policy may indicate potential problems with the current NRC residual radioactivity criteria, as the NRC pursues a rulemaking to establish uniform remediation standards for decommissioning (box 4-A). Among other items, the 10 millirem annual exposure limit was a key element of the controversial policy, but current NRC decommissioning criteria of 5 microrem per hour above background would allow an unshielded individual present at the site 6 hours per day to receive roughly the same added annual exposure. In terms of cancer mortality, the best available evidence suggests that an annual exposure of 10 millirems translates

---

<sup>4</sup>This criterion applies to measurements made at 1 meter from the source, U.S. Nuclear Regulatory Commission, *Termination of Operating Licenses for Nuclear Reactors*, Regulatory Guide 1.86, June 1974, p. 5; and “Radiation Criteria for Release of the Dismantled Stanford Research Reactor to Unrestricted Access,” NRC letters to Stanford University, Mar. 17, 1981 and Apr. 21, 1982. For a discussion of these guidance documents, see U.S. Nuclear Regulatory Commission, Office of Nuclear Regulatory Research, *Final Generic Environmental Impact Statement on Decommissioning of Nuclear Facilities*, NUREG-0586 (Washington, DC: August 1988), p. 2-12.

<sup>5</sup>58 *Federal Register* 33573 (June 18, 1993).

<sup>6</sup>International Atomic Energy Agency, *Principles for the Exemption of Radiation Sources and Practices from Regulatory Control*, Safety Series No. 89 (Vienna, Austria: 1988).

<sup>7</sup>U.S. Nuclear Regulatory Commission “International Decommissioning Activities,” unpublished paper.

### Box 4-A-Residual Radioactivity Standards and the NRC Enhanced Participatory Rulemaking

An enhanced participatory rulemaking to develop residual radioactivity standards was first proposed by the U.S. Nuclear Regulatory Commission (NRC) in June 1991. While many rulemaking efforts solicit public input after a standard or guideline has been proposed, the NRC is using this process to solicit comments from affected parties in advance of a rule proposal. To enhance participation, the NRC held seven public meetings between January and May 1993 in different regions of the United States (Chicago, San Francisco, Boston, Dallas, Philadelphia Atlanta, and Washington, DC). The meetings provided a forum to hear **public concerns relating to residual radioactivity standards, including their nature and stringency. Under its current** schedule, the NRC expects to publish final residual radioactivity standards by May 1995.<sup>1</sup>

The rulemaking on residual radioactivity standards has emerged from failed attempts in the last several years to determine when either licensed materials or sites warranted no further regulatory attention due to sufficiently low levels of radioactivity. The history began with the passage of the Low-Level Radioactive Waste Policy Amendments Act of 1985 (P.L. 99-240; LLRWPA), which directed the NRC to determine a threshold of radioactivity in waste streams below which regulatory concern was not warranted.<sup>2</sup> In response to that legislation, the NRC published two below regulatory concern (BRC) policy statements (1986 and 1990). The 1986 statement outlined criteria and procedures for the expedited review of BRC petitions to exempt materials from the standard requirements for low-level waste management and disposal.<sup>3</sup> In 1990, the NRC published the second BRC policy statement that proposed individual dose criteria between 1 and 10 millirems (mrem) per year and a collective dose criterion of 1,000 person-rem per year.<sup>4</sup>

In establishing these BRC criteria—about 0.3 to 2.8 percent of current annual U.S. background exposure levels of 360 mrem—the NRC reasoned that the levels were comparable to levels of radiological risk normally accepted by the public (both voluntarily and involuntarily) from other activities (e.g., 5 mrem is a typical exposure for roundtrip flights between the east and west coasts of the United States). The NRC noted that far greater variability than 1 to 10 mrem occurs from natural background exposures in different U.S. regions, such as a difference of over 60 millirems for residents of Denver, Colorado compared to those of Washington, DC.<sup>5</sup>

<sup>1</sup> Francis Cameron, Office of the General Counsel, U.S. Nuclear Regulatory Commission, public statement during NRC participatory rulemaking meeting, Arlington, VA, May 6, 1993.

<sup>2</sup> Public Law 99-240, 99 Stat. 1859, Sec. 10(a).

<sup>3</sup> 51 Federal Register 30839 (Aug. 29, 1986).

<sup>4</sup> 55 Federal Register 27522 (July 3, 1990).

<sup>5</sup> 55 Federal Register 27526-27527 (July 3, 1990).

to an incremental annual risk of five cases per million individuals and a lifetime risk (assuming continuous exposure at that level) of about 4 cases per ten thousand.<sup>8</sup> Depending on the site, however, States, local authorities, and the public may have different expectations about acceptable levels of residual radioactivity and health risks. In

many cases, the levels of residual radioactivity implied by current NRC guidance maybe acceptable if site access and use are restricted. In other cases, State, local, or public concerns about future land uses at decommissioned sites may overshadow regulatory decisions over the selection of any quantitative radioactivity standards.

<sup>8</sup> 55 Federal Register 27527 (July 3, 1990).

Severe public and congressional reaction to the July 1990 BRC proposal prompted the NRC to place an indefinite moratorium on the policy statement shortly after it was issued. In particular, testimony delivered at congressional hearings held the same month the policy was issued indicated several **major concerns about the BRC policy**, including the potential to pre-empt State authority to establish more stringent standards, a concern that a great deal of BRC material could be disposed of in ordinary landfills, the lack of clear assurances that the NRC would be able to track and enforce compliance, and the fact that the maximum allowable exposure from releasable materials (10 mrem) was two and one-half times the U.S. Environmental Protection Agency (EPA) drinking water standard (4 mrem).<sup>6</sup> Two years later, the Energy Policy Act of 1992 revoked the NRC's BRC policy statements entirely.<sup>7</sup>

After placing the initial moratorium on the BRC policy statements, the NRC proposed a “BRC **consensus process**” in 1991 to convene representatives from major groups interested in the development and implications of a BRC policy. That process, however, was canceled several months later when a major environmental group declined to participate.

With regard to decommissioning, three of its most important aspects are affected directly by BRC-type criteria, whether pre-established by formal standards or ad hoc:

1. The residual radioactivity levels that determine when a site can be released for unrestricted use (the current goal of decommissioning);
2. The amount of radioactive waste requiring special disposal; and
3. **The extent to which slightly contaminated material maybe reused or recycled in general commerce.**

By March 1992, the NRC decided to abandon a generic BRC approach and develop instead specific standards for different licensee activities—such as residual radioactivity standards for decommissioning—in separate rulemakings. Therefore, the moratorium on the BRC policy statements and the termination of the BRC consensus process led to the separate treatment of residual radioactivity standards in the current enhanced participatory rulemaking.

ADDITIONAL SOURCES: 57 *Federal Register* 58727-58730 (Dec. 11, 1992): 10 CFR Part 20, Radiological Criteria for Decommissioning of NRC-Licensed Facilities; Workshops.

U.S. Nuclear Regulatory Commission, Office of the General Counsel, “Proposed **Rulemaking** To Establish Radiological Criteria For Decommissioning: Issues For Discussion At Workshops,” unpublished paper.

U.S. Nuclear Regulatory Commission, “Briefing on **Rulemaking** Process for Developing Residual Radioactivity Standards for Decommissioning,” Mar. 11, 1992, unpublished briefing transcript.

<sup>6</sup> See various testimony at hearings before the House Subcommittee on Energy and the Environment, Committee on Interior and Insular Affairs, Hearings on the Nuclear Regulatory Commission's Below Regulatory Concern (BRC) Policy, July 26, 1990, Serial No. 101-29.

<sup>7</sup> Public Law 102-466, 106 Stat. 3122, Sec. 2901(b).

Public acceptance of minimal radioactive releases at operating nuclear facilities suggests that low levels of radioactivity are less of a concern if land use is restricted and regulatory oversight is maintained. For example, in the context of commercial nuclear power operations, regulatory criteria specifying acceptable levels of radioac-

tive releases are prescribed and enforced, such as the release of small quantities of tritium to local surface water. Such releases have been made at plant sites for decades,<sup>9</sup> but there has been no major, visible public effort to ban them.

Even with restricted land uses and some maintenance of regulatory oversight, however,

<sup>9</sup> Kenneth Carr, Chairman, U.S. Nuclear Regulatory Commission, testimony at hearings before the House Subcommittee on Energy and the Environment, Committee on Interior and Insular Affairs, July 26, 1990, Serial No. 101-29, p. 85.

the public may have concerns about the consistency of residual radioactivity standards for decommissioning with other Federal and State radiological standards. For example, the current EPA standard for residual radioactivity at inactive uranium processing sites (40 CFR 192.12) is four times higher (at 20 microrems per hour above background levels) than current NRC criteria for decommissioned nuclear power plant sites. In addition, many view the regulatory risk goals for limiting cancer risks after radiological cleanups as inconsistent with those for hazardous chemical cleanups.<sup>10</sup> Such discrepancies—perceived or real—could complicate the development and implementation of future residual radioactivity standards and decommissioning plans.

The NRC is pursuing an “enhanced participatory rulemaking” to develop formal residual radioactivity standards for decommissioning.<sup>11</sup> Issues raised during public meetings include the following:

- whether to allow *restricted* land uses at some sites as an alternative to unrestricted release;
- ensuring consistency between proposed standards and existing federal health and safety regulation;
- determining the appropriate level and distribution of radiological and nonradiological risks from decommissioning, LLW disposal, and waste transportation;
- determining the nature of licensee responsibility for residual radioactivity *after* a license is terminated; and
- ensuring the development of clear testing criteria and the existence of adequate technology to measure and verify compliance with any promulgated standards.

By addressing these concerns, the NRC will improve the likelihood that States, local authorities, licensees, and the public will accept future residual radioactivity standards. In addition, the role and legal authority of both the NRC and the EPA, if any, at retired plant sites may require clarification, particularly in case additional cleanup is required after an NRC license has been terminated. Understanding the regulatory roles of both the NRC and the EPA after site release may be critical to participating States, local authorities, licensees, and the public as residual radioactivity standards are developed. In general, if Federal agencies exercise no role or appear to have little or no authority at plant sites after license termination, many parties may expect more stringent cleanup levels than might otherwise be selected.

Under the current regulatory definition, the only expected outcome of decommissioning is license termination and site release for *unrestricted* use (e.g., 10 CFR 50.2). In some cases, however, cleanup to a level suitable for unrestricted use may be neither necessary for public health and safety nor economically desirable, because the expected radiation exposures at a decommissioned power plant site will vary depending on its subsequent use. For example, agricultural activities at released plant sites would introduce different exposure pathways and doses than residential use of the same area.<sup>12</sup> Rather than introduce the added occupational risk and economic cost of remediating a site to permit any activity whatsoever (such as farming), a better option at some sites maybe remediation to a level allowing restricted use for select activities, such as continued power production, provided that future exposures from those activities will com-

<sup>10</sup> See, for example, S.L. Brown, “Harmonizing Chemical and Radiation Risk Management,” *Environmental Science and Technology*, vol. 26, No. 12, 1992, pp. 2336-2338.

<sup>11</sup> 57 *Federal Register* 58727-58730 (Dec. 11, 1992).

<sup>12</sup> W.E. Kennedy, Jr., D.L. Streng, Battelle Pacific Northwest Laboratory, *Residual Radioactive Contamination From Decommissioning: Technical Basis for Translating Contamination Levels to Annual Total Effective Dose Equivalent*, NUREG/CR-5512, vol. 1 (Washington DC: U.S. Nuclear Regulatory Commission, October 1992).



ply with regulatory goals and standards for the protection of public and occupational health and the environment.

Power plant sites are developed industrial facilities, generally located near water, transport, and electrical infrastructure. As a result, some sites may be better-suited for further power production or other industrial activities, rather than other uses such as farming or public recreation. Therefore, remediating a site to allow future uses that are unlikely to occur may be unwarranted from a health protection or economic perspective. At the same time, States, local authorities, and the public may accept or prefer restricted land uses or access at some former nuclear facility sites based on concerns about health and safety from any residual radioactivity on site.

To increase the options to perform site cleanups that protect public health and the environment and that are economically feasible, alternatives to unrestricted use may be worth considering, such as restricted use for other industrial purposes. Thus, more than one decommissioning goal (unrestricted use) and more than one residual radioactivity standard may be appropriate. Given the extended periods allowed for some decommissioning methods (SAFSTOR, ENTOMB), restricted use is already practiced at many sites with retired nuclear plants. That is, current regulations allow an extended period of restricted use before final site release, and the concept may be worth extending beyond license termination.

Residual radioactivity standards have implications for both radiological and nonradiological risks during and after decommissioning. Similar to most hazardous chemical remediation, nuclear decommissioning does not eliminate, but rather isolates and transfers, contaminants from one site (such as a nuclear power plant, a research laboratory, or a medical clinic) to another (the treatment, storage, or disposal sites). Decommissioning

crews operate a variety of electrical and mechanical equipment to decontaminate and demolish retired facilities, while waste transport to disposal sites adds risks to haulers and other people living beyond the plant site.

Each unit of radiological contamination removed from a site, therefore, confers both radiological and nonradiological risks on and offsite. As a result, the nature and stringency of residual radioactivity standards will determine how much material will require isolation and transport and will affect the balance of total radiological and nonradiological risks associated with decommissioning. As these comments suggest, decisions about “how clean is clean enough?” are fundamentally decisions about the acceptable levels and distribution of the risks associated with decommissioning.

Other important aspects of residual radioactivity standards are measurability and verification, which become increasingly difficult as standards become more stringent, particularly in the range of a few millirems or less.<sup>13</sup> Background radiation levels on any land area may vary several millirems or more, depending on the exact location sampled, its geology, and the weather. Therefore, measuring and verifying compliance with residual radioactivity standards may be difficult and may affect decommissioning practicability and project costs if their stringency approaches background levels. Such stringent cleanup levels may also compel some licensees to remediate site radioactivity associated with previous, allowed releases.

Finally, residual radioactivity standards may have substantial impacts on final decommissioning costs, because they will determine the amount of material requiring removal and disposal. The current NRC financial assurance rules (discussed below), as well as most cost estimates performed by private contractors, assume final residual radioactivity levels given in the current NRC

---

<sup>13</sup> William Dornsife, Director, Bureau of Radiation Protection, Pennsylvania Department of Environmental Resources, personal communication, May 6, 1993.

guidance, but those levels may change in the future. At present, estimates of decommissioning costs typically assume residual radioactivity standards no more stringent than about 10 millirems per year,<sup>14</sup> the level specified in the now revoked BRC policy, but the NRC, States, local authorities, or the public may expect more stringent standards in the future.

## RADIOACTIVE WASTE DISPOSAL

The essential challenge of decommissioning is to remove and dispose of radioactive waste, while keeping occupational and other exposures as low as possible. There are three major classes of commercial nuclear plant waste, based on the composition and radioactivity of the materials involved: LLW, mixed LLW, and high-level waste (HLW).<sup>15</sup> All three kinds of waste are generated from both operating and decommissioning nuclear power reactors. LLW represents more than 99 percent of the volume of all commercial nuclear waste but less than 0.1 percent of the total radioactivity. Spent nuclear fuel, on the other hand, the only HLW form in the commercial nuclear power industry, represents

less than 1 percent of the volume, but more than 99.9 percent of the radioactivity, of commercial nuclear waste.<sup>16</sup> The other major class, mixed waste, is a special subset of LLW composed of both radioactive and hazardous chemical elements, which poses a special problem for Federal regulators (discussed below).

Waste disposal is a major portion of expected decommissioning costs. The estimated cost of shipping and disposing LLW is over one-third of the total estimated cost of DECON (immediate dismantlement) decommissioning for very large (more than 1,100-megawatt (MW)) electric light water reactors.<sup>17</sup> This section reviews the classification of major decommissioning wastes, projections of the amounts generated, and disposal options.

### ■ Low-Level Waste

The **Low-Level** Radioactive Waste Policy Act (Public Law 96-573; LLRWPA) and the Low-Level Radioactive Waste Policy Amendments Act of 1985 (Public Law 99-240; LLRWPA) defined LLW by what it is not: radioactive waste not classified as HLW, spent nuclear fuel, or

<sup>14</sup> See, for example, U.S. Nuclear Regulatory Commission, Office of Nuclear Regulatory Research, *Final Generic Environmental Impact Statement on Decommissioning of Nuclear Facilities*, NUREG-0586 (Washington, DC: August 1988), pp. 2-12 to 2-13.

<sup>15</sup> Two other classes of radioactive waste—uranium mill tailings and transuranic waste—exist but are not associated with commercial nuclear power plant decommissioning and consequently are not discussed in this report. (Uranium mill tailings are generated by uranium ore processing and contain very low radioactivity. Transuranic (TRU) waste also contains very low radioactivity (akin to LLW) and is composed of long-lived radioactive elements heavier than uranium (hence the name); TRU waste is mostly plutonium and derives almost exclusively from nuclear weapons production.) M. Holt and J.E. Mielke, *Civilian Radioactive Waste Management: Technical and Policy Issues*, 91-867 ENR (Washington DC: Congressional Research Service, Dec. 10, 1991), pp. 4,27.

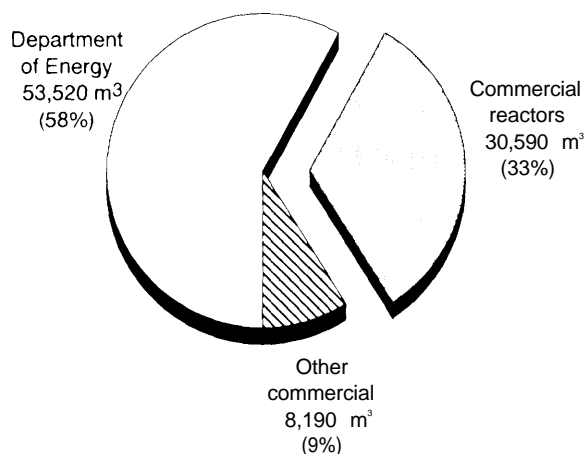
<sup>16</sup> At the end of 1991, the sum of commercial LLW disposed of historically in the United States amounted to 1.4 million cubic meters with a total activity of about 5.7 million curies. By comparison, commercial spent fuel volumes totaled about 9,500 cubic meters, with a total activity of 23.2 billion curies. U.S. Department of Energy, *Integrated Data Base for 1992: U.S. Spent Fuel and Radioactive Waste Inventories, Projections, and Characteristics*, DOE/RW-0006, Rev. 8 (Washington, DC: October 1992), pp. 9, 14. A curie (Ci) is a common measure of radioactive decay, representing 37 billion disintegrations per second.

<sup>17</sup> The estimate varies depending on whether the reactor is a BWR (34 percent) or a PWR (38 percent). G.J. Konzek and R.I. Smith, Battelle Pacific Northwest Laboratory, *Technology, Safety and Costs of Decommissioning a Reference Boiling Water Reactor Power Station: Technical Support for Decommissioning Matters Related to Preparation of the Final Decommissioning Rule*, NUREG/CR-0672, Addendum 3 (Washington, DC: U.S. Nuclear Regulatory Commission, July 1988), p. 3.1; and G.J. Konzek and R.I. Smith, Battelle Pacific Northwest Laboratory, *Technology, Safety and Costs of Decommissioning a Reference Pressurized Water Reactor Power Station: Technical Support for Decommissioning Matters Related to Preparation of the Final Decommissioning Rule*, NUREG/CR-0130, Addendum 4 (Washington, DC: U.S. Nuclear Regulatory Commission, July 1988), p. 3.1. As shorthand, the NRC study reactors are referred to as the “reference reactors” in this report. The cost estimates shown here represent the shipment and disposal of all LLW and the shipment only of spent fuel. Delays in developing a national geologic repository for commercial spent fuel, however, may require many licensees to construct interim storage capacity on their sites, an unanticipated and costly enterprise discussed in more detail in ch. 3.

uranium or thorium mill tailings and mill wastes is LLW.<sup>18</sup> Roughly 92,000 cubic meters (m<sup>3</sup>) (or 3,249,000 cubic feet (ft<sup>3</sup>)) of LLW are disposed annually in the United States. Most (about 58 percent) stems from U.S. Department of Energy (DOE) activities, including defense programs, uranium enrichment, naval propulsion, and research and development (R&D) projects (figure 4-1). Commercial nuclear power production—including uranium conversion, fuel fabrication, and power plant operations—accounts for another 33 percent. Other commercial enterprises, such as radiochemical manufacturers, laboratories, hospitals, universities, and medical schools, account for the remaining 9 percent.<sup>19</sup>

LLW is produced during nuclear power plant operations, repair and maintenance outages, and decommissioning (box 4-B). In 1990, operating pressurized water reactors (PWRs) in the United States disposed an average 108 m<sup>3</sup> of solid LLW, less than one-fifth of the 1980 average (figure 4-2). The same year, operating boiling water reactors (BWRs) disposed an average 301 m<sup>3</sup> of solid LLW, less than one-third of the 1980 average (figure 4-3).<sup>20</sup> Typical solid LLW includes contaminated worker clothing, gloves, equipment, and tools. Operating plants also generate some wet LLW, which consists of spent ion exchange resins (used to regenerate chemical decontaminants), plant sludges, and evaporator concentrates.<sup>21</sup>

**Figure 4-1-Sources of Low-Level Waste in the United States, 1991**



SOURCE: U.S. Department of Energy, *Integrated Data Base for 1992: U.S. Spent Fuel and Radioactive Waste Inventories, Projections, and Characteristics*, DOE/RW-0006, Rev. 8 (Washington, DC: October 1992), pp. 117, 121.

Rising disposal costs in the 1980s spurred LLW volume reductions, largely from waste compaction and improved management (waste segregation, storage, evaporation, and incineration).<sup>22</sup> Between 1980 and 1991, annual commercial LLW disposal volumes decreased from about 100,000 m<sup>3</sup> (3.5 million ft<sup>3</sup>) to 34,000 m<sup>3</sup> (1.2 million ft<sup>3</sup>),<sup>23</sup> even with the addition of many new nuclear power plants, the major source of commercial LLW.

The NRC distinguishes four LLW types, ranked by increasing radioactivity: Class A, Class

<sup>18</sup> 42 U.S.C. 202 l(b).

<sup>19</sup> U.S. Department of Energy, *Integrated Data Base for 1992: U.S. Spent Fuel and Radioactive Waste Inventories, projection, and Characteristics*, DOE/RW-0006, Rev. 8 (Washington, DC: October 1992), pp.117, 121. Cubic meters are converted to cubic feet by dividing the former by 0.0283168.

<sup>20</sup> Institute of Nuclear Power Operations, "1990 Performance Indicators for the U.S. Nuclear Utility Industry" (Atlanta, GA: March 1991). Note: More recent figures for LLW produced by commercial power plants are available from INPO but are no longer given as averages, preventing simple comparisons with earlier data. As a result, the more recent figures are not given here.

<sup>21</sup> S.W. Long, *The Incineration of Low-Level Radioactive Waste: A Report for the Advisory Committee on Nuclear Waste*, NUREG-1393 (Washington, DC: U.S. Nuclear Regulatory Commission, June 1990), p. 2.

<sup>22</sup> See, for example, U.S. Department of Energy, Office of Environmental Restoration and Waste Management, *1991 Annual Report on Low-Level Radioactive Waste Management Progress*, DOE/EM-0091P (Washington, DC: November 1992), pp. B-3 to B-4.

<sup>23</sup> W.R. Hendec, "Disposal of Low-Level Radioactive Waste: Problems and Implications for Physicians," *Special Communication* *Journal of the American Medical Association*, vol. 269, No. 18, May 12, 1993, p. 2404.

### Box 4-B—Low-Level Radioactive Waste and Decommissioning

Three general groups of low-level waste (LLW) stem from decommissioning power reactors. Neutron-activated materials generally contain significant quantities of long-lived radionuclides, particularly nickel-59 (75,000-year half-life), nickel-63 (100-year half-life), and niobium-94 (20,300-year half-life). Materials are activated when neutrons dispersed from the fission reaction collide with trace metals in their structures. A reactor pressure vessel (RPV), its internal components, and the surrounding concrete biological shield are the major plant components that undergo activation.<sup>1</sup>

Even after 40 years of operation, a RPV and its concrete biological shield will generally rank as Class A LLW, though some reactor internals--incore instrumentation, upper and lower guide structures, pressurized water reactor (PWR) control rod assemblies, **boiling water reactor (BWR) control rod blades** may undergo enough activation to rank as high as greater-than-Class-C (GTCC) waste.<sup>2</sup> In cases where plant operations were short (such as Shoreham) or availability was low (such as Fort St. Vrain), neutron-activation will be less significant, and the existing waste will generally be classified low (e.g., Class A). Alternatively, where operations were far longer (15 to 20 years), total plant radioactivity actually levels off, because of the short half-life (5 years) of cobalt-60, the major contaminant in operating plants.

Contaminated **materials are standard** materials such as steel and concrete that contain or have embedded trace amounts of short-lived radionuclides, all of which are neutron-activated materials. In general, contamination is caused by the settling or adherence of activated products on internal surfaces such as piping. While contaminated materials can be cleaned (i.e., decontaminated), activated materials must be removed by structural disassembly. The most common radionuclides in contaminated materials are cobalt-60 (5-year half-life) and cesium-137 (30-year half-life), although some long-lived radionuclides may be involved as well. Most of the piping and equipment and much of the concrete in the buildings containing and surrounding the reactor vessel become contaminated from power operations. These structures include the containment, fuel, auxiliary, control and, in the case of BWRs, turbine generator buildings. The average concentrations of the short-lived radionuclides contaminating these structures is generally low enough to rank their materials as Class-A LLW.<sup>3</sup>

The last general group of decommissioning waste, other radioactive waste, is composed of materials that become contaminated when they are used by plant workers, such as **gloves, rags, tools**, plastic sheeting, and chemical decontaminants. Like conventional contaminated waste, other radioactive waste is largely composed of the same short-lived radionuclides (cobalt-60 and cesium-137), with perhaps some small portions of long-lived radioisotopes. The distinction made between contaminated and other radioactive waste is worth noting, however, because the latter is not part of the original physical plant (concrete, piping, reactor vessel, turbines) and needs to be managed differently because of its mobility. Such radioactive waste is generally Class A, although as much as 25 percent by volume may qualify as Class B.<sup>4</sup>

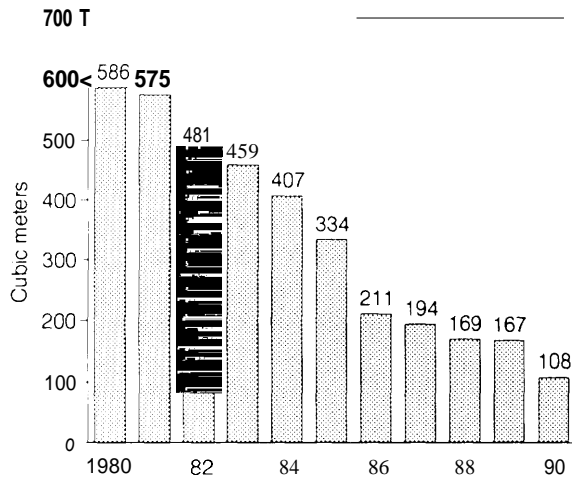
<sup>1</sup>E.S. Murphy, *Technology, Safety and Costs of Decommissioning a Reference Pressurized Water Reactor Power Station: Classification of Decommissioning Wastes*, NUREG/CR-0130, Addendum 3 (Washington, DC: U.S. Nuclear Regulatory Commission, September 1984), p. 2.1. Half-life information is from U.S. Department of Energy, *Integrated Data Base for 1992: U.S. Spent Fuel and Radioactive Waste Inventories, Projections, and Characteristics*, DOE/RW-0006, Rev. 8 (Washington, DC: October 1992), app. B, pp. 255-261.

<sup>2</sup>Thomas s. LaGuardia, President, TLG Engineering, letter to the Office of Technology Assessment, Jan. 22, 1993.

<sup>3</sup> *Ibid.*; and E.S. Murphy, Battelle Pacific Northwest Laboratory, *Technology, Safety and Costs of Decommissioning a Reference Boiling Water Reactor Power Station: Classification of Decommissioning Wastes*, NUREG/CR-0672, Addendum 2 (Washington, DC: U.S. Nuclear Regulatory Commission, September 1984), p. 2.1. Note: The turbine generator building in BWRs becomes contaminated by the direct flow of reactor coolant water to the turbines, a unique aspect of BWR design that allows greater generation efficiency relative to PWRs. Such flow does not occur in PWRs, where steam generators heat water in a secondary loop that drives the turbines. However, steam generator leaks, often from ruptured or cracked tubes, can lead to PWR turbine contamination.

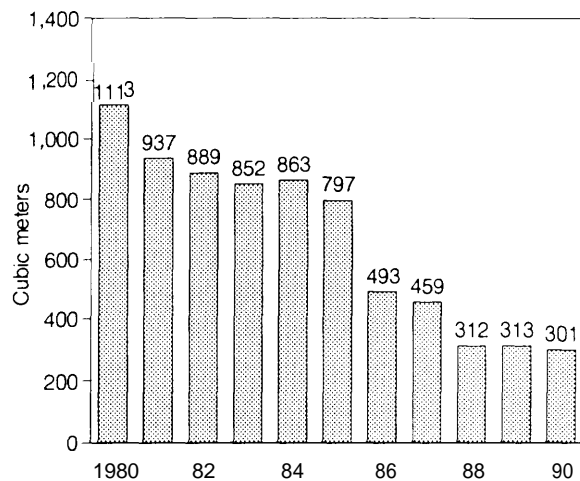
<sup>4</sup>*Ibid.*, p. 2.2.

**Figure 4-2—Solid Low-Level Waste Volumes From Operating Pressurized Water Reactors in the United States, Annual Averages, 1980-1990**



SOURCE: Institute of Nuclear Power Operations, "1990 Performance Indicators for the U.S. Nuclear Utility Industry" (Atlanta, GA: March 1991).

**Figure 4-3—Solid Low-Level Waste Volumes From Operating Boiling Water Reactors in the United States, Annual Averages, 1980-1990**



SOURCE: Institute of Nuclear Power Operations, "1990 Performance Indicators for the U.S. Nuclear Utility Industry" (Atlanta, GA: March 1991).

B, Class C, and greater-than-Class C (GTCC).<sup>24</sup> Classification depends on the type and concentration of the radionuclides present, which are determined by site-specific conditions, such as the duration of power operations and the amount of activated trace metals (such as nickel and copper) contained in the reactor and steam supply system. Class A waste contains the least radioactivity and represents the lowest risk to public health and the environment. Most of the piping, concrete, and equipment located in a nuclear power plant will qualify as Class A waste, including significant portions of a reactor pressure vessel. Other common Class A wastes

include contaminated tools, worker clothing, and protective plastic sheeting.<sup>25</sup>

Class A waste represents about 97 percent of total commercial LLW volumes, emits very little heat and radiation, requires no special shielding to protect workers or the public, and remains harmful for about one century. Classes B and C waste remain harmful for 300 to 500 years, while GTCC waste is harmful for several hundred to several thousand years.<sup>26</sup>

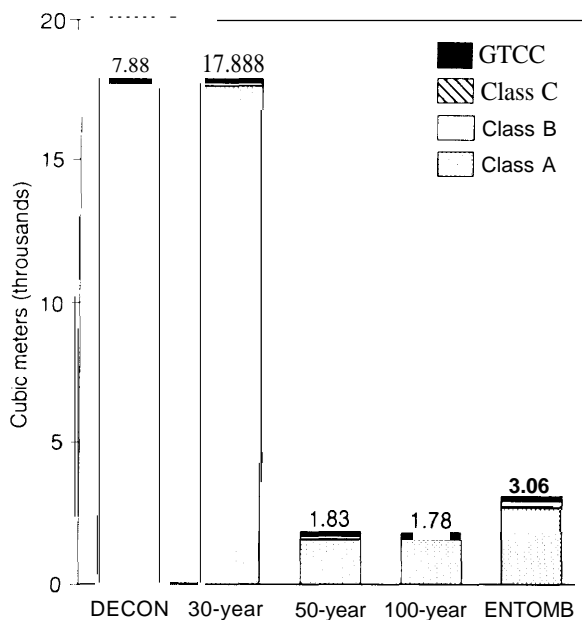
While Class A waste comprises almost the entire volume of commercial LLW disposed annually, its total radioactivity is relatively small. This highlights a general, though not absolute,

<sup>24</sup> 10 CFR 61.55.

<sup>25</sup> E.S. Murphy, Battelle Pacific Northwest Laboratory, *Technology, Safety and Costs of Decommissioning a Reference Pressurized Water Reactor Power Station: Classification of Decommissioning Wastes*, NUREG/CR-0130, Addendum 3 (Washington DC: U.S. Nuclear Regulatory Commission, September 1984), pp. 2.1-2.2, 6.3-6.9; and E.S. Murphy, Battelle Pacific Northwest Laboratory, *Technology, Safety and Costs of Decommissioning a Reference Boiling Water Reactor Power Station: Classification of Decommissioning Wastes*, NUREG/CR-0672, Addendum 2 (Washington DC: U.S. Nuclear Regulatory Commission September 1984), pp. 2.1-2.2, 6.3-6.9.

<sup>26</sup> U.S. Congress, Office of Technology Assessment *Partnerships Under Pressure: Managing Commercial Low-Level Radioactive Waste*, OTA-O-426 (Washington, DC: U.S. Government Printing Office, November 1989), p. 81; and U.S. Congress, Office of Technology Assessment, *An Evaluation of Options for Managing Greater-Than-Class-C Low-Level Radioactive Waste*, OTA-BP-O-50 (Washington DC: October 1988), p. 38.

**Figure 4-4-Projected Low-Level Waste Volumes From Decommissioning a Reference Pressurized Water Reactor as a Function of Storage Period**



SOURCE: E.S. Murphy, Pacific Northwest Laboratory, *Technology, Safety and Costs of Decommissioning a Reference Pressurized Water Reactor Power Station: Classification of Decommissioning Wastes*, NUREG/CR-0130, Addendum 3 (Washington, DC: U.S. Nuclear Regulatory Commission, September 1984), p. 2.3, 4.3.

characteristic of LLW: the greater health and environmental risks are posed by waste classes possessing the lower total volumes, most notably GTCC waste. This is particularly important to appreciate about decommissioning waste, where the great volumes of several LLW classes account for far less radioactivity than the less voluminous but more active GTCC waste and spent nuclear fuel.

#### LLW DECOMMISSIONING VOLUMES AND DISPOSAL OPTIONS

According to NRC projections, decommissioning 1,100-MW light water reactors that have operated their full 40-year licensed lives will generate roughly 18,000 m<sup>3</sup> (636,000 ft<sup>3</sup>) of LLW, about 98 percent of which is Class A

(figures 4-4 and 4-5). The NRC is currently revising these estimates. ENTOMB produces more LLW than 50- and 100-year SAFSTOR, because the NRC estimate assumes dismantlement of the reactor internals prior to final entombment in order to remove long-lived radionuclides in the vessel that would prevent site release within a reasonable period (e.g., 100 years). An extended storage period prior to any internals dismantlement and final entombment, however, could possibly reduce total ENTOMB LLW volumes, depending on the types, concentration, and distribution of radionuclides remaining after plant shutdown.

Based on current information, decommissioning a large commercial power plant may generate more LLW than generated during its operations. As suggested above, operating commercial nuclear power plants in the United States have steadily decreased their LLW disposal volumes for more than a decade. From 1980 to 1990, U.S. operating PWRs generated average annual LLW volumes of 336 m<sup>3</sup> and operating BWRs 666 m<sup>3</sup>, but the actual amounts disposed in recent years have been far lower.<sup>27</sup> If LLW disposal volumes from operating plants in recent years represent the likely annual average over 40 years of operation, DECON decommissioning will generate at least 50 percent more LLW than generated during plant operations. Of course, LLW volume reduction efforts during decommissioning may substantially lower the expected amounts of disposed waste, but the development of residual radioactivity standards more stringent than current regulatory criteria would have the opposite effect.

As figures 4-4 and 4-5 suggest, waiting as much as 50 years to dismantle a reactor is expected to reduce final LLW volumes substantially—90 percent for both PWRs and BWRs. Shorter waiting periods have less of an effect; LLW disposal volumes are virtually unchanged when a 30-year storage period is assumed. For both PWRs and BWRs, 30 years of storage would

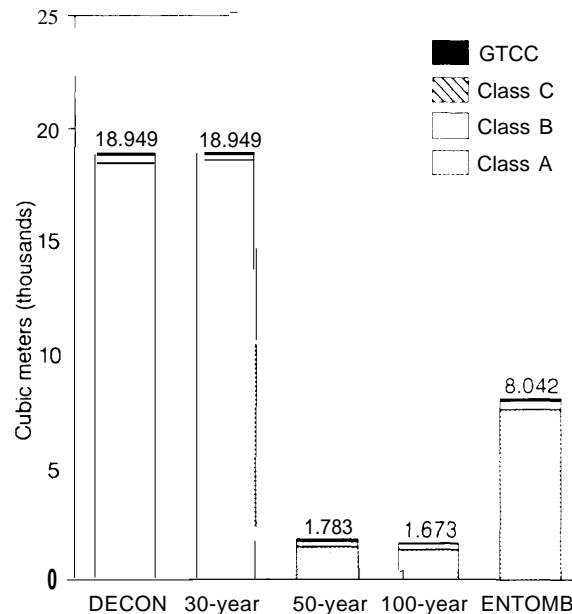
<sup>27</sup>Institute of Nuclear Power Operations, "1990 Performance Indicators for the U.S. Nuclear Utility Industry" (Atlanta, GA: March 1991).

allow a large portion of Class B waste to decay to Class A status, but the volumes of other waste classes (C and GTCC) would remain the same.

Under NRC rules, the first three LLW classes may be disposed by shallow land burial, although packaging, transport, and disposal requirements are progressively more stringent with each waste class (A to C). Other disposal technologies (reinforced vaults, modular concrete canisters, concrete bunkers) are available but are more expensive and have not yet been implemented.<sup>28</sup> Through arrangements with the NRC, 29 States (known as “Agreement States”) regulate these first three LLW classes. The last class, GTCC, is not suitable for shallow land burial and must be disposed of by the Federal Government in a geologic repository (10 CFR 61), which is not yet available.

The first LLW disposal site opened in Nevada in 1962 (Beatty), and five more were operating by 1971. Three of these sites closed later in the 1970s,<sup>29</sup> and Beatty closed January 1993. As a result, only two sites are in operation today: Barnwell (South Carolina) and Richland (Washington). To encourage the development of more LLW disposal facilities, Congress passed the Low-Level Radioactive Waste Policy Act in 1980 (P.L. 95-573; LLRWPA). This statute directed States to assume responsibility for LLW disposal and encouraged the formation of regional interstate compacts to manage LLW. Compacts were authorized to restrict LLW disposal access to their member States beginning in 1986. At present, the Richland site is restricted to members of the Northwest and Rocky Mountain compacts, and out-of-compact access to the Barnwell site will continue until July 1, 1994. After that, Barnwell access will be restricted to members of the

**Figure 4-5-Projected Low-Level Waste Volumes From Decommissioning a Reference Boiling Water Reactor as a Function of Storage Period**



SOURCE: E.S. Murphy, Pacific Northwest Laboratory, Technology, Safety and Costs of Decommissioning a Reference Boiling Water Reactor Power Station: Classification of Decommissioning Wastes, NUREG/CR-0672, Addendum 2 (Washington, DC: U.S. Nuclear Regulatory Commission, September 1964), p. 2.3, 4.3.

Southeast compact for 18 more months, at which time the facility is scheduled to close.<sup>30</sup>

In 1985, with no new LLW disposal facilities under development, Congress passed the Low-Level Radioactive Waste Policy Amendments Act (P.L. 99-240; LLRWPA). This legislation postponed the allowable access restrictions to 1993 and authorized surcharges on LLW disposed by licensees belonging to any compact that was failing to make progress towards opening

<sup>28</sup> W.R. Hendee, “Disposal of Low-Level Radioactive Waste: Problems and Implications for Physicians,” Special Communication, *Journal of the American Medical Association*, vol. 269, No. 18, May 12, 1993, p. 2405.

<sup>29</sup> These three sites were in West Valley, New York (closed 1975); Maxey Flats, Kentucky (closed 1977); and Sheffield, Illinois (closed 1978), U.S. Department of Energy, *Integrated Data Base for 1992: U.S. Spent Fuel and Radioactive Waste Inventories, Projections, and Characteristics*, DOE/RW-0006, Rev. 8 (Washington, DC: October 1992), pp. 132, 136.

<sup>30</sup> “Barnwell Wrote Site to Remain Open,” *Nuclear Engineering International*, vol. 37, No. 458, September 1992, p. 4.



GRETCHEN McCABE

*Barnwell, SC, and Richland, WA, are the two LLW disposal facilities remaining in operation in the United States. Barnwell (above) is scheduled to close in 1996, and Richland (right) no longer accepts waste generated outside the Rocky Mountain and Pacific Northwest regions.*



ETC. EN McCAB

new disposal sites.<sup>31</sup> In many cases, these surcharges have become greater than the nominal disposal fee. For example, in 1990, the fees at the three existing LLW disposal sites ranged from \$32 to \$41 per ft<sup>3</sup> for the least active waste. Additional fees could be imposed, depending on the waste phase (solid or liquid), weight, and the surface radioactivity of the containing vessel.<sup>32</sup> The authorized surcharge for noncompact licensees that same year, however, was \$40 per ft<sup>3</sup>, which tripled to \$120 per ft<sup>3</sup> in 1992 for LLW

generators located within any State or compact region that had failed to apply for a new LLW facility by that time.<sup>33</sup>

The future amounts of both the LLW fees and surcharges (as well as nonmember access to other compact disposal sites) are two important uncertainties with projecting future LLW decommissioning disposal options and costs. Between 1978 and 1986, nominal LLW disposal fees increased ten fold, from \$3 to \$30 per ft<sup>3</sup> (excluding surcharges and other fees).<sup>34</sup> Rates at new dis-

<sup>31</sup> A provision of this statute that required States without LLW disposal options in 1996 to take title to waste generated within their borders has been ruled unconstitutional. *New York v. United States*, No. 91-543, June 19, 1992,

<sup>32</sup> U.S. Nuclear Regulatory Commission, *Report on Waste Burial Charges: Escalation of Decommissioning Waste Disposal Costs at Low-Level Waste Burial Facilities*, NUREG-1307, Rev. 2 (Washington, DC: July 1991), pp. A-1 to A-8.

<sup>33</sup> Low-Level Radioactive Waste Policy Amendments Act (LLRWPA), Public Law 99-240, 99 Stat. 1849, Sec. 5(d)(1)(C) and 99 Stat. 1854, Sec. 5(e)(2)(D).

<sup>34</sup> R.I. Smith, Battelle Pacific Northwest Laboratory, "Potential Impacts of Extended Operating License Periods on Reactor Decommissioning Costs," PNL-7574 (Richland, WA: Battelle Pacific Northwest Laboratory, March 1991), p. 7.



posal sites are projected at \$200 to \$300 per ft<sup>3</sup>,<sup>35</sup> largely because the new facilities will have lower disposal capacities but similar fixed capital costs. Currently, the minimum LLW disposal charge at Barnwell for generators outside the Southeast compact is \$270 per ft<sup>3</sup>.<sup>36</sup> Where LLW disposal costs will stabilize remains a matter of speculation.

No new LLW disposal sites have been opened since Barnwell began operating in 1971, more than 20 years ago. Since then, no attempt to license a LLW facility has yet succeeded, due to legal, technical, or political reasons, including efforts in California, Connecticut, Illinois, Michigan, Nebraska, New York, and Texas.<sup>37</sup> In part, the experience at closed LLW disposal sites may affect current public attitudes about new site planning; the largest closed facility, Maxey Flats in Kentucky, leaked enough contaminants within a decade of its closure to qualify as an EPA Superfund site in 1986.<sup>38</sup> LLW disposal management and technologies have improved over the last 20 years, but the level of public confidence in the reliability and safety of candidate sites will continue to affect the prospects of developing them.

As an interim measure, several dozen nuclear power licensees have constructed LLW storage facilities at their plant sites, and more plan to do the same.<sup>39</sup> Beginning in 1996, however, NRC

rules discourage the use of onsite LLW storage.<sup>40</sup> In the short term, onsite storage offers cost savings for LLW management by allowing greater radioactive decay of waste before final disposal. In the long-term, though, extended onsite LLW storage may lead to added radioactivity exposures in several ways, including added worker handling, releases from storage containers, additional monitoring requirements during storage, and potential changes to container requirements between storage and final disposal, which could necessitate additional waste handling.<sup>41</sup> In addition, NRC rules governing LLW disposal facility licensing (10 CFR 61.50) may prevent many nuclear power sites from becoming permanent disposal facilities, because power sites are generally located near major bodies of surface water (rivers, bays, coasts), are likely to have high water tables, and could disperse leaked contaminants more readily than other areas more suitable for permanent disposal,

GTCC waste is not suitable for near-surface disposal and requires geologic burial (10 CFR 61.55). As discussed in box 4-B, some reactor vessel internals are expected to undergo sufficient activation over several decades of operation to classify as GTCC waste. As with spent nuclear fuel, the DOE is responsible for accepting and disposing GTCC waste for the commercial power industry, but there is no clear progress in develop-

---

<sup>35</sup> Stephen N. Solomon, Technical Analyst, Office of State Programs, U.S. Nuclear Regulatory Commission, internal NRC memorandum to Carleton Kammerer, Director, Office of State Programs, Nov. 10, 1992.

<sup>36</sup> R.R. Zuercher, "Southeast Compact Commission Bars Central States' Access to Bamwell," *Nucleonics Week*, vol. 34, No. 16, Apr. 22, 1993, p. 11.

<sup>37</sup> J. Clarke, "Deadlines Loom But No LLW Sites Open Yet," *The Energy Daily*, vol. 20, No. 204, Oct. 22, 1992, pp. 1-2; U.S. Congress, General Accounting Office *New York's Adherence to Site Selection Procedures is Unclear*, GAO/RCED-92-172 (Gaithersburg, MD: August 1992); R.R. Zuercher, "Nebraska Officials Going Back to Beginning to Slow LLW Site Progress," *Nucleonics Week*, vol. 33, No. 21, May 21, 1992, pp. 8-9; R.R. Zuercher, "Proposed California Waste Site Mired in Election-Year Politics," *Nucleonics Week*, vol. 33, No. 20, May 14, 1992, p. 11; and U.S. Congress, General Accounting Office, *Slow Progress Developing Low-Level Radioactive Waste Disposal Facilities*, GAO/RCED-92-61 (Gaithersburg, MD: January 1992), pp. 4, 18.

<sup>38</sup> N. Powell, "A Concerned Community: Plutonium Had Migrated Hundreds of Feet," *EPA Journal*, vol. 17, No. 3, July/August 1991, pp. 31-32.

<sup>39</sup> L. Oyen and R. Nelson, Sargent & Lundy Engineers, *Interim On-Site Storage of Low-Level Waste*, vol. 2, Part 2: Survey of Existing On-Site LLW Storage Facilities, EPRI TR-100298 (Palo Alto, CA: Electric Power Research Institute, September 1992), p. 2-1.

<sup>40</sup> 58 *Federal Register* 6735-6736 (Feb. 2, 1993).

<sup>41</sup> 58 *Federal Register* 6731 (Feb. 2, 1993).

ing GTCC packaging, transport, and disposal options.<sup>42</sup> As with spent fuel, therefore, operable GTCC storage or disposal facilities are needed to complete decommissioning work.

## ■ Mixed Waste

Also known as “mixed low-level waste,” this waste is a combination of radioactive and hazardous chemical substances.<sup>43</sup> Joint guidance established by the NRC and the EPA in 1989 defines mixed waste as any waste containing both LLW (as defined by the LLRWPA) and hazardous waste, as listed or characterized in 40 CFR Part 261.<sup>44</sup> The major groups of mixed waste generated in commercial nuclear plants (and the activities they are associated with) include organic compounds (laboratory counting tests and solvents used to clean clothes, tools, equipment, and instruments), waste oil (pumps and other equipment used in radioactive areas), metallic lead (contaminated when used for radioactive shielding), cadmium (welds and welding rods), and chromates (corrosion inhibitors, resins) .<sup>45</sup>

### MIXED WASTE DECOMMISSIONING VOLUMES AND DISPOSAL OPTIONS

Mixed waste represents only a few percent of annual LLW generation, and nuclear utilities consider most of their mixed waste treatable. While there are no national estimates of decommissioning mixed waste volumes, their expected amounts are low relative to conventional LLW. In

1990, operating commercial nuclear power plants in the United States produced an estimated 396 m<sup>3</sup> (14,000 ft<sup>3</sup>) of mixed waste, about 10 percent of the estimated amount from all sources that year. The same year, nuclear utilities were storing an estimated 623 m<sup>3</sup> (22,000 ft<sup>3</sup>) of mixed waste, primarily contaminated chlorofluorocarbons (39 percent), contaminated oil (23 percent), and contaminated lead (20 percent). In the future, material substitutions are expected to decrease final disposal volumes.<sup>46</sup> At present, there are three commercial mixed waste disposal sites (Colorado, Florida, and Utah), but their disposal permits are restricted to select waste groups with low activities.<sup>47</sup>

Part of the challenge with mixed waste management is regulatory: the NRC has authority over the radioactive portion of the material, while the EPA regulates the hazardous chemical portion. Under current EPA rules authorized under the Resource Conservation and Recovery Act (P.L. 94-580; RCRA), land disposal of hazardous waste is restricted, but the only option currently available for LLW disposal is shallow land burial. Compared to problems with both LLW and HLW disposal, mixed waste is a minor waste challenge for operating nuclear plants, but the problem may become more important as more licensees perform decommissioning and pursue license termination in the future. In the future, the DOE may coordinate with States in the development of

<sup>42</sup> Richard G. Ferreira, Assistant General Manager, Sacramento Municipal Utility District, letter to the Office of Technology Assessment, Feb. 18, 1993. See also I. Selin, “The Future for Low-Level Waste Disposal: Where Do We Go From Here?” *Public Utilities Fortnightly*, vol. 131, No. 6, Mar. 15, 1993, p. 55.

<sup>43</sup> High-level waste can mix with hazardous waste as well, but the higher levels of radioactivity associated with that waste alone determine its treatment. U.S. Department of Energy, *Integrated Data Base for 1992: U.S. Spent Fuel and Radioactive Waste Inventories, Projections, and Characteristics*, DOE/RW-0006, Rev. 8 (Washington DC: October 1992), p. 209.

<sup>44</sup> “Results of the National Profile on Commercially Generated Low-Level Radioactive Mixed waste,” unpublished paper presented to the Advisory Committee on Nuclear Waste, U.S. Nuclear Regulatory Commission, Nov. 20, 1992.

<sup>45</sup> U.S. Congress, Office of Technology Assessment, *Partnerships Under Pressure: Managing Commercial Low-Level Radioactive Waste*, OTA-O-426 (Washington DC: U.S. Government Printing Office, November 1989), pp. 85-87.

<sup>46</sup> J. A. Klein, J. E. Mrochek, R. L. Jolley, I. W. Osborne-Lee, A. A. Francis, and T. Wright, Oak Ridge National Laboratory, *National Profile on Commercially Generated Low-Level Radioactive Mixed Waste*, NUREG/CR-5938 (Washington DC: U.S. Nuclear Regulatory Commission, December 1992), pp. xiii, 201, 47, 50-51.

<sup>47</sup> *Ibid.*, pp. 32-35.

additional mixed waste treatment and disposal capacity.<sup>48</sup>

The two facilities currently undergoing active DECON decommissioning (Fort St. Vrain and Shoreham) expect to generate no mixed wastes.<sup>49</sup> These two cases, however, are probably anomalies; most plants retired in the future will contain far more radioactivity from longer operations, increasing the probability that hazardous materials will be contaminated with radiation. Shoreham operated only for the equivalent of two full power days and Fort St. Vrain, although it operated 10 years, achieved only an average 15 percent capacity factor and was of a design (helium gas-cooled) that limits plant contamination. Older, larger light water reactors that operate longer will show far more radioactive contamination, increasing the likelihood of mixed waste generation. In addition, higher levels of radioactivity increase the potential benefits of chemical decontamination, a process that can generate mixed wastes.

## ■ High-Level Waste

**Irradiated** (spent) nuclear reactor fuel is the only HLW generated by commercial nuclear power plants.<sup>50</sup> Spent fuel contains more radioactivity than any other form of commercial radioactive waste. The long-term public health and environmental risks from spent fuel are of far greater concern than LLW, because spent fuel contains greater concentrations of long-lived

radionuclides, some with half-lives on the order of tens of thousands of years and longer.<sup>51</sup>

## SPENT FUEL WEIGHTS AND DISPOSAL OPTIONS

In recent years, total annual spent fuel discharges (measured in metric tons of initial heavy metal) from operating U.S. reactors have amounted to roughly 2,000 tons. The total amount of discharged spent commercial fuel in the United States (1968-1991) is nearly 24,000 tons.<sup>52</sup> Before decommissioning can be completed at any commercial facility, all spent fuel previously discharged to the storage pool and any fuel still present in the reactor vessel must be removed. As discussed in chapter 3, however, the Federal program to dispose spent fuel, as required under the Nuclear Waste Policy Act of 1982 (P.L. 97-425; NWPA), has lagged. In addition to affecting plant life decisions, the current inability to dispose of spent fuel affects decommissioning planning and implementation. Progress in developing interim HLW storage options (e.g., dry cask installations, a Federal monitored retrievable storage (MRS) facility) and a geologic repository are discussed in chapter 3.

The development of a viable, long-term management and disposal strategy for nuclear waste will resolve not only major uncertainties with decommissioning the first generation of commercial nuclear plants but could influence substantially the future prospects of developing a second generation of nuclear reactors in

<sup>48</sup> U.S. Department of Energy, *Department of Energy Strategy for Development of a National Compliance Plan for DOE Mixed Waste*, predecisional draft (Washington DC: November 1992), pp. 4, 20, 24.

<sup>49</sup> For more details on these current decommissioning projects, see boxes 4-C and 4-D.

<sup>50</sup> The regulatory definition of HLW (10 CFR 60.2) also includes the liquid and solid wastes generated by reprocessing spent fuel, but reprocessing no longer occurs in the U.S. commercial power sector and is restricted to cleanup of the nuclear weapons complex. For a review of defense HLW cleanup, see U.S. Congress, Office of Technology Assessment, *Complex Cleanup: The Environmental Legacy of Nuclear Weapons Production, OTA-O-484* (Washington, DC: U.S. Government Printing Office, February 1991); and U.S. Congress, Office of Technology Assessment, *Long-Lived Legacy: Managing High-Level and Transuranic Waste at the DOE Nuclear Weapons Complex, OTA-BP-O-83* (Washington, DC: U.S. Government Printing Office, May 1991).

<sup>51</sup> For example, the half-lives of Nickel-59, Niobium-94, and Iodine-129, all constituents of commercial spent fuel, are 75,000; 20,300; and 15,700,000 years, respectively. U.S. Department of Energy, *Integrated Data Base for 1992: U.S. Spent Fuel and Radioactive Waste Inventories, Projections, and Characteristics, DOE/RW-0006*, Rev. 8 (Washington, DC: October 1992), pp. 280-289.

<sup>52</sup> U.S. Department of Energy, *Energy Information Administration, Spent Nuclear Fuel Discharges From U.S. Reactors 1991, SR/CNEAF/93-01* (Washington, DC: February 1993), p. 21.

the United States. Unless viable disposal options for both LLW and HLW are developed, utility and financial planners and the public will remain reluctant to invest further in nuclear power.

## EXPERIENCE TO DATE

**International** decommissioning experience is limited thus far to small reactors (250 MW and less), which generally had short lives and relatively little contamination. Larger commercial reactors that are being retired today, on the other hand, typically will have operated longer and have far higher levels of contamination. By 2015, the licenses of over 40 operating plants (all but one of them larger, older, and therefore more contaminated than the early plants) may have expired.<sup>53</sup> And based on current economic trends in the nuclear utility industry, one financial industry estimate suggests that from several to as many as 25 nuclear power plants may retire in the next decade and require decommissioning sooner than expected.<sup>54</sup> Commercial nuclear decommissioning, therefore, is likely to become a more visible and controversial political and economic issue in the next few decades.

Although no large commercial reactors have undergone complete decommissioning yet, decades of experience dismantling small experimental and commercial reactors, combined with experience performing major plant upgrades and repairs at large operating units, suggests that decommissioning large commercial nuclear power plants can be accomplished

with existing technologies. The most valuable experience thus far has been dismantling the 72-MW Shippingport PWR, and major plant upgrades, such as removing and replacing steam generators, also suggests that existing technologies are sufficient to decommission large reactors.

Many of the technologies used to decommission nuclear plants are the same ones used to demolish other industrial facilities and buildings, including torches, saws, milling machines, and controlled explosives. Were it not for the considerable residual radiation hazard that remains even after the nuclear fuel is removed, a nuclear power plant could be dismantled and demolished in the same way as any other industrial facility or building. Of course, the benefit of having adequate decommissioning technologies is diminished if waste disposal options are limited or absent.

## ■ U.S. Decommissioning Experience

Experience with decommissioning nuclear power plants in the United States is limited,<sup>55</sup> and work is complete at only four small plant sites, the largest being the 72-MW Shippingport PWR (table 4-1). No large (more than 500 MW) reactors have been decommissioned yet, and the few reactor decommissioning performed thus far offer little indication of the potential costs of large reactor dismantlement, because of their low contamination and small size. By comparison, 96 percent of currently operating commercial reactors in the United States (103 of 107 units) are 500

<sup>53</sup> This assumes all current reactors operate only for the duration of their existing license terms (see table 1-2) and no units receive license renewals.

<sup>54</sup> P.C. Parshley, D.F. Grosser, and D.A. Roulett, Shearson Lehman Brothers, "Should Investors Be Concerned About Rising Nuclear Plant Decommissioning Costs?" *Electric Utilities Commentary*, vol. 3, No. 1, Jan. 6, 1993, p.1.

<sup>55</sup> A total of 286 various nuclear reactors (both civilian and military) have been shut down permanently in the United States. Many have been partially or completely decommissioned, but most were generally very small (less than 10 MWe) noncommercial reactors. Thirty-seven percent (106) of these retired units were military, production, and export reactors, while the greater share (180 units, or 63 percent) were civilian reactors, including 105 test, research, and university reactors (most very small general and university research reactors of less than 1 MWe); 50 experimental reactors (most for space applications); and 25 power reactors, two of which had defense applications. Thus, to date, only 23 central station nuclear electric power units have been closed permanently, and decommissioning is complete at only 4 of them. U.S. Department of Energy, Office of Scientific and Technical Information, *Nuclear Reactors Built, Being Built, or Planned: 1991*, DOE/OSTI-8200-R55 (Washington DC: July 1992), pp. xv, 23-27. (Note: The DOE figures are slightly revised here, in part to reflect the recent retirement of the Yankee Rowe, SONGS-1, and Trojan reactors.) This small subset of 23 retired units is listed in table 4-1.

**Table 4-I—Retired Commercial Nuclear Power Plants in the United States and Their Decommissioning Status**

| Plant                                    | Design rating and type | Operating license issued | Shut down date | Decommissioning approach and status                                 |
|--|------------------------|--------------------------|----------------|---|
| Pathfinder. . . . .                      | 66-MW BWR              | 1964                     | 1967           | DECON completed 1991.   |
| Shippingport. . . . .                    | 72-MW PWR              | 1957                     | 1982           | DECON completed 1989.   |
| Sodium Reactor Experiment. . . . .       | 10-MW SCGM             | 1957                     | 1964           | DECON completed 1983.   |
| Elk River. . . . .                       | 22-MW BWR              | 1962                     | 1968           | DECON completed 1974.   |
| Trojan. . . . .                          | 1,155-MW PWR           | 1975                     | 1993           | Decommissioning plan under development.                             |
| San Onofre Unit 1. . . . .               | 436-MW PWR             | 1967 <sup>a</sup>        | 1992           | Decommissioning planning in progress.                               |
| Yankee Rowe. . . . .                     | 175-MW PWR             | 1961 <sup>a</sup>        | 1992           | Decommissioning plan under development.                             |
| Rancho Seco. . . . .                     | 918-MW PWR             | 1974                     | 1989           | SAFSTOR until 2008; plan under NRC review.                          |
| Shoreham. . . . .                        | 820-MW BWR             | 1989                     | 1989           | DECON in progress since 1992.                                       |
| Fort St. Vrain. . . . .                  | 330-MW HTG             | 1973                     | 1989           | DECON in progress since 1992.                                       |
| La Crosse. . . . .                       | 48-MW BWR              | 1967                     | 1987           | SAFSTOR until 2014.   |
| Three Mile Island Unit . . . . .         | 926-MW PWR             | 1978                     | 1979           | Monitored storage; plant shut down in 1979 due to reactor accident. |
| Dresden Unit 1. . . . .                  | 200-MW BWR             | 1959                     | 1978           | SAFSTOR until 2017.   |
| Humboldt Bay. . . . .                    | 65-MW BWR              | 1962                     | 1976           | SAFSTOR until 2015.   |
| Indian Point Unit 1. . . . .             | 265-MW PWR             | 1962                     | 1974           | SAFSTOR until 2009.   |
| Peach Bottom Unit 1. . . . .             | 40-MW HTG              | 1966                     | 1974           | SAFSTOR.  |
| Fermi Unit 1. . . . .                    | 61-MW SCF              | 1963                     | 1972           | SAFSTOR.  |
| Saxton. . . . .                          | 3-MW PWR               | 1962                     | 1972           | DECON in progress since 1986.                                       |
| Bonus. . . . .                           | 17-MW BWR              | 1964                     | 1968           | ENTOMB.   |
| Carolinas-Virginia Tube Reactor. . . . . | 17-MW PTHW             | 1962                     | 1967           | SAFSTOR.  |
| Piqua. . . . .                           | 11-MW OCM              | 1962                     | 1966           | ENTOMB.   |
| Hallam. . . . .                          | 75-MW SCGM             | 1962                     | 1964           | ENTOMB completed 1968.  |
| Vallecitos. . . . .                      | 5-MW BWR               | 1957                     | 1963           | SAFSTOR.  |

<sup>a</sup> Due to a delay in the issuance of the formal operating licenses, the date of initial commercial operation is given here instead.

KEY: BWR = boiling water reactor; HTG = high-temperature gas-cooled reactor; OCM = organic-cooled and moderated; PTHW = pressure tube, heavy water reactor; PWR = pressurized water reactor; SCF = sodium-cooled, fast reactor; SCGM = sodium-cooled, graphite-moderated reactor.

SOURCES: U.S. Nuclear Regulatory Commission, Office of the Controller, *Nuclear Regulatory Commission Information Digest: 1992 Edition*, NUREG-1350, vol. 4 (Washington, DC: March 1992), pp. 79-93; U.S. Department of Energy, *Integrated Data Base for 1992: U.S. Spent Fuel and Radioactive Waste Inventories, Projections, and Characteristics*, DOE/RW-0006, Rev. 8 (Washington, DC: October 1992), pp. 189-206; and the Office of Technology Assessment 1993.

MW or larger.<sup>56</sup> However, historical decommissioning experience is telling from a technical perspective, suggesting that existing technologies are adequate to decommission today's larger units.<sup>57</sup>

The Elk River reactor was shut down in 1968 after 4 years of operation.<sup>58</sup> Dismantlement was completed in 1974, after 3 years, at a cost then of \$6.15 million; this was the first commercial site

<sup>56</sup> U.S. Nuclear Regulatory Commission, Office of the Controller, *Information Digest, 1992 Edition*, NUREG-1350, vol. 4 (Washington DC: March 1992), app. A, pp. 79-91.

<sup>57</sup> Organisation for Economic Co-Operation and Development, Nuclear Energy Agency, *Decommissioning of Nuclear Facilities: Feasibility, Needs and Costs* (Paris, France: 1986), pp. 8, 31.

<sup>58</sup> D. Borson, *Payment Due: A Reactor-by-Reactor Assessment of the Nuclear Industry's \$25+ Billion Decommissioning Bill* (Washington, DC: Public Citizen Critical Mass Energy Project, Oct. 11, 1990), p. 14.

released for unrestricted use by the Federal Government.<sup>59</sup> The Sodium Reactor Experiment operated only from 1957 to 1964, and dismantlement was initiated in 1976.<sup>60</sup> When decommissioning was completed in 1983, costs totaled about \$16.6 million.<sup>61</sup> Pathfinder operated from 1965 to 1967, when it shut down due to a condenser tube leak; dismantlement began in 1989 and was completed 2 years later.<sup>62</sup> Although they represent technological watersheds, these three small commercial decommissioning projects convey little if any sense of the scale of large reactor decommissioning work, because all were very small, operated for brief periods, and contained far less contamination than larger, older units that will retire in the future.

Shippingport decommissioning, however, has received the most international attention of any completed nuclear power plant dismantlement project. The reactor operated from December 1957 to October 1982, and the reactor buildings and associated nuclear portions of the facility were completely dismantled in less than 4 years (September 1985 to July 1989) at a total cost of \$91.3 million (nominal dollars, by year of expenditure). The turbine generator and remaining secondary systems were not dismantled. From the perspective of project management, the applicability of the Shippingport experience to future large-scale decommissioning projects appears promising—the work was completed with existing technologies on schedule and under budget.<sup>63</sup>

Doubts about the applicability of the Shippingport experience, however, center on project costs. Unlike all of today's large commercial nuclear facilities, which are exclusively owned and operated by utilities and regulated by the NRC, Shippingport was jointly owned by the DOE and the Duquesne Light Company (DLC); the DOE owned the reactor and steam generating portions of the plant, while DLC owned the remaining facilities, such as the generating equipment and the transformer yard. In addition, as a DOE project, Shippingport decommissioning was not regulated by the NRC. The uncommon ownership arrangement between the Federal Government and a private utility was designed both to help demonstrate PWR technology and to generate salable electricity, but it also had the effect of substantially reducing eventual decommissioning costs.

First, as part of its demonstration effort, the DOE replaced the reactor core twice during the plant's life, each time conducting cleanup work, including a full primary cooling system decontamination before the final core was installed.<sup>64</sup> (Replacing reactor cores is not standard practice for commercial nuclear power reactors.) Because a reactor is the most heavily contaminated portion of a nuclear plant, the Shippingport core replacements reduced plant radioactivity substantially. At final shut down, the last Shippingport reactor core had been in operation only 5 years (August 1977 to October 1982), and the radioactivity in the reactor pressure vessel (RPV) was about

<sup>59</sup> U.S. Nuclear Regulatory Commission, Office of Nuclear Regulatory Research, *Final Generic Environmental Impact Statement on Decommissioning of Nuclear Facilities*, NUREG-0586 (Washington, DC: August 1988), p. 1-5.

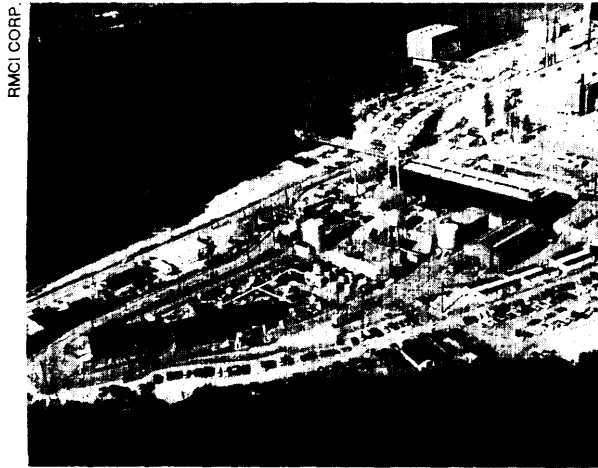
<sup>60</sup> D. Borson, *Payment Due: A Reactor-by-Reactor Assessment of the Nuclear Industry's \$25+ Billion Decommissioning Bill* (Washington, DC: Public Citizen Critical Mass Energy Project, Oct. 11, 1990), p. 15.

<sup>61</sup> J.T.A. Roberts, R. Shaw, and K. Stahlkopf, "Decommissioning of Commercial Nuclear Power Plant@," *Annual Review of Energy* (Palo Alto, CA: Annual Reviews, Inc., 1985), vol. 10, p. 257.

<sup>62</sup> Michael Weber, U.S. Nuclear Regulatory Commission, personal communication, May 6, 1993.

<sup>63</sup> U.S. Congress, General Accounting Office, *Shippingport Decommissioning—How Applicable Are the Lessons Learned?* GAO/RCED-90-208 (Gaithersburg, MD: September 1990).

<sup>64</sup> W. Murphie, "Greenfield Decommissioning at Shippingport: Cost Management and Experience," *Nuclear Decommissioning Economics: Estimates, Regulation, Experience and Uncertainties*, M.J. Pasqualetti and G.S. Rothwell (eds.), *The Energy Journal*, Special Issue, vol. 12, 1991, p. 121.



Decommissioning of the relatively small Shippingport reactor, completed in 1989, was managed by the U.S. Department of Energy. Although done at Shippingport, radiological decommissioning at other sites may *not* require removal of buildings and other structures.

30,000 curies (Ci), which had decayed to 16,000 Ci when decommissioning began 3 years later.<sup>65</sup> For comparison, the projected radioactivity levels in the RPV of an 1,175-MW PWR at shut down (assuming 30 years of effective full power operation) have been estimated at 4.8 million Ci,<sup>66</sup> about 300 times the amount at Shippingport when decommissioning began there.

Second, the small size and low contamination of the Shippingport RPV allowed one-piece disposal. Though relatively large for its low power capacity, the Shippingport RPV was far smaller than typical commercial units, with a height of 25 feet, width of 10 feet, and weight of about 153 tons. Standard-sized vessels in large reactors, however, are 45 to 70 feet high and can

weigh as much as 1,000 tons.<sup>67</sup> Because of their size and expected contamination, the larger vessels at most commercial facilities are likely to require segmentation, which will increase project costs and radiation exposures.

As a third cost saving advantage, Shippingport waste was delivered to Federal facilities, an option not available to typical commercial licensees. Because the DOE managed the project, the highly radioactive spent nuclear fuel was transported to the Idaho National Engineering Laboratory (INEL), and all LLW, including the intact RPV, was buried at the Hanford facility in Washington state. According to the DOE manager of the Shippingport decommissioning project, there has been no effort to determine the cost

<sup>65</sup>U.S. Congress, General Accounting Office, *Shippingport Decommissioning—How Applicable Are the Lessons Learned?* GAO/RCED-90-208 (Gaithersburg, MD: September 1990), p. 16.

<sup>66</sup>R.I. Smith, G.J. Konzek, and W.E. Kennedy, Jr., Battelle Pacific Northwest Laboratory, *Technology, Safety and Costs of Decommissioning a Reference Pressurized Water Reactor Power Station*, NUREG/CR-0130, vol. 2 (Washington, DC: U.S. Nuclear Regulatory Commission June 1978), pp. C-10, C-12. The reference PWR used in this study is the Trojan Nuclear Plant, a recently retired commercial nuclear power plant in Prescott, Oregon. The figure is a projection only, not an actual measured quantity at the plant.

<sup>67</sup>U.S. Congress, General Accounting Office, *Shippingport Decommissioning—How Applicable Are the Lessons Learned?* GAO/RCED-90-208 (Gaithersburg, MD: September 1990), pp. 4-5. These figures reflect RPV weights prior to preparation for disposal. At Shippingport, falling the RPV with concrete and including lifting fixtures increased the package weight to 1,100 tons. Thomas S. LaGuardia, President, TLG Engineering, letter to the Office of Technology Assessment, Jan. 22, 1993.

savings from the unique circumstances at the Shippingport decommissioning.<sup>68</sup>

The reduced LLW costs, however, provide one indication of the reduced costs experienced at Shippingport. If Shippingport was decommissioned today and the LLW disposed at Barnwell, the only facility available to a Pennsylvania licensee, total project costs would be almost \$56 million more, an increase of over 60 percent.<sup>69</sup>

#### CURRENT AND FUTURE DECOMMISSIONING EXPERIENCE

Two recently retired plants—the 819-MW Shoreham BWR and the 330-MW Fort St. Vrain high-temperature gas-cooled reactor (HTGCR)—are currently undergoing DECON decommissioning and, given their size, may provide better indications than Shippingport of the costs, occupational exposures, and waste disposal requirements of standard-sized commercial reactors (boxes 4-C and 4-D). More than a dozen other U.S. civilian nuclear power units are currently planning or undergoing decommissioning as well. An overview of decommissioning plans for recently retired reactors is given in box 4-E.

Additional and potentially important experience with decontamination, decommissioning, waste minimization, and radiation protection will be gained from existing Federal nuclear remediation programs, many associated with weapons facilities. The DOE Environmental Restoration and Waste Management (ERWM) program covering nuclear weapons complex cleanup, the DOE

Formally Utilized Sites Remedial Action Project (FUSRAP) covering former nuclear processing facilities, and the NRC Site Decommissioning Management Plan (SDMP) program for select nuclear material sites will together provide lessons and technological improvements that the industry may find useful as it decommissions commercial power reactors in the future.<sup>70</sup>

The largest of these efforts, the ERWM program, is a multibillion dollar federal effort to remediate and dispose HLW from weapons production, but the nature of this effort is different than commercial nuclear decommissioning in several critical respects. First, unlike commercial nuclear waste, much defense HLW is the liquid byproduct of reprocessing. As a result, a major challenge in defense cleanup has been neutralizing these wastes into more stable forms, such as salt cake, to prepare them for vitrification and final disposal. In the commercial sector, on the other hand, there are no plans to reprocess, neutralize, vitrify, or otherwise transform the solid spent fuel, the only HLW form in the nuclear power industry, because of its existing stability.

Second, a major challenge with defense HLW has been storing and securing the liquid material, where tank leaks threaten local groundwater sources and the risk of fire or explosion in some cases is serious, in part from the accumulation of gases generated by chemical treatment. In addition, the past mixing and treatment of defense HLWs has raised questions about the exact composition of many storage tanks, and sampling

<sup>68</sup> W. Murphie, 'Greenfield Decommissioning at Shippingport: Cost Management and Experience,' *Nuclear Decommissioning Economics: Estimates, Regulation, Experience and Uncertainties*, M.J. Pasqualetti and G.S. Rothwell (eds.), *The Energy Journal*, Special Issue, vol. 12, 1991, p. 121.

<sup>69</sup> This estimate is based on current (1993) Barnwell costs for out-of-region LLW generators of \$270 per cubic foot. Shippingport LLW totaled 214,000 cubic feet (ft<sup>3</sup>) and cost the DOE \$2.2 million (year-of-expenditure dollars) for disposal at Hanford, representing just over \$10 per ft<sup>3</sup>. Westinghouse Hanford Co., *Final Project Report: Shippingport Station Decommissioning Project*, DOE/SSDP-0081 (Richland, WA: U.S. Department of Energy, Richland Operations Office, Dec. 22, 1989), pp. ix, 10. Including only the current out-of-compact disposal surcharge of \$120 per ft<sup>3</sup>, Shippingport decommissioning today just 4 years later would cost about \$26 million more, a total increase to the original nominal cost of about 28 percent. Applying the current Barnwell costs, however, raises the total more than 60 percent.

<sup>70</sup> For example, the DOE Environmental Restoration and Waste Management program recently selected 19 R&D projects to assist with the decontamination and decommissioning of closed nuclear weapons facilities, including projects designed to recycle concrete and scrap metal. "DOE Negotiating Contracts for 19 D&D Projects Valued at \$40 Million," *Weapons Complex Monitor*, vol. 4, Nos. 20 & 21, Mar. 29, 1993, pp. 7-8.



### Box 4-C-The Fort St. Vrain Decommissioning Project

The Fort St. Vrain (FSV) Nuclear Generating Station was a 330-MW high-temperature, gas-cooled reactor owned by the Public Service Co. of Colorado (PSCO). This unique reactor operated commercially from 1979 to 1989, but experienced several serious difficulties, which led to low capacity and high costs. In 1986, a settlement agreement between PSCO, the Colorado Public Utilities Commission (CPUC), the Office of the Consumer Counsel (OCC), and other parties led to the removal of FSV from the rate base. PSCO's subsequent decision to retire the reactor was based on several concerns: problems with the control rod drive assemblies and the steam generator ring headers, low plant availability (about 15 percent), and prohibitive fuel costs.\* The reactor was shut down permanently in August 1989, and PSCO became the first commercial nuclear utility to receive a possession-only license from the NRC since the Commission adopted decommissioning rules in 1988.

In April 1991, the Westinghouse Electric Corp. won a \$100-million, fixed-price contract to perform DECON decommissioning at FSV. Project completion is expected by April 1995, including 18 months for project planning (previously initiated) and 39 months for decontamination and dismantlement. As of October 1992, the total estimated decommissioning cost was \$157,472,700, based on the anticipated year of project expenditures and including escalation and utility management costs.<sup>3</sup> Although the FSV nuclear decommissioning trust totaled only \$28 million in October 1992, the CPUC had approved a Supplemental Settlement Agreement in December 1991 allowing PSCO to recover \$124.4 million, plus a 9 percent carrying cost to cover inflation, from rate payers for the remainder of the decommissioning work. Earlier, the CPUC had limited the rate payer liability for FSV decommissioning to \$17.5 million.

Under a Preliminary Decommissioning Plan submitted to the NRC on June 30, 1989, PSCO proposed the SAFSTOR approach. The final plan, however, was submitted November 5, 1990, and proposed the DECON approach. In the interim, PSCO decided to convert the plant to a natural gas-fired generating station and wanted the site available sooner. Moreover, PSCO determined that the economic advantages of SAFSTOR were less impressive when examined in detail. For example, significant LLW volume reductions, and hence cost savings, were not expected for 120 years. Also, PSCO did not want to remain vulnerable to Price-Anderson liability, which is imposed on all licensed commercial nuclear reactors for accidents that occur at any U.S. facility.<sup>4</sup> All nuclear power licensees are subject to a potential maximum liability of \$63 million in case of any major nuclear power industry accident.<sup>5</sup>

<sup>1</sup>The FSV operating license was issued Dec. 21, 1973, and the plant was permanently closed Aug. 18, 1989. The effective operating period, however, was shorter. U.S. Nuclear Regulatory Commission, Office of the Controller, *Information Digest, 1992 Edition*, NUREG-1350, vol. 4 (Washington, DC: March 1992), p. 92.

<sup>2</sup>FSV fuel costs increased substantially, to nearly 60 percent of the total allowed production costs of 4.8 cents per kilowatt hour (kWh) for the unit. Fuel for the next cycle would have cost the utility \$80 million, or approximately 2.8 cents per kWh. At the same time, coal-fired power cost PSCO 2.7 cents per kWh and purchased power only 2.2 cents per kWh. Site Manager, Fort St. Vrain Nuclear Station, Public Service Co. of Colorado, personal communication, Sept. 23, 1992.

<sup>3</sup>Don Warembourg, Public Service Co. of Colorado, "Defueling & Decommissioning Considerations at Fort St. Vrain Nuclear Generating Station," presented at TLG Services, Inc., Decommissioning Conference, Captiva Island, Florida, October 1992. From Thomas S. LaGuardia, President, TLG Engineering, letter to the Office of Technology Assessment, Jan. 22, 1993.

<sup>4</sup>Decommissioning Project Engineer, Fort St. Vrain Nuclear Station, Public Service CO. Of Colorado, personal communication, Sept. 23, 1992.

<sup>5</sup>42 U.S.C. 2210(b)(1).

(Continued on next page)

### Box 4-C-The Fort St. Vrain Decommissioning Project--(Continued)

The FSV DECON project is divided into three major tasks:

1. Decontamination and dismantlement of the prestressed concrete reactor vessel (PCRVR)--the major task.
2. Decontamination and dismantlement of the contaminated balance of plant (BOP) systems.
3. Site cleanup and the final radiation survey.

The total estimated occupational radiation exposure for the project is 433 person-rem: 388 person-rem for PCRVR decontamination and dismantlement, 2 person-rem for BOP decontamination and dismantlement, and 65 person-rem for waste preparation, packaging, shipping, and disposal. (For comparison, the average occupational radiation exposure at operating PWRs in the United States is 288 person-rem and at operating BWRs is 435 person-rem.<sup>6</sup>)

Excluding spent fuel, activation analysis suggests that the total radiation for fixed components is 594,185 curies (Ci) and 199,878 Ci for removable components for a total of 794,083 Ci. Low plant availability and the unique HTGCR design restricted total activation and contamination (For comparison, the total radiation estimated for the reactor vessel in the 1,175 MWe NRC reference PWR reactor after 30 years of operation is 4.8 million Ci.<sup>7</sup>) PSCO estimates that the project will generate 100,072 ft<sup>3</sup> of low-level waste (LLW), which will derive almost entirely (99 percent) from the PCRVR with some contribution (about 1 percent) from the BOP. Most of the LLW is expected to be Class A (70,788 ft<sup>3</sup> or 71 percent) and the remainder Class B (28,293 ft<sup>3</sup>, or 28 percent) and Class C (101 1 ft<sup>3</sup>, or 1 percent).<sup>8</sup>The project is expected to generate no mixed wastes, and there are none onsite.

As an effort to maintain regular contact with the NRC during decommissioning, PSCO asked the agency to retain an onsite inspector for the **duration of the DECON project, as is done for operating plants.** According to officials working with the licensee, however, the NRC denied the request. **At present, NRC decommissioning project managers are located offsite.**

Under a 1985 contract with the DOE, the Idaho National Engineering Laboratory (INEL) agreed to receive FSV spent fuel. INEL previously accepted three of nine spent fuel segments after refueling outages, but the State of Idaho challenged the legality of shipping additional spent fuel to INEL. In the interim, PSCO spent approximately \$2.5 million per month to maintain the unit in its partially defueled condition in accordance with the possession-only license. The company also hired Foster-Wheeler Energy Corp. to build a modular vault dry storage system for the spent fuel onsite at a cost of about \$23 million.

The FSV spent fuel storage facility has a **40-year** design life and houses all the remaining fuel segments, although the liners in the original shipping casks will eventually require changes to gain NRC approval for transport. At present, these casks are certified to store, but not transport, spent fuel. In June 1992, the last of the remaining fuel segments was placed in the **modular vault** dry storage facility, and the NRC approved the PSCO decommissioning plan on November 23, 1992. Active decommissioning began in January 1993.

<sup>6</sup> These figures reflect measured doses in 1989. C.T. Raddatz and D. Hagemeyer, *Occupational Radiation Exposure at Commercial Nuclear Power Reactors and Other Facilities: 1989*, Twenty Second Annual Report, NUREG-0713, vol. 11 (Washington, DC: US Nuclear Regulatory Commission, April 1992), p. B-3.

<sup>7</sup> R. I. Smith, G.J. Konzek, and W.E. Kennedy, Jr., *Battelle Pacific Northwest Laboratory, Technology, Safety and Costs of Decommissioning a Reference Pressurized Water Reactor Power Station*, NUREG/CR-0130, vol. 1 (Washington, DC: U.S. Nuclear Regulatory Commission, June 1978), p. 7-19.

<sup>8</sup> Analytical uncertainties suggest that as much as 400 ft<sup>3</sup> of the Class C LLW may require reclassification as greater-than-Class C (GTCC) waste. GTCC waste is the only form of LLW that is forbidden from near surface burial and requires disposal in a geologic repository. 10 CFR 61.55(a)(2) (iv).

<sup>9</sup> Manager, Fort St. Vrain Radiation Protection, Scientific Ecology Group, Inc., personal communication, Sept. 23, 1992.

ADDITIONAL SOURCES: A. Barrett, "The Big Turnoff," *Financial World*, vol. 160, No. 15, July 23, 1991, pp. 30-32.

"Fort St. Vrain Decommissioning Ready as Nuclear Fuel Removal is completed," *Electric Utility Week*, June 22, 1992, p. 11.

Public Service Company of Colorado, "Notes to consolidated Financial Statements," 1991 Annual Report.

Public Service Company of Colorado, *Proposed Decommissioning Plan for the Fort St. Vrain Nuclear Generating Station*, Nov. 5, 1990.

R.R. Zuercher, "Defueled Fort St. Vrain is Ready for Decommissioning to Begin," *Nucleonics Week*, vol. 33, No. 26, June 25, 1992, pp. 14-15.

R.R. Zuercher, "PSC [PSCO] Gets Go Ahead to Dismantle Fort St. Vrain Gas-Cooled Reactor," *Nucleonics Week*, vol. 33, No. 49, Dec. 3, 1992, pp. 6-7.

U.S. Nuclear Regulatory Commission, "Public Service Co. of Colorado; Issuance of Materials License SNM-2504, Fort St. Vrain Independent Spent Fuel Storage; Installation at the Fort St. Vrain Nuclear Generating Station," 56 *Federal Register* 57539 (Nov. 12, 1991).

and characterizing waste in some storage tanks will be necessary before vitrification and disposal. These are not problems with commercial spent fuel, which is not in liquid form and is not treated or mixed with other wastes. Third, due to HLW liquid releases (both planned and not), an important component of the ERWM program involves soil remediation, which is not expected for commercial decommissioning, except perhaps to remove very low levels of radioactivity, but none of it HLW.<sup>71</sup>

Thus, there are several major differences between commercial nuclear power decommissioning and defense HLW remediation, but Federal cleanup programs are likely to offer some valuable lessons about material decontamination, worker radiation protection, waste packaging, and other related efforts for the commercial nuclear power sector. These lessons are likely to be imparted to private decommissioning contractors and nuclear utilities through the usual means, including published papers and reports, conferences and meetings, and information clearinghouses, including those managed by the Federal Government.

## International Decommissioning Experience

Similar to the United States, international decommissioning experience is limited to very small reactors. Comparing the technical and economic performance of decommissioning between the United States and other nations is complicated by differing regulatory requirements and waste disposal practices, as well as differences in labor costs and international exchange rates. As a result, direct comparisons are difficult, if not impossible.

Based on reactor generating capacity, the largest foreign nuclear power decommissioning projects are Gentilly-1 in Canada (250 MW), Chinon A2 in France (250 MW), Garigliano in Italy (160 MW), and Kernkraftwerk Niederaichbach (KKN) in Germany (100 MW). Table 4-2 lists major foreign decommissioning projects, their status, and estimated costs. For the two current dismantlement projects for which estimates were available (JPDR and KKN), expected costs are greater than Shippingport--between \$120 million and \$140 million (both in 1990 U.S.

<sup>71</sup> For more information about defense HLW cleanup, see U.S. Congress, Office of Technology Assessment, *Long-Lived Legacy: Managing High-Level and Transuranic Waste at the DOE Nuclear Weapons Complex*, OTA-BP-O-83 (Washington, DC: U.S. Government Printing Office, May 1991).

### Box 4-D--The Shoreham Decommissioning Project

On April 21, 1989, the NRC issued the Long Island Lighting Co. (LILCO) a license under 10 CFR Part 50 to operate the 819-MW Shoreham BWR. Two months earlier, on February 28, LILCO and the State of New York had agreed to transfer Shoreham's assets to the State for decommissioning. The utility pursued the full-power license to demonstrate that the reactor was operable. The decision was costly because, by increasing plant radioactivity, the scope and costs of decommissioning increased accordingly. LILCO estimated decommissioning costs of \$186,292,000 (1991 dollars), assuming LLW disposal costs of \$240 per cubic foot. The NRC finds the estimate conservative and acceptable.<sup>1</sup>

Shoreham operated intermittently, at low power, between July 1985 and June 1987. The plant was shut down permanently on June 28, 1989, and the average fuel burnup was calculated to approximate 2 days of full-power operation. Fuel removal was completed in August 1989, and the license was amended to possession-only on July 19, 1991.

The NRC issued the Shoreham decommissioning order June 11, 1992. The order allows LIPA to perform DECON work under the following conditions:

1. Fuel will be completely removed from the site within 6 years (all 560 fuel assemblies are currently in the Spent Fuel Storage Pool in the Reactor Building. As of June 1990, LILCO estimated that the fuel represents roughly 176,000 Curies).
2. Onsite LLW storage will not exceed 5 years.
3. The NRC must approve the installation of a temporary liquid radwaste system referenced in the licensee decommissioning plan.

The total activated inventory at Shoreham is calculated to be a mere 602 Curies. iron-55 and cobalt-60 account for over 97 percent of the activity. The core shroud, top guide plate, and other RPV internals contain over 96 percent of the activated nuclide inventory. Estimated RPV dose rates for shielded workers are between 0.5 and 20 millirems per hour (mrem/hr).

LILCO estimates the entire decommissioning project will produce a total occupational exposure of about 190 person-rem. By comparison, the total occupational exposure for the Shippingport DECON decommissioning project, a 72-MW PWR, was 155 person-rem.<sup>2</sup> Segmenting and removing the Shoreham RPV is estimated to account for 158 person-rem, or 83 percent of the total exposure. By comparison, the average annual exposure at operating BWRs in the United States in 1990 was 436 person-rem.<sup>3</sup> Even though the projected occupational exposures at Shoreham are lower than the average annual exposures at operating BWRs, they are remarkably high relative to Shippingport, where 16,000 curies (more than 25 times the amount of activity at Shoreham) led to less occupational exposure. Unlike Shippingport, however, the Shoreham RPV requires segmentation prior to disposal.

On November 22, 1991, the NRC granted LILCO an exemption from the decommissioning financial assurance provisions under 10 CFR Part 50.75. The short life of the plant prevented the LILCO's existing nuclear decommissioning trust from becoming a viable funding vehicle. The exemption was granted under the following conditions:

<sup>1</sup>U.S. Nuclear Regulatory Commission, *Safety Evaluation by the Office of Nuclear Material Safety and Safeguards Related to the Order Approving the Decommissioning Plan and Authorizing Facility Decommissioning Long Island Power Authority (LIPA) Shoreham Nuclear Power Station, Unit 1, Docket No. 50-322*, June 11, 1992, p. 21. ,

<sup>2</sup>Westinghouse Hanford Company, *Final Project Report: Shippingport Station Decommissioning Project*, DOE/SSDP-0081 (Richland, WA: U.S. Department of Energy, Richland Operations Office, Dec. 22, 1989), p. 13.

<sup>3</sup>Institute of Nuclear Power Operations, "1990 Performance indicators for the U.S. Nuclear Utility Industry" (Atlanta, GA: March 1991).

1. LILCO will provide funds to an external account that would cover 3 months of the projected decommissioning costs.
2. LILCO will maintain a \$10 million external fund to ensure the facility is placed in safe storage if decommissioning is delayed for any reason.
3. NRC will be notified at least 90 days in advance if the LILCO \$300 million line of credit is cancelled or altered.
4. **LILCO will maintain an unused line of credit to cover any remaining decommissioning costs at all times.**

**Shoreham decommissioning will generate an estimated 79,300 cubic feet of solid radioactive waste;** the licensee has determined that the entire quantity of this waste could be stored, if necessary, in the on-site Radwaste Building. All radioactive waste is expected to be Class A waste. No mixed waste is expected from Shoreham decommissioning. Under current plans, the virtually unused fuel at Shoreham will be transferred to the Philadelphia Electric Company's Limerick nuclear power plant by February 1994. The Long Island Power Authority (LIPA), the new operator of the plant, has agreed to pay Philadelphia Electric \$45 million to receive the fuel. LIPA is currently studying options to convert Shoreham to a fossil-fired power station.

ADDITIONAL SOURCES: Long Island Power Authority, *Shoreham Nuclear Power Station Decommissioning Plan*, December 1990.

U.S. Nuclear Regulatory Commission, *Safety Evaluation by the Office of Nuclear Material Safety and Safeguards Related to the Order Approving the Decommissioning Plan and Authorizing Facility Decommissioning Long Island Power Authority (LIPA) Shoreham Nuclear Power Station, Unit 1*, Docket No. 50-322, June 11, 1992.

M. Wald, "Shoreham A-Plant Has Found a Taker For its Spent Fuel," *The New York Times*, Feb. 26, 1993, pp. A1, B4.

R.R. Zuercher, "LiPA to Sign Cogema Contract for Shoreham Fuel Reprocessing," *Nucleonics Week*, vol. 33, No. 49, Dec. 3, 1992, p. 4.

dollars). As with the United States, however, this early experience may indicate little about the future costs and other challenges of decommissioning larger units, particularly as residual radioactivity standards, occupational exposure limits, and waste disposal options may change in the future, both here and abroad.

## ■ Decontamination and Decommissioning (D&D) Technologies

A variety of technologies and approaches to mitigate radiological contamination and to remove activation products from nuclear facilities have been developed. The most important of these are reviewed briefly in this section.

### Decontamination Technologies

The contamination from the partial reactor core melt accident at Three Mile Island Unit 2 in 1979, along with an increasing interest in reducing worker radiation exposures at operating plants in the 1980s, account for much of the development of nuclear plant decontamination methods in the last decade.<sup>72</sup> Decontamination can lower occupational radiation exposures at nuclear plants, lower the chances of unplanned environmental releases, and reduce the final waste disposal requirements when a plant is decommissioned.

Decontamination performance is expressed by a number known as the decontamination factor (DF), which is simply the ratio of the measured radiation field before decontamination to that

<sup>72</sup>J.F. Remark, Applied Radiological Control, Inc., *A Review of Plant Decontamination Methods: 1988 Update*, EPRI NP-6169 (Palo Alto, CA: Electric Power Research Institute, January 1989), p. 1-2.

### Box 4-E-Financing Decommissioning for Early Reactor Retirements

Several commercial nuclear power reactors have retired prior to their license expiration dates. In all cases, the accumulated decommissioning funds have been insufficient to complete the work. However, the mere existence of decommissioning funding shortfalls in cases of early reactor retirement should not cause alarm. Utilities with reactors retired early have already developed plans to cover the remaining funds. A brief synopsis of these plans is given below. Two other recent early retirements (Shoreham and Fort St. Vrain) are the subjects of other boxes in this chapter.

**Three Mile Island.** Three Mile Island Unit 2, a 906-MW pressurized water reactor (PWR), was issued an operating license February 8, 1978, but shutdown due to a partial core melt accident on March 28, 1979. The plant had operated only 1 year. General Public Utilities (GPU) Nuclear Corp. retains its full power operating license but has applied to amend the license to reflect "post defueling monitored storage" (PDMS). GPU intends to maintain Unit 2 this way until Unit 1 is retired and plans to decommission both units as one project. To address Unit 2's post-accident condition, GPU is funding its decommissioning trust at twice the required rate. GPU intends to collect decommissioning funds during the remainder of Unit 2's operating license.

**Rancho Seco.** This 873-MW PWR operated by the Sacramento Municipal Utility District (SMUD) was issued an operating license August 16, 1974, and was shutdown June 7, 1989, by a local voter referendum. The plant had operated almost 15 years. A proposed decommissioning plan is under NRC review and indicates the SAFSTOR approach, partly because the DOE is not scheduled to accept the spent fuel until after 2008. Under current plans, the spent fuel will be moved into dry storage casks, and active decommissioning will begin in 2008. SMUD estimates decommissioning costs of \$281 million (1992 dollars), excluding about \$72 million in spent fuel storage costs and \$12 million in site restoration and other costs—both of which are excluded from NRC financial assurance rules. To fund decommissioning, SMUD will pay \$12 million annually to an external sinking fund. According to the utility, this will provide adequate decommissioning funds by the end of the original license term.

**Yankee Rowe.** This 185-MW PWR was issued an operating license July 1, 1961, and shutdown officially February 26, 1992, 8 years before the expiration of its operating license. (Due to technical concerns, the reactor had been off line since October 1991.) Decommissioning costs are estimated at \$178 million (1992 dollars), excluding \$57 million in spent fuel storage costs and \$13 million in site restoration costs. The estimate, however, includes about \$33 million needed for SAFSTOR preparations. The NRC decommissioning rule requires funding based on a minimum cost of \$138 million (1992 dollars) for Yankee Rowe. Therefore, the current licensee estimate (\$178 million) is 29 percent greater than the NRC financial assurance rules require for the plant. Moreover, this recent utility estimate is about 80 percent greater than a previous estimate (\$98 million) made several years earlier.<sup>1</sup> In 1992, the Yankee Rowe decommissioning trust fund contained approximately \$72 million, and the total shortfall (\$247 million less \$72 million) will be met by contributions from the region's stockholder utilities, earnings on those contributions, and approximately \$32 million in tax refunds. Yankee Atomic Electric Company (YAEC), the plant operator, intends to submit a decommissioning plan to the NRC in late 1993.<sup>2</sup>

**San Onofre.** San Onofre Unit 1 (SONGS-1), a 410-MW PWR operated by Southern California Edison (SCE) Co., began commercial operation January 1, 1968. Pursuant to an agreement with the California Public Utilities Commission (CPUC), SCE retired the plant November 30, 1992, 12 years prior to its license expiration. SCE has tentatively planned SAFSTOR decommissioning, but this is being reevaluated along with a DECON option. A 1990 study estimated decommissioning costs of \$211 million (1990 dollars), but this estimate will be updated as part of the ongoing planning.

<sup>1</sup> "FERC Sets Hearing on Yankee Rowe Shut Down, Decommissioning Costs," *Electric Utility Week*, Aug. 10, 1992, p. 7.

<sup>2</sup> Donald Edwards, Yankee Atomic Electric Corporation, written comments to the Office of Technology Assessment, Jan. 25, 1993.

**Trojan.** The 1,175-MW PWR operated from November 21, 1975, to January 4, 1993—about 17 years. The plant had been off line since November 1992 due to tube leaks in one of its steam generators. The licensee, Portland General Electric (PGE), had earlier decided to close the plant in 1996 rather than pay the estimated \$200 million needed to replace its steam generators. As the major plant owner (67.5 percent), PGE expects to pay \$488 million in 2011 to decommission the unit.<sup>3</sup> A decommissioning plan, with an up-to-date cost estimate, is required within 2 years of final closure under 10 CFR 50.82(a). In particular, the cost revisions eventually submitted by PGE should make an interesting comparison with the one performed by NRC (originally planned for revision this year), because the earlier NRC estimate of Trojan decommissioning was used to develop decommissioning financial assurance requirements for all other PWRs in the United States.

ADDITIONAL SOURCES: ABZ, Inc., "Case Studies of Nine Operating Nuclear Power Plants: Life Attainment, License Renewal and Decommissioning," prepared for the Office of Technology Assessment, February 1993.

P.C. Parshley, D.F. Grosser, and D.A. Roulett, Shearson Lehman Brothers, "Should Investors Be Concerned About Rising Nuclear Plant Decommissioning Costs?" *Electric Utilities Commentary*, vol. 3, No. 1, Jan. 6, 1993, pp. 7-9.

Southern California Edison Company, *Preliminary Decommissioning Plan for the San Onofre Nuclear Generating Station Unit 1*, November 1992, app. B, p. 31; and the Office of Technology Assessment 1993.

U.S. Nuclear Regulatory Commission, Office of the Controller, *Information Digest, 1992 Edition*, NUREG-1350, vol. 4 (Washington, DC: March 1992), pp. 79-93.

<sup>3</sup> "PGE Needs to Buy Supplies to Replace 67% Share of 1,100-MW Trojan Plant," *Electric Utility Week*, Jan. 11, 1993, pp. 12-13; and F. Rose, "Oregon Utility Plans to Close Nuclear Facility," *The Wall Street Journal*, Jan. 5, 1993, p. A4.

after decontamination; a DF of 5, for example, indicates that only one-fifth (20 percent) of the radiation remains on the given plant equipment, surface, or system and that decontamination removed 80 percent. The ultimate level of decontamination will depend on the process used, how and how often it is applied, and where in the facility it is applied. Major decontamination technologies and techniques used in the United States are listed in table 4-3.

Chemical decontamination techniques represent increasingly common methods to reduce occupational radiation exposures at operating commercial nuclear power plants<sup>73</sup> (see ch. 3, box 3-A), and may help reduce plant radiation levels

and occupational exposures during decommissioning. Electropolishing (or electrochemical decontamination) is generally applied to excised or segmented piping and equipment, but it can also be used to decontaminate intact systems. The technique works on a variety of metals and metal alloys, allows material reuse, is relatively quick, and produces a smooth surface (thus inhibiting recontamination from the electrolytic solution).<sup>74</sup>

Physical decontamination is performed with a variety of technologies and techniques, many of them fairly simple. For example, loose, low-level contamination on floors, walls, and other surfaces can be literally vacuumed or swept, while manual scrubbing with simple cleansing compounds can

<sup>73</sup> Ibid., p. 2-9.

<sup>74</sup> H.D. Oak, G.M. Holter, W.E. Kennedy, Jr., and G.J. Konzek, Battelle Pacific Northwest Laboratory, *Technology, Safety and Costs of Decommissioning a Reference Boiling Water Reactor Power Station*, NUREG/CR-0672, vol. 2 (Washington DC: U.S. Nuclear Regulatory Commission, June 1980), pp. G-1, G-3 to G-4.

Table 4-2—Major International Nuclear Power Plant Decommissioning Projects

| Plant   | Design rating and type  | Operational lifetime | Decommissioning approach, schedule, and estimated cost   |
|---|---|----------------------|--|
| Chinon A2 (France)  | 250-MW, gas-cooled, graphite-moderated reactor                              | 1964-85              | Stage 1 (1986 to 1992) estimated at \$39.9 million (1990 U.S. dollars). Dormancy of at least 50 years prior to Stage 3 (dismantlement).      |
| Garigliano (Italy)  | 160-MW, dual-cycle BWR  | 1964-78              | Stage 1 (1985 to 1995) for main containment estimated at \$54.8 million (1990 U.S. dollars). Dormancy of at least 30 years prior to Stage 3. |
| Gentilly-1 (Canada)   | 250-MW, heavy-water moderated, boiling light-water cooled prototype reactor | 1970-79              | Variant of Stage 1 (1984 to 1986) estimated  |
| Japan Power Demonstration Reactor (JPDR)                      | 45-MW BWR   | 1963-76              | Stage 3 (1986 to 1993) estimated at \$143 million (1990 U.S. dollars). Estimate includes site restoration.                                   |
| Kernkraftwerk Niederaichbach (KKN) (Germany)                  | 100-MW, heavy-water moderated, gas-cooled reactor                           | 1972-74              | Stage 3 (1987 to 1994) estimated at \$121.4 million (1990 U.S. dollars).   |
| Windscale Advanced Gas Cooled Reactor (WAGR) (United Kingdom) | 33-MW, gas-cooled reactor   | 1962-81              | Stage 3 (1983-1998). No current cost estimate available.   |

NOTE: The international decommissioning staging numbers are descriptive, and there may be some overlap between stages. In general, Stage 1 involves placing a unit into extended storage for later dismantlement, and activities include plant and equipment sealing and extended routine surveillance; Stage 2 involves partial decontamination and dismantlement, allowing re-use of non-radioactive plant areas; Stage 3 is final dismantlement, where all materials and areas with radiation above regulatory levels are decontaminated or removed.

SOURCES: Organisation for Economic Co-Operation and Development, Nuclear Energy Agency, *International Co-Operation on Decommissioning: Achievements of the NEA Co-operative Programme, 1985-1990* (Paris, France: 1992); Organisation for Economic Co-Operation and Development, Nuclear Energy Agency, *Decommissioning of Nuclear Facilities: An Analysis of the Variability of Decommissioning Cost Estimates* (Paris, France: 1991); and S. Yanagihara and M. Tanaka, "Estimating the Costs for Japan's JPDR Project," *The Energy Journal*, vol. 12, Special Issue, 1991, p. 146.

also remove superficial contamination.<sup>75</sup> Other methods, including mechanical devices, are available to remove more tenacious contamination, including high-pressure sprays (water, freon), grit blasters, steam cleaners, strippable coatings, and ultrasonic cleaners. Furthermore, specialized robots can be used to perform work in high radiation or otherwise inaccessible areas.

## DISMANTLEMENT TECHNOLOGIES

With the exception of specialized robots used to perform tasks in high radiation fields or other difficult plant areas, the technologies used to decommission nuclear plants are generally applied in innovative ways rather than being innovative themselves. In general, the same technologies used to dismantle other structures, such as build-

<sup>75</sup> Ibid., p. G-5.



Table 4-3-Major Decontamination Technologies and Techniques in the United States

| Chemical decontamination  |  |  |
|---|--|--|
| Technology  | Decontamination factors (DFs) <sup>a</sup> | Comments   |
| CITROX (citric and oxalic acid)                                     | 4 to 15                                    | Recirculating, regenerative method. Contains oxalic acid, which may corrode some system components. Used in about 20 percent of reactor decontamination at operating U.S. units (PWRs and BWRs).   |
| CAN-DEREM (citric acid with ethylenediamine-tetraacetic acid, EDTA) | 5 to 16                                    | Recirculating, regenerative method. Lacks oxalic acid and thus safe for system components under normal conditions. Original mixture included oxalic acid (CAN-DECON), which is still in regular use. Generally applied to operating BWRs.  |
| LOMI (low oxidation state metal ion)                                | 2 to 61                                    | Recirculating or single-loop, non-regenerative method. Safe to reactor components. Used in BWRs more often than PWRs. The most widely used chemical decontamination technique since 1985.  |
| <b>Electrochemical polishing (electropolishing)</b>                 | —  | As with conventional methods, electropolishing may decontaminate systems in situ, eliminating the need for cutting (if desired). Generates hydrogen, an explosive gas that must be ventilated.   |
| Strippable coatings   | 5 to 20                                    | Best with less adherent contamination. May also be used to coat surfaces prior to work. All associated waste is solid and resulting volumes are low. Most applications require manual removal.   |
| Water jets (high and ultra-high pressure)                           | 3 to 20 (high-pressure water jet)          | High pressure water jets (up to 10,000 pounds per square inch) work only with loose contamination; ultra-high jets (20,000 to 60,000 psi) work well with tenacious contamination. Abrasive grits added to better the DFs. Useful for decontaminating inaccessible areas. High volumes of waste may be generated and contamination may be spread if removed material is not captured. |
| Robots and robotic devices  | Variable                                   | This is a broad category of technologies. Workable in greatly confined work spaces, high radiation areas, and may supplement other technologies. Includes rotating water jet nozzles, mobile concrete spallers, and other often unfunctional devices.  |

<sup>a</sup> Decontamination factors (DFs) will vary greatly, depending on the type and level of contamination, how the chemicals are applied (concentration, temperature, duration, and number of flushes) and, especially, the systems or components treated (e.g., reactor water cleanup system, reactor coolant pumps, steam generators, spent fuel pool).

**SOURCES:** H.D. Oak, G.M. Helter, W.E. Kennedy, Jr., and G.J. Konzek, Batelle Pacific Northwest Laboratory, *Technology, Safety and Costs of Decommissioning a Reference Boiling Water Reactor Power Station*, NUREG/CR-0672, vol. 2 (Washington, DC: U.S. Nuclear Regulatory Commission, June 1980), pp. G-3 to G-5; C.J. Wood and C.N. Spalaris, *Sourcebook for Chemical Decontamination of Nuclear Power Plants*, EPRI NP-6433 (Palo Alto, CA: Electric Power Research Institute, August 1989), pp. 1-1 to 2-1 0; J.F. Remark, Applied Radiological Control, Inc., *A Review of Plant Decontamination Methods.* 1988 Update, EPRINP-6169 (Palo Alto, CA: Electric Power Research Institute, January 1989); and H. Ocken and C.J. Wood, *Radiation-Field Control Manual—1991 Revision*, EPRITR-100265 (Palo Alto, CA: Electric Power Research Institute, 1992), pp. 6-1 to 6-26.

ings, bridges, and fossil-fired power plants, are being used for maintenance and repairs at operating reactors and may be used to dismantle them as well: plasma arc and acetylene torches, electric saws, controlled explosives, remote cutting devices, jackhammers, and specialized robots. Major decommissioning technologies and their functions are listed in table 4-4.

## ESTIMATING COSTS AND RADIATION EXPOSURES

Decommissioning cost estimates and radiation exposure projections developed well in advance of reactor retirements are subject to several major uncertainties, including the nature and extent of plant and site radioactivity at final closure, local labor rates, waste disposal costs, and applicable radiation standards during dismantlement. As a result, cost estimates vary depending on a site and its conditions, but their reliability will tend to improve the closer a plant is to actual decommissioning. The same is true with projections of radiation exposures. Over the last several years, the technical ability to estimate the costs and radiation exposures from decommissioning has improved considerably; although a few methodological uncertainties remain, estimates should improve with experience,

If viewed as a one time expense, decommissioning costs of several hundred million dollars may appear large but are far less significant compared to the life cycle costs of an operating plant. Current estimates suggest that decommissioning costs will represent only about 1 percent of the total generating costs over a plant's life.<sup>76</sup>

Moreover, a doubling or tripling of current estimates would have a minimal effect on generating costs, raising them between one and three mills per kilowatthour.<sup>77</sup>

News stories and other reports about decommissioning projects often fail to distinguish nominal (undiscounted) costs from real (discounted) costs, particularly those claiming decommissioning costs will exceed \$1 billion per reactor.<sup>78</sup> In real terms, current decommissioning cost projections are in the range of several hundred million dollars—not \$1 billion or more. As decommissioning will generally occur at least 40 to 60 years after plant construction, the future nominal costs may appear much larger, but the major reason is generally inflation calculated over time. For example, real decommissioning costs for the 1,150-MW Seabrook PWR in New Hampshire are estimated at \$324 million (1991 dollars), but the nominal costs when dismantlement is expected to begin in 35 years are estimated at \$1.6 billion (2026 dollars), which accounts for inflation and trust fund earnings.<sup>79</sup> Any effort, therefore, to compare costs for power plant projects over time should consider the discounted value of resources to reduce the potential for confusion.

Definitions of decommissioning that differ from those in NRC rules, which focus only on remediating radioactive portions of a plant, may lead to differing expectations among State and local governments and the public about what the task involves and its cost. For instance, complete plant dismantlement and site restoration may intuitively seem like basic elements in “decommissioning” any nuclear or non-nuclear

<sup>76</sup> Organisation for Economic Co-Operation and Development Nuclear Energy Agency, *Decommissioning of Nuclear Facilities: An Analysis of the Variability of Decommissioning Cost Estimates* (Paris, France: 1991), pp. 7, 10.

<sup>77</sup> A mill is a unit commonly used to express electricity production costs and represents one-tenth of one cent. The estimate here assumes an original decommissioning estimate of \$200 million and a 1,000 MWe reactor operating 25 years at a 70 percent capacity factor. Under these circumstances, decommissioning cost increases to \$400 million (doubling) or \$600 million (tripling) would raise the costs of each kilowatthour generated over the period roughly 1.3 and 2.6 mills, respectively, assuming constant dollars.

<sup>78</sup> See, for example, R. Johnson and A. De Rouffignac, “Closing Costs: Nuclear Utilities Face Immense Expenses In Dismantling Plants,” *The Wall Street Journal*, Jan. 25, 1993, pp. A1, A9.

<sup>79</sup> R.R. Zuercher, “Seabrook Decommissioning Fund Case Goes To New Hampshire High Court,” *Nucleonics Week*, vol. 33, No. 22, May 28, 1992, pp. 2-3.

Table 4-4—Major Decommissioning Technologies and Their Functions

| Technology   | Application  | Comments (pros/cons)  |
|--|--|---|
| Arc saw  | Segment activated metal; segment piping, tanks, and other metal.                             | Workable on all metals; usable in air or underwater; remote operations/needs adequate space for blade; significant smoke generation.  |
| Plasma arc torch   | Segment activated metal; segment piping, tanks, and other metal.                             | Workable on all metals; usable in air or underwater; remote or portable operations/lower thickness than arc saw; need contamination control and standoff space behind tool.   |
| Oxygen burner  | Segment activated metal; segment piping, tanks, and other metal.                             | Usable in air or underwater; remote or portable operations/limited to carbon steel; generates radioactive fumes.  |
| Thermic lance  | Segment activated metal; segment piping, tanks, and other metal; cuts all types of concrete. | Workable on all metals; usable in air or underwater; portable operations; well-suited for irregular surfaces/remote operations difficult; needs ventilation; requires molten metal removal; use underwater produces bubbles, which obscures visibility. |
| Controlled explosives  | Segment activated metal; segment piping, tanks, and other metal; cuts all types of concrete. | Workable on all metals and reinforced concrete; usable in air or underwater; remote or portable operations/limited cutting thickness; explosion may affect mechanical integrity and may scatter radioactive material and dust.                          |
| Mechanical nibbler and shear; hydraulic shear                                      | Segment activated metal; segment piping, tanks, and other metal.                             | Workable on all metals; usable in air or underwater; remote or portable operations/usable only for thin metal pieces and pipes.   |
| Hacksaws, guillotine saws, mechanical saws, circular cutters, and abrasive cutters | Segment piping, tanks, and other nonactivated metals.  | Workable on all metals; varying degrees of portable and remote uses/slow cutting; small to medium-thickness; space, contamination, smoke, and other problems may apply.   |
| Diamond wire saw   | Non or minimally reinforced concrete (walls, floors).  | Use not limited by concrete thickness/wire requires water cooling; generates contaminated dust and water.   |
| Concrete spaller   | Surface concrete removal (spalling).   | Thin- to medium-section spalling; allows large structures to remain intact; no explosions needed; minimal dust generation/difficult with irregular surfaces and limited space.  |
| Abrasive water jet   | Nonreinforced concrete (walls, floors).  | Thin-section spalling/voluminous generation of contaminated water.  |

SOURCES: Organisation for Economic Co-Operation and Development, Nuclear Energy Agency, International Co-Operation on Decommissioning: Achievements of the NEA Co-operative Programme, 1985-1990, (Paris, France: 1992), pp. 116-1 19; and H.D. Oak, G.M. Helter, W.E. Kennedy, Jr., and G.J. Konzek, Batelle Pacific Northwest Laboratory, Technology, Safety and Costs of Decommissioning a Reference Boiling Water Reactor Power Station, NUREG/CR-0672, vol. 2 (Washington, DC: U.S. Nuclear Regulatory Commission, June 1980), pp. G-1 to G-22.

facility, but these tasks are not generally necessary to eliminate the radiological hazard at a nuclear power site. NRC rules also exclude spent fuel removal, storage, and disposal from decommissioning funding requirements, although radiological decommissioning cannot be completed until all fuel is removed.<sup>80</sup> Moreover, some States may require nonradiological dismantlement, including site restoration, suggesting that the narrow definition of decommissioning in NRC rules excludes other potential expenses licensees may incur or the public may expect when nuclear plant sites are remediated.

### ■ Methods for Estimating Decommissioning costs

To illustrate the relative financial magnitude of decommissioning, some observers have compared these costs with plant construction costs.<sup>81</sup> However, comparing decommissioning costs with plant construction costs may be misleading. Each set of costs is partially related to reactor size, but factors more important than size have determined the costs for each. Key determinants of decommissioning costs are operational history, occupational and residual radiation standards, and waste generation and disposal requirements—not construction costs or much related to them. With regard to construction costs, interest payments on loans and project delays (not reactor size) have historically led to substantial differences; more than 60 percent of Shoreham con-

struction costs, for example, stemmed from interest on construction loans.<sup>82</sup> As a result, the costs either to construct or decommission two similar reactors may each vary greatly, depending upon historical financial and operating circumstances. In many cases, therefore, comparing construction and decommissioning costs is inappropriate.

The history of construction cost estimation, however, provides a cautionary lesson to decommissioning planners to avoid sanguine expectations that dismantling increasingly large reactors will provide major economies of scale and economies of learning, two assumptions that failed to bear out with construction experience.<sup>83</sup>

### COSTING METHODS

There are several basic approaches used to estimate decommissioning costs. The least rigorous approach assumes a direct proportional relationship between decommissioning cost and unit size for all reactors. With this approach, the ratio of decommissioning cost to plant size (measured by power output) for a completed project is applied to another plant of known size to estimate its decommissioning cost. For example, the 58-MWt (22.5-MW) Elk River BWR was DECON decommissioned in 1974 at a cost then of \$6.15 million. Applying its cost-to-size ratio (roughly \$106,000 per MWt) to a standard-sized 3,300-MWt (1,100-MW) reactor planning DECON suggests that the larger reactor would cost \$350

---

<sup>80</sup> Within 5 years of license expiration+ NRC rules require commercial nuclear power licensees to submit preliminary decommissioning plans, which must indicate licensee plans to fired spent fuel management until the DOE accepts the fuel for final disposal. 10 CFR 50.54(bb). Until the 5-year mark, however, assuming the licensee is able to plan shut down that far in advance, there are no financial assurance requirements to address spent fuel management storage, or disposal. The only decommissioning financial planning required during the entire license term, therefore, is for reactor dismantlement, not spent fuel costs.

<sup>81</sup> See, for example, G.R.H. Fry, "The Cost of Decommissioning U.S. Reactors: Estimates and Experience," *Nuclear Decommissioning Economics: Estimates, Regulation, Experience and Uncertainties*, M.J. Pasqualetti and G.S. Rothwell (eds.), *The Energy Journal*, vol. 12, Special Issue, 1991, pp. 93, 97; and D. Borson, Public Citizen Critical Mass Energy Project, *Payment Due: A Reactor-by-Reactor Assessment of the Nuclear Industry's \$25+ Billion Decommissioning Bill* (Washington, DC: Public Citizen, Oct. 11, 1992), p. 79.

<sup>82</sup> Thomas S. LaGuardia, President, TLG Engineering, letter to the Office of Technology Assessment, Jan. 22, 1993.

<sup>83</sup> R. Cantor, "Applying Construction Lessons to Decommissioning Estimates," *Nuclear Decommissioning Economics: Estimates, Regulation, Experience and Uncertainties*, M.J. Pasqualetti and G.S. Rothwell (eds.), *The Energy Journal*, vol. 12, Special Issue, 1991, pp. 105-117.

million (1974 \$) to decommission.<sup>84</sup> Though conservative and unreliable, the proportional approach provides a quick, crude estimate of the potential cost to decommission a given plant.

To improve the crude estimates generated from simple proportional calculations, the unit cost factor approach was developed under the auspices of the Atomic Industrial Forum in the 1970s to provide a more systematic examination of likely decommissioning costs to help set appropriate utility rates. The approach determines unit costs for the range of tasks (e.g., cutting and packaging pipe of a given size) necessary to decommission plant systems, and the unit costs are adjusted according to assumptions about work difficulty (expressed as quantitative “difficulty factors”) and performance times. Total cost is the product of the number of unit operations multiplied by their associated unit costs. The same method is used to determine cumulative radiation doses.

The challenge with the unit cost approach is determining reasonable difficulty factors, which some contend may currently be too conservative (i.e., large) and require refinement.<sup>85</sup> Experience with decommissioning one or more large commercial reactors should provide critical information about the appropriateness of current difficulty factors used in unit cost estimates. The unit cost approach is commonly used in the private sector, particularly by one firm (TLG Engineering, Inc. ) that has provided site-specific estimates for more than 90 U.S. commercial nuclear power reactors.<sup>86</sup>

Another basic approach used to estimate decommissioning costs is the **detailed engineering** method. This approach is based on in-depth

reviews of specific existing operating plants to determine labor requirements, radiation doses, efficient work schedules, and costs. This approach was used by Battelle Pacific Northwest Laboratory (PNL) in developing estimates for the NRC reference reactors, which are the basis of the Federal decommissioning financial assurance figures.<sup>87</sup> Both methods (unit cost factor and detailed engineering) are used extensively today. There is no current consensus on the more reliable approach, but both methods are likely to improve with actual decommissioning experience at a few large reactors, including Shoreham and Fort St. Vrain.

There is no reliable method to project labor costs many years in advance, because work difficulty, worker productivity, and project scheduling will vary with time and changing conditions. Variables such as local labor rates, available labor pools, training costs, radiation exposure and monitoring requirements, technological performance, and plant contamination levels are generally more speculative the further a licensee is from the commencement of decommissioning work. With time, any of these variables could increase or decrease final decommissioning costs.

Current database programs, which are used in both unit cost factor and detailed engineering analyses, provide detailed records of plant inventories and contaminated equipment and materials; these programs determine unit cost factors fairly easily for simple, repetitive tasks. The challenge, however, arises with more complicated tasks, particularly the dismantlement of steam generators and reactor pressure vessels. The reliability of

---

<sup>84</sup> R.I. Smith, “Generic Approaches to Estimating U.S. Decommissioning Costs,” *Nuclear Decommissioning Economics: Estimates, Regulation, Experience and Uncertainties*, M.J.Pasqualetti and G.S.Rothwell (eds.), *The Energy Journal*, vol. 12, Special Issue, 1991, p. 150. Note: This paper uses the phrase “linear extrapolation” to describe the proportional method of calculating decommissioning costs.

<sup>85</sup> *Ibid.*, pp. 1s0-152.

<sup>86</sup> Thomas LaGuardia, president, TLG Engineering, Inc., comments delivered during NRC public meeting in Arlington, VA, May 6, 1993.

<sup>87</sup> R.I. Smith, “Generic Approaches to Estimating U.S. Decommissioning Costs,” *Nuclear Decommissioning Economics: Estimates, Regulation, Experience and Uncertainties*, M.J.Pasqualetti and G.S.Rothwell (eds.), *The Energy Journal*, vol. 12, 1991, Special Issue, pp. 152-153.

cost estimation for this more complex work will improve with more decommissioning experience.

Several other key uncertainties hamper current costing models. First, scheduling and other time-dependent assumptions in current models were developed from experience with smaller dismantlement projects and may be inappropriate for larger plants. Second, the macroeconomic supply and demand impacts on costs are not addressed in current models. For example, utility planners generally assume stable unit costs for dismantlement work, disregarding the potential market impacts of other decommissioning projects commencing in the same period.<sup>88</sup> Third, current models cannot reliably predict whether major economies of scale or other benefits of experience may occur when larger reactors are dismantled.<sup>89</sup>

In sum, future experience decommissioning large reactors should improve cost estimation considerably, but current uncertainties in determining the actual costs to dismantle large (more than 50 MW) commercial reactors will probably remain so for at least another decade, if not longer, because no large reactors with operational lives more than a few years have been dismantled yet nor are likely to be soon. Some current uncertainties with decommissioning cost estimation reflect unresolved Federal policies and standards, including final standards for residual radioactivity. Lingering questions about both HLW and LLW disposal siting, capacity, and costs also prevent plant operators from making reliable final estimates of total

decommissioning costs. Labor and project scheduling assumptions used in current cost models may also change with more experience dismantling larger plants, including their large components such as reactor pressure vessels. The ultimate impact of such potential changes on total costs remains speculative.

## ■ Decommissioning Cost Estimates

A 1991 national survey of decommissioning cost estimates for large operating reactors determined an average of \$211 per kilowatt (kW), with a standard deviation of \$96 per kW (both in 1989 dollars). The average estimate for the 47 PWRs surveyed was \$191 per kW (standard deviation of \$65 per kW), and \$248 per kW (standard deviation of \$126 per kW) for the 26 BWRs surveyed.<sup>90</sup> These figures suggest that decommissioning a 1,000-MW plant would cost about \$211 million (1989 dollars), based on existing estimates, although the standard deviation is substantial (\$96 million).

These aggregate cost figures have two major limitations. First, as discussed above, comparing estimated costs with plant size can be misleading, because plant size is neither the single, nor best, measure of potential decommissioning costs. Second, the relatively narrow range of these estimates may reflect an artificial uniformity, because most were derived from TLG and PNL models.<sup>91</sup> However, the results provide simple averages of current decommissioning cost estimates.

---

<sup>88</sup> R. Cantor, "Applying Construction Lessons to Decommissioning Estimates," *Nuclear Decommissioning Economics: Estimates, Regulation, Experience and Uncertainties*, M.J. Pasqualetti and G.S. Rothwell (eds.), *The Energy Journal*, vol. 12, Special Issue, 1991, p. 108.

<sup>89</sup> See G.R.H. Fry, "The Cost of Decommissioning U.S. Reactors: Estimates and Experience," *Nuclear Decommissioning Economics: Estimates, Regulation, Experience and Uncertainties*, M.J. Pasqualetti and G.S. Rothwell (eds.), *The Energy Journal*, vol. 12, Special Issue, 1991, pp. 87-104. Examining the limited U.S. decommissioning experience to date, Fry argues that there appear to be few or no economies of scale. However, the analysis includes two reactors (Fermi Unit 1 and Three Mile Island Unit 2) that experienced partial core meltdowns, thus obscuring what may be a trend of decreasing cost with size for reactors without such major accidents. Fry concludes that more experience will be necessary to confirm whether or not scale economies will develop for large decommissioning projects.

<sup>90</sup> P.M. Strauss and J. Kelsey, "State Regulation of Decommissioning Costs," *Nuclear Decommissioning Economics: Estimates, Regulation, Experience and Uncertainties*, M.J. Pasqualetti and G.S. Rothwell (eds.), *The Energy Journal*, vol. 12, Special Issue, 1991, pp. 56-64.

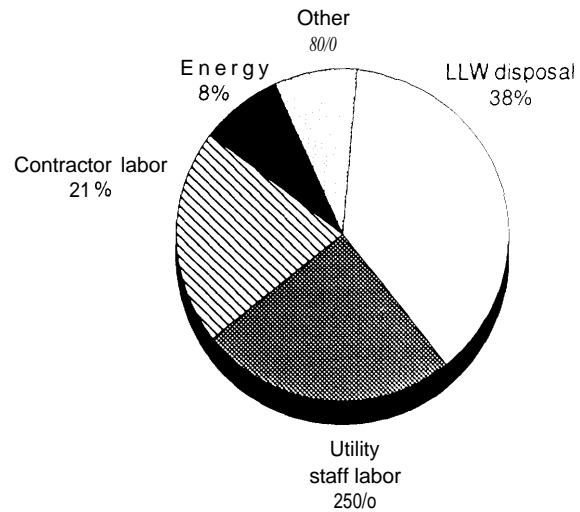
<sup>91</sup> *Ibid.*, pp. 60-63.

A series of NRC studies, using the PNL model, has examined the potential costs to decommission U.S. commercial reactors by examining two units in detail. These studies are detailed engineering analyses of the 1,175-MW Trojan Unit 1 PWR (Prescott, Oregon) and the 1,155-MW Washington Nuclear Project (WNP) Unit 2 (Richland, Washington) (the “reference reactors”). The estimates vary depending on the reactor type (PWR or BWR) and decommissioning approach. In brief, DECON decommissioning using an external contractor for labor and management assistance was projected to cost \$103.5 million for the reference PWR and \$131.8 million for the reference BWR (both in 1986 dollars, assuming a 25 percent contingency).<sup>92</sup>

The major elements of the reference PWR and BWR cost estimates are waste shipment and disposal, labor, and energy (figures 4-6 and 4-7).<sup>93</sup> For both estimates, supplies, equipment, and other items account for the remainder of costs. Both estimates *exclude* spent fuel disposal, nonradiological decommissioning, and site restoration costs, because these activities are excluded from the NRC definition of decommissioning.

The lack of demonstrable progress in developing a national MRS facility or a geologic repository, however, suggests that more commercial nuclear power licensees will need to build and operate interim spent fuel storage facilities. This will add waste management costs of at least \$20 million to \$30 million per plant, representing about 10 to 20 percent of expected dismantlement costs. In some cases, interim spent fuel storage will cost far more. Moreover, LLW volume

**Figure 4-6--Major Costs From Decommissioning a Reference Pressurized Water Reactor**



**SOURCE:** G.J. Konzek and R.I. Smith, Battelle Pacific Northwest Laboratory, *Technology, Safety and Costs of Decommissioning a Reference Pressurized Water Reactor Power Station: Technical Support for Decommissioning Matters Related to Preparation of the Final Decommissioning Rule*, NUREG/CR-0130, Addendum 4 (Washington, DC: U.S. Nuclear Regulatory Commission, July 1988), p. 3.1.

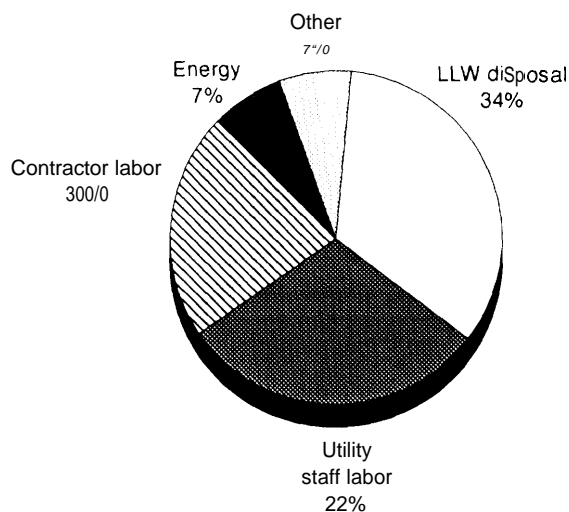
projections from decommissioning will remain somewhat speculative until either the NRC or the EPA promulgates residual radioactivity standards. In addition to NRC requirements, licensee plans or State requirements may introduce additional nonradiological decommissioning costs, perhaps including site restoration.

The key differences between current decommissioning cost estimates generally center on the two major cost elements—labor and waste disposal. In general, the NRC reference studies project lower labor requirements, lower LLW

<sup>92</sup> The DECON approach is assumed for financial planning, because it is considered the most expensive option. As noted earlier, however, the use of DECON (immediate dismantlement) may not be viable for many (if not most) light water reactors due to spent nuclear fuel cooling requirements, which currently prevent fuel removal from storage pools for at least 5 years. As a result, plant-specific analyses will be necessary to determine the minimum period of safe storage prior to decommissioning. George J. Konzek, Sr., Senior Research Engineer, Pacific Northwest Laboratories, letter to the Office of Technology Assessment, Jan. 8, 1993.

<sup>93</sup> G.J. Konzek and R.I. Smith, Battelle Pacific Northwest Laboratory, *Technology, Safety and Costs of Decommissioning a Reference Pressurized Water Reactor Power Station: Technical Support for Decommissioning Matters Related to Preparation of the Final Decommissioning Rule*, NUREG/CR-0130, Addendum 4 (Washington DC: U.S. Nuclear Regulatory Commission, July 1988), p. 3.1; and G.J. Konzek and R.I. Smith, Battelle Pacific Northwest Laboratory, *Technology, Safety and Costs of Decommissioning a Reference Boiling Water Reactor Power Station: Technical Support for Decommissioning Matters Related to Preparation of the Final Decommissioning Rule*, NUREG/CR-0672, Addendum 3 (Washington DC: U.S. Nuclear Regulatory Commission, July 1988), p. 3.1.

**Figure 4-7—Major Costs From Decommissioning a Reference Boiling Water Reactor**



**SOURCE:** G.J. Konzek and R.I. Smith, Battelle Pacific Northwest Laboratory, *Technology, Safety and Costs of Decommissioning a Reference Boiling Water Reactor Power Station: Technical Support for Decommissioning Matters Related to Preparation of the Final Decommissioning Rule*, NUREG/CR-0672, Addendum 3 (Washington, DC: U.S. Nuclear Regulatory Commission, July 1988), p. 3.1.

volumes, and hence lower costs than most site-specific industry estimates.<sup>94</sup> For example, an independent industry analysis of the NRC reference BWR estimates that DECON decommissioning (using the NRC definition) will cost \$201.5 million (1987 dollars), about 46 percent more than the \$138 million (1987 dollars) projected in the PNL study. While the industry analysis estimated LLW generation of 24,489 m<sup>3</sup>, a 29 percent increase over the NRC figure, this difference accounted for a minor portion of the

cost difference. Instead, the most significant difference between the estimates, about \$40 million, was labor costs.<sup>95</sup> Field experience from future dismantlement projects will eventually help test the reliability of the methods underlying these estimates.

Under contract with the NRC, PNL is revising both reference reactor cost estimates. Although no report has been finalized, the revised PWR cost estimate is currently \$124.6 million (1993 dollars), about \$5 million less when adjusted to the original (1986) dollars. The report authors attribute the cost decrease to LLW volume reductions but also acknowledge many of the excluded costs (e.g., spent fuel management) and other uncertainties (e.g., absence of residual radioactivity standards, LLW disposal costs). This estimate could more than double when the excluded costs and the other uncertainties are considered.<sup>96</sup>

## ■ The Impacts of Life Extension on Decommissioning Costs

The impacts of license renewal on decommissioning are a likely deferral of dismantlement work, a slight increase in final plant radioactivity levels, and the disposal of any major equipment replaced during the renewal term (e.g., PWR steam generators, BWR turbine blades). A 1991 PNL study estimated the impacts on decommissioning costs of extending operations of the reference reactors by 20 years and assumed that some major equipment (RPV and internals) would need replacement.<sup>97</sup> Even under this unlikely scenario of RPV replacement, the estimates

<sup>94</sup> P.M. Strauss and J. Kelsey, "State Regulation of Decommissioning Costs," *Nuclear Decommissioning Economics: Estimates, Regulation, Experience and Uncertainties*, M.J. Pasqualetti and G.S. Rothwell (eds.), *The Energy Journal*, vol. 12, Special Issue, 1991, pp. 60-63.

<sup>95</sup> G.J. Konzek and R.I. Smith, Battelle Pacific Northwest Laboratory, *Technology, Safety and Costs of Decommissioning a Reference Boiling Water Reactor Power Station: Comparison of Two Decommissioning Cost Estimates Developed for the Same Commercial Nuclear Reactor Power Station*, NUREG/CR-0672, Addendum 4 (Washington, DC: U.S. Nuclear Regulatory Commission, December 1990), pp. 2.5, 2.10.

<sup>96</sup> E. Lane, "PNL Study Cuts Cost Estimate For Nuclear Decommissioning," *The Energy Daily*, vol. 21, No. 123, June 29, 1993, p. 3.

<sup>97</sup> R.I. Smith, Battelle Pacific Northwest Laboratory, "Potential Impacts of Extended Operating License Periods on Reactor Decommissioning Costs," PNL-7574 (Richland, WA: Battelle Pacific Northwest Laboratory, March 1991). All material in this section is from the PNL report.



indicated that extended operations would minimally affect final decommissioning costs, adding about \$2 million (1986 dollars) to dismantle each reactor. However, the analysis was limited to GTCC disposal costs and assumed that replacing the RPV and internals during the extended license term would account for the major increase in decommissioning costs (aside from PWR steam generator replacement). The study estimated that most of the estimated cost increase could be eliminated by high-density packaging of the GTCC waste, a procedure not considered in the original PNL reference reactor analyses.

In the original reference PWR and BWR analyses, LLW disposal represented the largest single cost. On the basis of uncertainty, however, the life extension study did not estimate future LLW disposal costs but indicated that new compact sites could charge as much as \$100 to \$200 per cubic foot (excluding surcharges) by the year 2000. A key determinant of potential future costs, therefore, was excluded. The impacts of other uncertainties (e.g., labor cost escalation and future residual radioactivity standards) were not examined.

### ■ Estimating Radiation Exposures for Decommissioning

The human health and environmental challenge during decommissioning is to hold radiation exposures as low as possible. This section reviews the results of modelling estimates of collective radiation doses from decommissioning. In addition, the section summarizes predicted or measured doses from several actual steam generator replacement and reactor decommissioning projects. Radiation standards during decommissioning (10 CFR Part 20) are the same that apply during plant operations (see ch. 2). Although the NRC does not set collective dose standards, the measurement is used to compare

the aggregate exposures for different tasks (e.g., decommissioning) conducted at nuclear facilities.<sup>98</sup>

#### COLLECTIVE DECOMMISSIONING DOSE: PROJECTIONS BASED ON THE NRC REFERENCE REACTORS

The collective doses projected for decommissioning the two NRC reference reactors are given in figures 4-8 and 4-9. The values differ significantly, depending on the reactor type (greater collective dose for BWRs generally), decommissioning approach (greatest collective dose for DECON), and the length of time work is deferred (lowest collective dose for 100-year SAFSTOR).

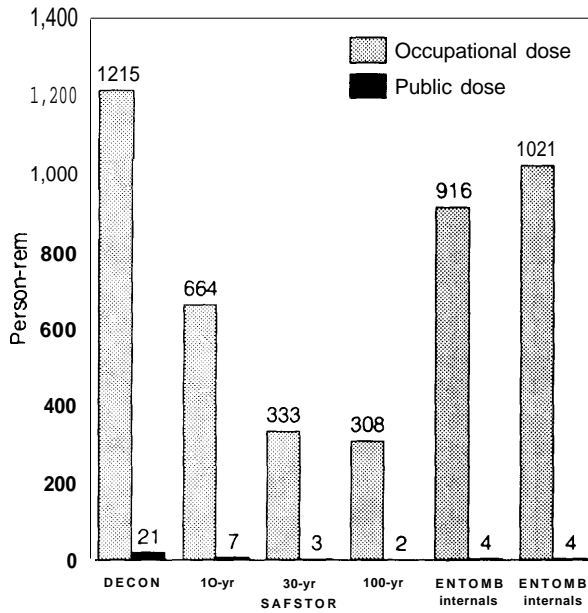
In brief, BWRs are single-loop systems that channel reactor cooling water in the form of steam directly to the turbines, leading to greater contaminant dispersion and thus explaining the higher projected doses for decommissioning. For the same reason, BWRs also produce greater collective doses than PWRs during normal operations. In addition, more plant radioactivity decays the longer decommissioning is deferred, explaining why 100-year SAFSTOR produces the lowest collective doses and DECON the highest. (This study projected that ENTOMB yielded greater collective doses than SAFSTOR, because the former method was assumed to involve more decontamination and some partial dismantlement earlier than the SAFSTOR scenarios.)

The NRC projections suggest that the annual collective occupational doses associated with decommissioning are very similar to those experienced while plants are in operation, even in the worst dose scenario (four-year DECON). The DECON estimates represent an annual average PWR dose of about 279 person-rem and an annual average BWR dose of about 440 person-rem. By comparison, the average annual occupational

---

<sup>98</sup> The major limitation with collective exposure numbers is that they are averages; the variation in individual exposures, no matter how significant, is not indicated by this number, and individual or collective radiation risks cannot be determined by this number either. It is merely a gross measure of the average individual exposure in an affected group.

**Figure 4-8-Collective Radiation Doses From Decommissioning a Reference Pressurized Water Reactor**



SOURCE: U.S. Nuclear Regulatory Commission, Office of Nuclear Regulatory Research, *Final Generic Environmental Impact Statement on Decommissioning of Nuclear Facilities*, NUREG-0586 (Washington, DC: August 1988), pp. 4-8.

dose at operating PWRs in the United States in 1990 was 294 person-rem and 436 person-rem at operating BWRs.<sup>99</sup>

Collective public dose from decommissioning is minimal compared to collective occupational dose. Under all scenarios, for both PWRs and BWRs, collective public dose derives almost entirely from the truck shipments of radioactive waste to the disposal facilities. Projections of collective occupational doses, on the other hand, for DECON and 10-year SAFSTOR are principally from decontamination activities, while most

occupational doses for 30- and 100-year SAFSTOR stem from activities associated with storage preparations.<sup>100</sup>

#### COLLECTIVE DOSE: OTHER PROJECTIONS AND RELATED EXPERIENCE

Limited but useful information from actual decommissioning and nuclear plant maintenance projects suggests the relative radiological impacts expected from future decommissioning work. The Shippingport decommissioning project, for example, disposed of 16,000 Ci and resulted in a collective occupational exposure of 155 person-rem, only 15 percent of the 1,007 person-rem projected during decommissioning planning. Shippingport decommissioning project management attributes the lower occupational dose to ALARA (as low as reasonably achievable) planning and coordination. However, by not segmenting the RPV, which contained over 99 percent of the disposed curies, project planners unquestionably eliminated much of the expected occupational dose at Shippingport.<sup>101</sup>

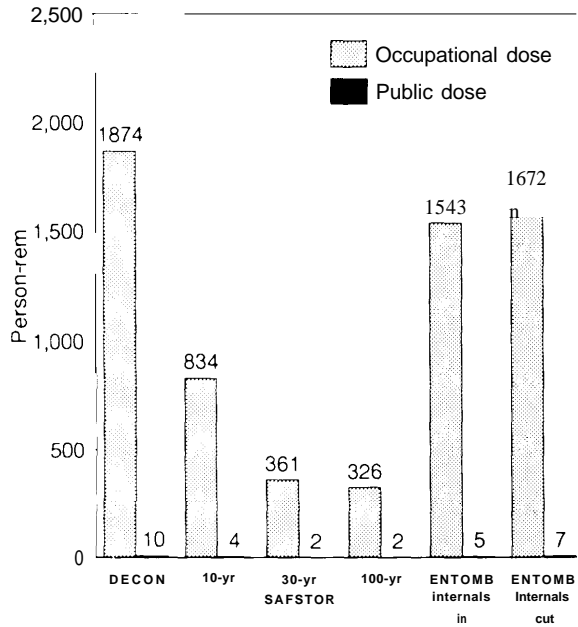
Unless other technologies or techniques such as metal melting are applied in the future, RPV segmentation is likely to be the norm for most commercial nuclear power plant decommissioning work, and this will increase decommissioning exposures considerably relative to Shippingport. At both Fort St. Vrain (box 4-C) and Shoreham (box 4-D), RPV dismantlement is expected to account for most of the occupational exposures but, like Shippingport, the radiation at these units was almost entirely present in their RPVs; this will not be the case with larger units that operate longer.

<sup>99</sup> Institute of Nuclear Power Operations, "1990 Performance Indicators for the U.S. Nuclear Utility Industry" (Atlanta, GA: March 1991).

<sup>100</sup> U.S. Nuclear Regulatory Commission, Office of Nuclear Regulatory Research, *Final Generic Environmental Impact Statement on Decommissioning of Nuclear Facilities*, NUREG-0586 (Washington DC: August 1988), pp. 4-8,5-8.

<sup>101</sup> RPV segmentation was part of the original Shippingport decommissioning plan. Westinghouse Hanford Company, *Final Project Report: Shippingport Station Decommissioning Project*, DOE/SSDP-0081 (Richland, WA: U.S. Department of Energy, Richland Operations Office, Dec. 22, 1989), pp. 13,48.

**Figure 4-9—Collective Radiation Doses From Decommissioning a Reference Boiling Water Reactor**



SOURCE: U.S. Nuclear Regulatory Commission, Office of Nuclear Regulatory Research, *Final Generic Environmental Impact Statement on Decommissioning of Nuclear Facilities*, NUREG-0586 (Washington, DC: August 1988), pp. 5-8.

Collective occupational radiation exposures measured from recent steam generator replacements at U.S. operating plants have been as high or higher than the NRC projections of average annual DECON exposures (table 4-5). As these figures suggest, exposures from major maintenance activities at operating commercial plants are comparable to expected decommissioning exposures and therefore represent common, generally accepted levels of risk.

### REACTOR RETIREMENT AND FINANCIAL REQUIREMENTS

Beyond estimating decommissioning costs, a challenge remains to collect reasonable decommissioning funds while a unit is still operating, rather than later when electricity production has ceased. In cases of early reactor retirement, decommissioning funding shortfalls may be sig-

**Table 4-5—Occupational Radiation Exposures From Recent Steam Generator Replacements**

| Unit (year of replacement)       | Net capacity (MWe) | Total exposure (person-rem) |
|----------------------------------|--------------------|-----------------------------|
| H.B. Robinson 2 (1984 ).. . . .  | 739                | 1,207                       |
| Cook 2 (1988) . . . . .          | 1,133              | 561                         |
| Indian Point 3 (1989). . . . .   | 1,013              | 540                         |
| Palisades (1990). . . . .        | 805                | 487                         |
| Millstone 2 (1993 ).... . . . .  | 889                | 650                         |
| North Anna 1 (1993 ).... . . . . | 947                | 240                         |

SOURCES: North Anna data from R.R. Zuercher, "Virginia Power Sets World Record For Steam Generator Replacement," *Nucleonics Week*, vol. 34, No. 15, Apr. 15, 1993, pp. 1, 11; Millstone data from R.R. Zuercher, "NU Restarts Millstone-2 Following Extended Steam Generator Outage," *Nucleonics Week*, vol. 34, No. 3, Jan. 21, 1993, pp. 6-7; all other data from H. Hennicke, "The Steam Generator Replacement Comes of Age," *Nuclear Engineering International*, vol. 36, No. 444, July 1991, p. 23.

nificant (box 4-E), although the costs of unrecovered plant capital will often match or exceed the remaining decommissioning liability (see ch. 3) and thus introduce larger impacts on consumer electricity rates than decommissioning shortfalls. This section reviews the major regulatory issues relating to decommissioning and its financing, including relevant NRC requirements, funding options, and the performance of existing funds. Although the NRC has established minimum funding levels to plan for decommissioning, state utility commissions have the major role in determining the actual timing, amounts, and other conditions of decommissioning financing.

None of the three general decommissioning approaches (DECON, SAFSTOR, or ENTOMB) is the obvious choice for most decommissioning work, and NRC rules do not dictate which option to use. The approach chosen by licensees will depend on site-specific conditions, including the availability and costs of LLW disposal facilities, the economic potential and regulatory requirements for later site use, and the particular need or urgency (if any) to eliminate the potential environmental and financial liability that a contaminated site represents. For purposes of financial planning, most commercial nuclear power licen-

sees assume they will DECON decommission,<sup>102</sup> but recent data suggest that DECON may not be viable for many light water reactors.<sup>103</sup> And although numerous small research reactors have undergone ENTOMB decommissioning, the NRC considers its technical viability for large commercial plants limited.<sup>104</sup> As a result, under current regulations and technical specifications, most U.S. commercial power reactors are likely to complete decommissioning within a period ranging from 5 to 60 years after they retire.

### ■ Terminating an Operating License

Under NRC rules, commercial nuclear power licensees must apply for the termination of their operating licenses within 2 years after permanent shutdown and in no case later than 1 year before license expiration. If not submitted earlier, a proposed decommissioning plan must accompany an application for license termination. Proposed plans must describe the decommissioning approach, procedures to protect occupational and public health and safety, and an updated cost estimate.<sup>105</sup> A license may not be terminated until the site is remediated and a final radiation survey performed.

A variety of safety requirements that apply to operating reactors become unnecessary once operations cease permanently. In recognition of that, NRC Regulatory Guide 1.86 allows plant operators to apply for an amended operating license that allows plant possession only. A “possession-only license” (POL) exempts plant operators from a variety of costly operating requirements, including requirements applied to emergency core cooling systems (10 CFR 50.46), in-service inspection (10 CFR 50.55a(g)), and reactor fracture toughness against pressurized thermal shock (10 CFR 60.61).<sup>106</sup>

With an approved POL, licensees may forego NRC annual operating fees, which amount to roughly \$3 million per unit.<sup>107</sup> The saved resources may be used for other work, such as decommissioning planning and execution, but there are no current standards and guidelines that specify the format of POL applications. As a result, such applications are developed on a case-by-case basis.<sup>108</sup> By issuing standards and guidance clarifying the role of and application process for POL status, the NRC would help ensure that post-closure licensee activities and costs are reasonably minimized and that final

<sup>102</sup> P.M. Strauss and J. Kelsey, “State Regulation of Decommissioning Costs,” *Nuclear Decommissioning Economics: Estimates, Regulation, Experience and Uncertainties*, M.J. Pasqualetti and G.S. Rothwell (eds.), *The Energy Journal*, vol. 12, Special Issue, 1991, pp. 56-65. Of course, deferring plant dismantlement (the SAFSTOR approach) would reduce significantly the amount of LLW necessary for disposal, but there are other costs (license fees, security, taxes, insurance) and uncertainties (potential changes to waste disposal capacity, disposal costs, or regulatory release criteria) associated with deferring dismantlement.

<sup>103</sup> The use of DECON (immediate dismantlement) may not be viable for many (if not most) light water reactors due to spent nuclear fuel cooling requirements, which currently prevent fuel removal from storage pools for at least 5 years. As a result, plant-specific analyses will be necessary to determine the minimum period of safe storage prior to decommissioning. George J. Konzek, Sr., Senior Research Engineer, Pacific Northwest Laboratories, letter to the Office of Technology Assessment Jan. 8, 1993.

<sup>104</sup> U.S. Nuclear Regulatory Commission, Office of Nuclear Regulatory Research, *Final Generic Environmental Impact Statement on Decommissioning of Nuclear Facilities*, NUREG-0586 (Washington, DC: August 1988), pp. 2-6 to 2-12. For large reactors with long operational lives, the ENTOMB approach is not likely to ensure sufficient decay of long-lived radioisotopes within reasonable periods (e.g., 100 years) to allow site release.

<sup>105</sup> 10 CFR 50.82.

<sup>106</sup> Nuclear Management and Resources Council, Inc., *Regulatory process for Decommissioning Prematurely Shutdown Plants*, NUMARC 92-02 (Washington, DC: November 1992), p. 4-4.

<sup>107</sup> 10 CFR 171.15.

<sup>108</sup> Nuclear Management and Resources Council, Inc., *Regulatory Process for Decommissioning Prematurely Shutdown Plants*, NUMARC 92-02 (Washington, DC: November 1992), p. 4-1.

decommissioning planning and execution could begin as expeditiously and safely as possible.

### ■ NRC Financial Assurance Requirements

NRC financial assurance rules are designed to ensure that sufficient funds are available to decommission nuclear plants even if the licensee defaults.<sup>109</sup> Although the default of an electric utility is rare, decommissioning financial assurance is considered necessary, because electric utilities are typically private, investor-owned firms that are vulnerable, as any other firm, to insolvency. In addition, if the salvage value of a power plant exceeded its expected cleanup costs, the need for financial assurance requirements would be less compelling, but potential salvaging revenues for nuclear plants are limited (perhaps a few tens of millions of dollars at best) relative to decommissioning costs (a few to many hundreds of millions of dollars).

Under NRC rules, the *minimum* financial assurance that licensees must provide to decommission each of their reactors is determined by a sliding scale that considers primarily the type and size (as measured in MWt) of a reactor.<sup>110</sup> In 1986 dollars, the minimum financial assurance for decommissioning a PWR ranges from roughly \$86 million for the smallest reactors to \$105 million for the largest, and the minimum financial assurance for a BWR ranges from roughly \$115 million to \$135 million.<sup>111</sup> These regulations contain additional requirements to adjust annually the escalations in labor, energy, and LLW burial costs<sup>112</sup> (the most significant components of decommissioning expenses). Utilities are required to perform but not report these adjustments.

### ■ Adequacy of NRC Financial Assurance Requirements

The NRC maintains that the amounts in the financial assurance rule are not decommissioning cost estimates but rather provide a reasonable approximation of the *minimum* costs of decommissioning. In the Supplementary Information to its 1988 decommissioning rule, the NRC suggested that the financial assurance provisions should provide the *bulk* (not necessarily all) of the funds needed to decommission commercial nuclear plants in the United States.<sup>113</sup> In that respect, though, the amounts represent an actual (though perhaps minimum) estimate.

The NRC financial assurance rules establish finding levels for commercial power plants in each reactor class (PWR or BWR) by adjusting primarily for size. While these rules are based on detailed engineering studies of two reference reactors, the generic approach may not be satisfactory for providing reliable financial assurance for the entire industry given the significant differences in individual reactor designs, operating histories, eventual plant contamination, and other factors that will be more important than size in determining final decommissioning costs at many (if not most) commercial nuclear power plants in the United States.

A simple understanding of plant size may not be sufficient to predict *or* plan financially for total project costs, if plant design, final contamination, and other site conditions have more important impacts on decommissioning costs than reactor size. Compared to site-specific decommissioning estimates performed for several recently retired reactors (box 4-E), the NRC requirements are consistently and substantially low.

---

<sup>109</sup> 53 *Federal Register* 24018-24056 (June 27, 1988).

<sup>110</sup> The capacity of an electrical generating plant can be expressed in MWe (electrical capacity) or MWt (thermal capacity). The NRC decommissioning financial assurance requirements are based on MWt, which is considered a better indication of physical plant size. MWe, on the other hand, is a measure of the efficiency of power conversion which can change over time without any changes to plant size.

<sup>111</sup> 10 CFR 50.75(C)(1).

<sup>112</sup> 10 CFR 50.75(c)(2).

<sup>113</sup> 53 *Federal Register* 24030 (June 27, 1988).

Furthermore, the current regulatory definition of decommissioning and the related NRC financial assurance rules under 10 CFR 50.75 exclude spent fuel disposal, its associated costs, and other potential nonradiological expenses (e.g., site restoration) that States may require. As plant decommissioning cannot be completed before all spent fuel is removed, the current regulatory distinction between spent fuel waste disposal and other decommissioning activities is arbitrary and masks the range of activities and costs needed to complete “decommissioning,” even as defined by NRC rules. As previously discussed, the costs of providing any needed interim storage for spent fuel can be substantial, about \$20 million to \$30 million per plant, which is in the range of 10 to 20 percent of the current estimates of radiological decommissioning.

Post-closure costs such as plant maintenance and inspection, security, property taxes, insurance, and remaining license fees may be significant as well but are also excluded from NRC decommissioning financial assurance requirements, which focus on removing site radiological contamination. As a result, radiological decommissioning is only one part (although perhaps the most important) of post-closure expenses at commercial nuclear power plants, but future changes to NRC financial assurance rules could include some of these other costs, such as spent fuel management, plant maintenance and monitoring, insurance, and site security.

There appears to be widespread agreement among utilities, State public utility commissions (PUCs), and even the NRC that the reference reactor decommissioning cost estimates underlying the NRC financial assurance rules are low. The NRC is currently updating its studies of the reference reactors, one of which (Trojan) retired this January. In the meantime,

utilities and PUCs have relied increasingly on site-specific cost estimates to prepare for eventual decommissioning; most licensees, in fact, now use site-specific estimates. Thus, the future benefit of revising the generic NRC financial assurance formulae may be negligible. Encouraging licensees to develop and update regularly their own site-specific decommissioning cost estimates may have more value in assuring adequate financing than actually revising the regulatory figures in 10 CFR 50.75.

NRC rules require licensees to submit a preliminary decommissioning plan and cost estimate about 5 years prior to expected plant retirement.<sup>114</sup> However, the licensees of all seven reactors that retired early in the last 14 years had far less than five years to plan for their respective reactor retirements, suggesting that this generic requirement may also have little practical value in assuring adequate decommissioning financing.

#### EARLY REACTOR RETIREMENT

The recent trend of early nuclear power plant retirements undermines the basic NRC objective that licensees have available sufficient decommissioning funds at final shutdown, an objective expressed as part of the 1988 rule.<sup>115</sup> With early retirement, the operating period assumed for the collection of decommissioning funds is reduced, often substantially. Collections for decommissioning trusts are calculated assuming a unit operates its full licensed life. The average life, however, of the seven retired reactors was less than 15 years. Excluding arguable anomalies such as Three Mile Island and Shoreham, both of which shut down after a year or less of operations, the average life of the remaining five plants was only 20 years, half the time assumed in standard license periods. These early retirements highlight

---

<sup>114</sup> 10 CFR 50.75(f). This rule does not specifically require a site-specific estimate.

<sup>115</sup> 53 *Federal Register* 24031 (June 27, 1988).

the need to re-examine the NRC financial assurance requirements to ensure that adequate decommissioning resources are available (or assured) whenever a plant closes. Also, as discussed in chapter 3, the allocation of decommissioning costs among current and future consumers and utility shareholders is an issue for which there is limited precedence.

#### FUNDING REQUIREMENTS FOR EARLY REACTOR RETIREMENT

In 1992, the NRC promulgated a rule to address decommissioning funding for reactors retired prior to their license expiration. Recognizing that licensees generally have access to significant financial capital, the NRC decided to determine the need for accelerated funding based on case-by-case determinations of licensee financial conditions.<sup>116</sup>

These requirements are based on two basic principles stated in the preamble to the rule. One, all decommissioning funds should be collected before the original operating license term expires. Two, licensees may collect funds during any storage period, but only until the license expiration date and only if they maintain a bond rating of at least “A” or equivalent by Moody’s Investment Services, Standards and Poors, or another national rating agency. If licensee bond ratings fall below the “A” screening criterion more than once in a 5-year period, the balance of decommissioning funds may have to be collected and deposited into an external account within 1 year of the downrating, unless other criteria that reasonably assure financial solvency are met.<sup>117</sup>

There are several potential problems with the decommissioning financial assurance rules as applied in cases of early retirement. First, linking bond rating to fund accumulation may effectively

eliminate SAFSTOR as a financially attractive decommissioning alternative by potentially limiting the period in which funds may be collected. Second, the rule may create a disincentive to close uneconomic plants out of concern to collect sufficient decommissioning funds during operations. Third, requiring licensees to collect the remainder of any funding shortfall precisely when their bond ratings drop may aggravate further their financial position, without substantially improving the prospects of collecting all decommissioning funds. Finally, these rules may assure adequate funding for eventual decommissioning, but they do not prevent future ratepayers from paying the bulk of decommissioning costs.

#### POST-ACCIDENT PREMATURE DECOMMISSIONING INSURANCE

In 1991, insurance became available to cover the costs of premature decommissioning from severe accidents that cause property claims to exceed \$500 million. Both of the two nuclear excess property insurers provide coverage. Nuclear Electric Insurance Limited (NEIL), an industry-sponsored organization, will cover the difference between the amount in the decommissioning trust fund and final target up to the pre-selected sublimit. (The current maximum is \$200 million, which is expected to increase to \$250 million.) American Nuclear Insurers and Mutual Atomic Energy Liability Underwriters (ANI/MAELU), pools of commercial insurers, will indemnify decommissioning costs to a “greenfield” condition, once other decommissioning funds are exhausted, up to \$100 million.<sup>118</sup>

#### FUNDING REQUIREMENTS IN OTHER NATIONS

Official decommissioning funding requirements in other nations vary considerably, and many are

<sup>116</sup> 57 Federal Register 30383-30387 (July 9, 1992). See 10 CFR 50.82(a).

<sup>117</sup> These other criteria include an evaluation of the licensee’s financial history, local and State regulatory conditions, the number of its Other nuclear and non-nuclear generating plants, and other factors deemed relevant by the NRC. 57 Federal Register 30385 (July 9, 1992).

<sup>118</sup> ABZ, Inc., “Case Studies of Nine Operating Nuclear Power Plants: Life Attainment, License Renewal and Decommissioning, contractor report prepared for the Office of Technology Assessment February 1993, p. 52.

far less rigorous than NRC requirements. The governments of Germany, Italy, and the United Kingdom have not imposed decommissioning funding requirements, although German plant operators make voluntary financing arrangements. The Canadian government requires nuclear operators to arrange decommissioning financing but does not specify actual amounts or funding methods. Finland, Spain, and Sweden have decommissioning funding requirements but, unlike the United States, monies are collected from operators by their respective governments and managed in separate national funds. In France, the government-owned utility adjusts its accounts monthly to help finance future decommissioning based on the product of reactor capacity (size) multiplied by 15 percent of the construction costs of a reference 1,300-MW PWR. In Japan, where 85 percent of collected fund monies are tax-free, utilities determine decommissioning funds based on the estimated weight of dismantled plant wastes.<sup>119</sup>

## ■ Funding Options

By July 1990, NRC licensees were required to submit reports indicating their plans to provide reasonable financial assurance for decommissioning.<sup>120</sup> These reports had to specify the type and amount of financial assurance provided, using either site-specific cost estimates or the NRC regulatory minimum given in 10 CFR 50.75(c). Three general types of financial assur-

ance are eligible: prepayment; an external sinking fund; or a surety method, insurance, or other guarantee.

Prepayment, as the word suggests, involves depositing sufficient cash or other liquid assets prior to facility operations into an account maintained separately from licensee assets to fund decommissioning. Prepayment may be in the form of a trust, escrow account, government fund, certificate of deposit, or deposit of government securities.<sup>121</sup> An external sinking fund is also maintained separately from licensee assets, but payments are made at least annually during operations rather than in advance. External fund investments may be the same as those for prepayment.<sup>122</sup> The last decommissioning option—a surety method, insurance, or other guarantee method—may be in the form of a surety bond, a letter of credit, or a line of credit, but any surety method used must remain effective until the NRC terminates the license.<sup>123</sup> Most licensees use an external fund to finance decommissioning.<sup>124</sup> The choice is understandable: prepayment is expensive, requiring a licensee to collect all decommissioning monies in advance and, until recently, no decommissioning surety options were available on the market.

## QUALIFIED AND NONQUALIFIED EXTERNAL FUNDS

Before 1984, any funds collected for decommissioning were federally taxed. By 1986, statutory changes allowed Federal tax deductions for

<sup>119</sup> Organisation for Economic Co-Operation and Development, Nuclear Energy Agency, *Decommissioning of Nuclear Facilities: An Analysis of the Variability of Decommissioning Cost Estimates* (Paris, France: 1991), pp. 104-108.

<sup>120</sup> 10 CFR 50.33(k).

<sup>121</sup> 10 CFR 50.75(e)(1)(i).

<sup>122</sup> 10 CFR 50.75 (e)(1) (ii), (e)(3)(@).

<sup>123</sup> in 10 CFR 50.75(1)(iii), (e)(1) (hi)(C) Until 1990, many licensees maintained internal decommissioning accounts to control better their financial management, but concerns about the loss of these funds in cases of utility insolvency led the NRC to eliminate this option. 53 *Federal Register* 24033 (June 27, 1988).

<sup>124</sup> "Outlook On Decommissioning Costs," *Nucleonics Week*, Sept. 27, 1990, Special Report, p. 5. This review examined documents filed for 68 nuclear plants.



any decommissioning funds placed in qualified investments (public debt securities and bank deposits). Decommissioning funds may be invested in other securities, but they are ineligible (nonqualified) for corporate tax deductions and, until recently, faced the full corporate tax rate of 34 percent. Nonqualified funds, such as mutual funds, are higher risk investments that generally earn more than qualified funds—even accounting for their greater tax burden. Nonetheless, most decommissioning monies are invested in qualified funds.<sup>125</sup>

In recent years, many investment managers and utility analysts have argued that earnings from many qualified investments, though relatively safe financially, have not performed well, some barely (if at all) earning more than inflation.<sup>126</sup> Although monies placed in qualified funds have been tax deductible, their earnings were taxed at the full corporate rate of 34 percent. Moreover, disbursements from qualified funds were taxed at the full corporate rate, reducing substantially the benefits of their qualified status. At the same time, even though nonqualified fund monies were taxed, their disbursements were not, increasing substantially their stature as an investment option. Concerns about trust fund earnings recently prompted Congress to repeal the investment restrictions on qualified external funds and reduce their applicable tax rates to 22 percent in 1994 and 20 percent starting in 1996.<sup>127</sup> At present, nuclear

decommissioning trusts (NDTs) total an estimated \$5 billion to \$7 billion, with an estimated 80 percent invested in municipal bonds. The recent congressional changes, however, are likely to shift many investments to other, higher yielding securities.<sup>128</sup>

## B Performance of Existing Funds

In 1990, the Critical Mass Energy Project of the nongovernmental group Public Citizen surveyed the status of existing NDTs. Their findings suggest that commercial nuclear power licensees are not collecting decommissioning funds quickly enough. The group determined that less than 14 percent of the total sum of all projected U.S. nuclear power plant decommissioning costs had been collected, even though more than 33 percent of their expected operational lives had passed (assuming neither life extension nor premature retirement).<sup>129</sup> However, with compounded interest earnings, net NDT growth will accelerate in later years. In addition, the NRC financial assurance rules were not effective until 1990, but the Public Citizen findings are a reminder that many licensees had operated their plants 10 years or longer before the NRC rule became effective, and many licensees will have to accelerate their collection schedules. The report also found that about one-third (34 percent) of decommissioning funds remained in internal funds in 1990.<sup>130</sup>

---

<sup>125</sup> H. Hiller, "Investment Strategies for Nuclear Decommissioning and Pension Funds: Highlighting the Differences," Salomon Brothers, Inc., Bond Portfolio Analysis: Nuclear Decommissioning, Apr. 14, 1989, p. 5.

<sup>126</sup> See, for example, P.C. Stimes and R.T. Flaherty, "Investment Management for Nuclear Decommissioning Trusts," *Public Utilities Fortnightly*, vol. 126, No. 11, Nov. 2, 1990, pp. 32-33; and M.D. Weinblatt, S. D'Elia, and T.A. Haven, "Choosing Investment Strategy for Qualified Nuclear Plant Decommissioning Trusts," *Public Utilities Fortnightly*, vol. 122, No. 10, Nov. 10, 1988, pp. 33-36.

<sup>127</sup> Energy Policy Act of 1992, Public Law 102-486, 106 Stat. 3024-3025, Sec. 19 17.

<sup>128</sup> J. Pryde, "Nuclear Decommissioning Funds Are Unlikely To Fully Eliminate Municipal, Analysts Say," *The Bond Buyer*, vol. 302, No. 29021, Nov. 3, 1992, p. 1.

<sup>129</sup> D. Borson Public Citizen Critical Mass Energy Project, *Payment Due: A Reactor-by- Reactor Assessment of the Nuclear Industry's \$25+ Billion Decommissioning Bill* (Washington, DC: Public Citizen, Oct. 11, 1992), p. 2.

<sup>130</sup> *Ibid.*, p. 3.

# Case Studies of Nine Operating Plants

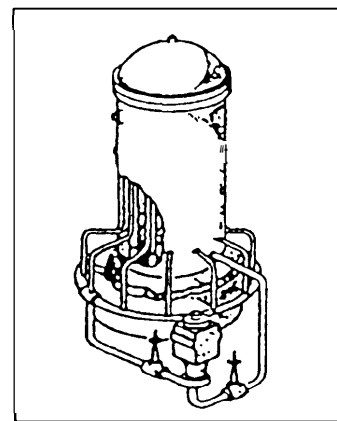
# 5

In order to learn in detail some of the current plans, activities, costs, and other issues related to commercial nuclear power plant life attainment, life extension, and decommissioning, the Office of Technology Assessment supported a study to examine five sites with nine operating plants.<sup>1</sup> This chapter is adapted from that study. The issues examined were performance and operating history, plans and activities towards license renewal, and current plans for decommissioning. The selected units span a wide range of ages, sizes, and designs, reflecting the diversity of the 108 nuclear power plants operating in the United States today.

The first step was to select plants for review that were representative of the diversity of U.S. nuclear power plants and that had experience with life attainment, license renewal, and decommissioning. To capture some of the diversity in plant designs, reactors from three of the four commercial nuclear suppliers were chosen. General Electric exclusively supplies boiling water reactors (BWRs), while there are three suppliers of pressurized water reactors (PWRs), Westinghouse, Combustion Engineering, and Babcock and Wilcox.

In addition, plants with a range of power capacities and ages were selected. A number of older plants, such as Oyster Creek and San Onofre Unit 1, were designed and constructed before substantial experience was obtained with commercial nuclear power. These older plants do not have the same kinds of systems and equipment found in larger and more *recently* constructed plants, but some face early decommissioning or life extension decisions now.

<sup>1</sup> ABZ, Inc., "Case Studies of Nine Operating Nuclear Power Plants: Life Attainment, License Renewal and Decommissioning," contractor report prepared for the Office of Technology Assessment, February 1993.



Under these considerations, the five sites selected were Calvert Cliffs, Hope Creek, Monticello, Salem, and the San Onofre Nuclear Generating Station (SONGS). Calvert Cliffs is a two-unit site with 845 megawatt-electric (MWe) Combustion Engineering reactors that both began operations in the mid-1970s. Salem is also a two-unit site, but with Westinghouse reactors, each rated at 1,106 MWe. Salem Unit 1 began operation in June 1977, and Unit 2 began operation in October 1981. The start delay between the units was caused primarily by the performance of upgrades (backfits) required after the accident at Three Mile Island Unit 2.

Hope Creek is a 1,031-MWe General Electric reactor that began operation in December 1986. The unit is a fourth generation BWR with enhanced safety features similar to the most current (sixth) generation. Earlier BWR designs such as Oyster Creek and Nine Mile Point Unit 1 are second and third generation units. The majority of BWRs are fourth and fifth generation plants similar to Hope Creek. Monticello is a third generation BWR and, until recently, was the industry's lead plant for license renewal. In terms of systems and design, Monticello is reasonably representative of the later BWR product line built in the 1970s.

The SONGS site has three units. SONGS Unit 1 is one of the first Westinghouse PWRs; the unit went on line in 1967 and was retired in 1992 pursuant to an agreement with the California Public Utilities Commission. SONGS Units 2 and 3 are larger, Combustion Engineering plants that went into service in the mid-1980s.

Despite an abundance of publicly available information, many details about commercial nuclear power plants contained in Federal Government and other reports are missing, elusive, or difficult to interpret. For example, detailed breakdowns of utility operations and maintenance

(O&M) expenses are not publicly available and would be difficult to reconstruct; consequently, significant additional research and analysis would have been necessary to understand in detail the underlying causes for the rise in O&M costs over the past several years at these plants. In addition, the U.S. Nuclear Regulatory Commission (NRC) ranks operating plant performance by systematic assessment of licensee performance (SALP) scores, which range from 1 (good) to 3 (needs improvement). The impact of SALP scores on utility management is difficult to quantify, because the link between scores and subsequent corrective actions is difficult to trace with publicly available data.

## CALVERT CLIFFS CASE STUDY<sup>2</sup>

### ■ Performance and Operating History

The Baltimore Gas and Electric Co. (BG&E) in Maryland owns and operates two nuclear power units at its Calvert Cliffs site. Both units are 845-MWe PWRs constructed by Bechtel. The nominal 40 year license period for both units has been established, recovering the time used for construction. BG&E applied for this extension in June 1984, and the NRC approved in May 1985. The recovered time used during construction enables both units to operate a total of 12 reactor-years beyond their original license periods. This action is consistent with industry practice. A summary of the construction and licensing history for Calvert Cliffs is listed in table 5-1.

Records indicate that BG&E operated both units at Calvert Cliffs in an above average manner until the late 1980s, with good reliability and safety records. Lifetime capacity factors for both units equal or slightly exceed industry averages. With the exception of scheduled outages, Calvert Cliffs did not experience significant outages until

<sup>2</sup>Unless noted otherwise, all information in the discussion of this plant is from personal communication between Baltimore Gas and Electric Co. (BG&E; Barth Doroshuk), ABZ, Inc. (Edward Abbott and Nick Capik), and the Office of Technology Assessment (Robin Roy and Andrew Moyad) on, and subsequent to, June 9, 1992.

**Table 5-1—Calvert Cliffs Construction and Licensing History**

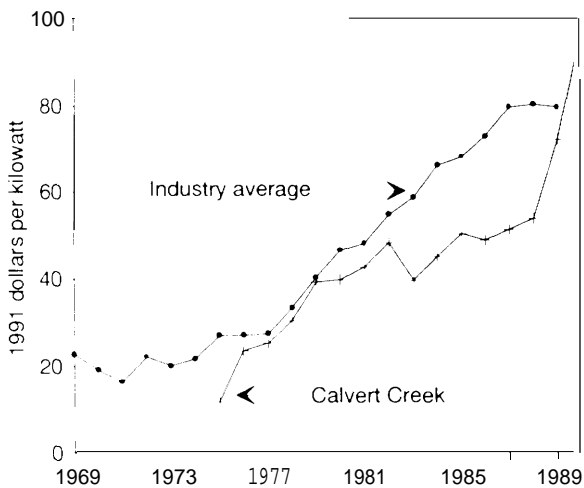
|                  | Date of construction permit | Construction cost (year of expenditure, in millions) | Operating license start date | Commercial operation | License expiration | Lifetime capacity factor |
|------------------|-----------------------------|--|------------------------------|----------------------|--------------------|--------------------------|
| Unit 1 . . . . . | July 1969                   | \$428.7  | July 1974                    | May 1975             | July 2014          | 67 percent               |
| Unit 2 . . . . . | July 1969                   | \$329.7  | November 1976                | April 1977           | April 2016         | 70 percent               |

SOURCE: ABZ, Inc., "Case Studies of Nine Operating Nuclear Power Plants: Life Attainment, License Renewal and Decommissioning," contractor report prepared for the Office of Technology Assessment, February 1993

1989. BG&E held its operating and maintenance costs below the industry average until the late 1980s (figure 5- 1). With the exception of backfits performed between 1980 and 1983—largely in response to the Three Mile Island (TMI) accident—there were no major capital additions at Calvert Cliffs (figure 5-2). Other NRC performance indicators for Calvert Cliffs are summarized in table 5-2 (values are for both units combined). The lack of significant safety issues until the late 1980s helped BG&E maintain operating costs significantly below the industry average.

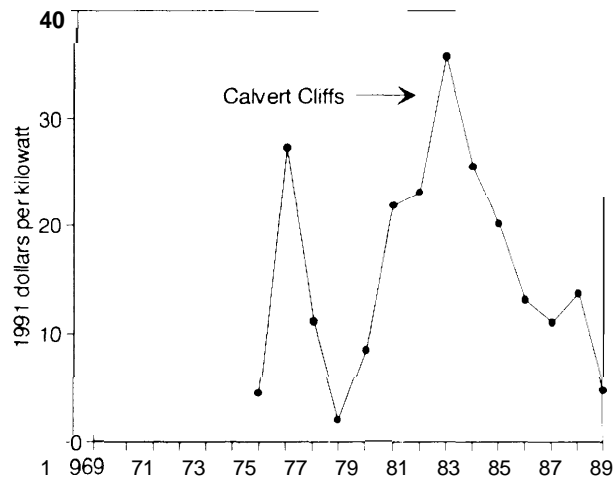
In the late 1980s, performance at Calvert Cliffs degraded significantly. First, BG&E identified several problems with engineering support and system maintenance. Second, the NRC fined the utility \$300,000 in March 1988 for failing to certify the ability of certain electrical equipment to perform in cases of hot, wet, and high radiation conditions that could result from a severe accident. When informed of the violation, BG&E shut down Unit 1 for 2 months to evaluate the problem. (Unit 2 was shut down at the time.) To remedy the problem, BG&E qualified or replaced most of the affected equipment.

**Figure 5-1—Calvert Cliffs Non-Fuel Operation and Maintenance Costs (1991 dollars per kilowatt)**



SOURCE: ABZ, Inc. "Case Studies of Nine Operating Nuclear Power Plants: Life Attainment, License Renewal and Decommissioning," contractor report prepared for the Office of Technology Assessment, February 1993.

**Figure 5-2--Calvert Cliffs Capital Additions (1991 dollars per kilowatt)**



SOURCE: ABZ, Inc. "Case Studies of Nine Operating Nuclear Power Plants: Life Attainment, License Renewal and Decommissioning," contractor report prepared for the Office of Technology Assessment, February 1993.

Table 5-2-Performance Indicators for Calvert Cliffs

|  | 1985  | 1986   | 1987   | 1988   | 1989  | 1990  | 1991  |
|--|-------|--------|--------|--------|-------|-------|-------|
| Total scrams. . . . .                        | 7     | 7      | 8      | 4      | 0     | 0     | 2     |
| Scrams > 15% per 1,000 hours . . . . .       | 0.99  | 0.75   | 0.46   | 0.27   | 0     | 0     | 0.06  |
| Scrams < 15% per 1,000 hours. . . . .        | 0     | 0.13   | 0.13   | 0      | 0     | 0     | 0.13  |
| Safety system actuations . . . . .           | 2     | 1      | 2      | 4      | 2     | 2     | 1     |
| Significant events. . . . .                  | 5     | 2      | 8      | 2      | 2     | 0     | 0     |
| Safety system failures. . . . .              | 7     | 1      | 4      | 0      | 7     | 8     | 5     |
| Forced outage rates (%) . . . . .            | 5.67  | 3.38   | 5.13   | 1.75   | 1.88  | 1.88  | 9.38  |
| Equipment forced out per 1,000hours. . . . . | 1.01  | 0.60   | 0.70   | 0.25   | 0.24  | 0     | 0.54  |
| Critical hours. . . . .                      | 8,017 | 15,348 | 12,554 | 14,249 | 3,573 | 1,925 | 6,687 |

SOURCE: ABZ, Inc., "Case Studies of Nine operating Nuclear Power Plants: Life Attainment, License Renewal and Decommissioning," contractor report prepared for the Office of Technology Assessment, February 1993.

BG&E performance during this period led the NRC to add Calvert Cliffs to its "Problem Plants" list, which increases NRC oversight. In 1989, BG&E was fined an additional \$75,000 for violations involving management oversight and the control of plant activities. In March 1989, Unit 2 was shut down after BG&E discovered cracks in its pressurizer heater sleeves. Subsequent analysis determined intergranular stress corrosion cracking (IGSCC) as the cause. Unit 1 continued operating until its next planned refueling shutdown that May, but subsequent inspections found no evidence of IGSCC in that unit as well. BG&E suspected that the Unit 2 heater sleeves were more susceptible to IGSCC, because they were reamed (enlarged) during manufacturing to ease the installation of heater elements.<sup>3</sup> Replacement power costs during the resulting outage were estimated at \$300,000 per unit per day. In part from uncertainty about the utility's restart schedule, as well as uncertainty over recovery of replacement power costs, BG&E's credit ratings were downgraded.

Due to declining performance in the late 1980s and uncertainty related to the heater sleeve cracking, the NRC issued a confirmatory action letter in 1989 preventing the restart of both units. The utility was required to develop corrective action plans for NRC approval. The units were shutdown for several months, after which time the

NRC approved the BG&E plan. The corrective action stipulated procedural upgrades and increased training. These actions, as well as the increased maintenance that occurred during the shutdown, led to a significant increase in O&M costs.

Of the nearly 100 licensee event reports (LERs) submitted to the NRC by BG&E since 1988, the NRC rated 3 as significant events, down from the average number of significant events reported in prior years. Table 5-3 summarizes the 3 significant events at Calvert Cliffs that occurred between 1989 and 1991. In addition, the problems at Calvert Cliffs in the late 1980s are reflected by poor SALP scores during this period. These scores began improving in late 1989 when the NRC noted a substantial change in management attitude that led to aggressive efforts to improve performance. Complete SALP data for Calvert Cliffs are summarized in table 5-4. Notably, the problems of the late 1980s did not have a clear effect on NRC performance indicators at Calvert Cliffs, with the exception of a decline in critical hours.

BG&E is planning or considering several major capital improvements, including the addition of three diesel generators and steam generator replacements. Revised NRC guidance on station blackout accidents prompted the addition of the diesel generators; estimated costs are \$130

<sup>3</sup> *Nucleonics Week*, vol. 30, No. 36, Sept. 7, 1989.

million. BG&E has no definite plans for steam generator replacement but will monitor the performance and material condition of the existing units. Estimated costs are \$100 million to \$200 million per unit, excluding replacement power charges. A decision on steam generator replacement will probably be deferred until BG&E decides whether to pursue license renewal.

During a recent (June 1992) maintenance outage, BG&E employed 1,100 contractors to supplement the 1,400 permanent staff at Calvert Cliffs. The contractor support is expected to decrease to roughly 400 after the outage. Approximately 50 of these remaining 400 contract staff provide unarmed security to supplement the armed BG&E force. The growth in BG&E's permanent staff from a low of about 200 in the late 1970s to its current number stems from several factors, including increased regulatory requirements and the addition of an onsite engineering organization. BG&E's staffing levels are within the typical range for the industry. Increased contractor support during outages is primarily the result of additional craft labor to perform outage-related work such as turbine overhaul, periodic inspections, and major system modifications.

### ■ Life Attainment and License Renewal

Based on internal economic analyses, BG&E currently regards license renewal as desirable, but a final decision is not expected until 1999. In the meantime, the utility has implemented an integrated program to maintain the material condition of systems, structures, and components (SSCs) through the current and any renewed license terms. The goal of the program is to achieve good performance up to and possibly beyond the current plant lifetime, including any preparations for decommissioning. This life-cycle management program includes several phases:<sup>4</sup>

**Table 5-3—Summary of Significant Events at Calvert Cliffs**

| Unit           | Date     | Description   |
|----------------|----------|---|
| Unit 2 . . . . | 3/01/89  | Failure of throttle trip valve in a turbine-driven auxiliary feed pump, with resulting control room fire.   |
| Unit 2 . . . . | 5/05/89  | Boric acid buildup on pressurizer heaters.  |
| Unit 2 . . . . | 12/20/89 | Licensee discovered nonsafety section of piping in service water system could rupture in an earthquake and thus interrupt the flow of safety-related service water to the auxiliary building and the emergency diesel generators. |

SOURCE: ABZ, Inc., "Case Studies of Nine Operating Nuclear Power Plants: Life Attainment, License Renewal and Decommissioning," contractor report prepared for the Office of Technology Assessment, February 1993.

- System screening to identify components either important to license renewal (ITLR) or important to power production (ITPP).
- Analysis of ITLR and ITPP components to identify life cycle management requirements for continued service.
- Evaluation of the effectiveness of existing programs in addressing life-cycle management issues.
- Implementation of new or modified programs and evaluation of the generic applicability of lessons learned.
- Review of existing plant maintainability and reliability. This phase includes an evaluation of potential major improvements that could lead to significant nuclear safety and personnel benefits.

This integrated program is intended to provide information needed to optimize life-cycle decisions. Program costs are \$5 million per year, and \$1 million is cofunded by the Electric Power Research Institute (EPRI). BG&E has finished reviewing one system (the salt water cooling system) and has begun to review four others: control room and switchgear heating, ventilating,

<sup>4</sup>Baltimore Gas and Electric Co., "Life Cycle Management Program," June 9, 1992.

**Table 5-4-Summary of Calvert Cliffs SALP Scores**

| Assessment period    | Plant operations | Radiological controls | Maintenance/surveillance | Emergency preparedness | Engineering Security | technical support | Safety assessment/quality verification |
|----------------------|------------------|-----------------------|--------------------------|------------------------|----------------------|-------------------|--|
| 1/90-3/9. . . . .    | 2                | 2                     | 2                        | 2                      | 1                    | 2                 | 2                                      |
| 12/88-12/89. . . . . | 3                | 2                     | 3                        | 2                      | 1                    | 2                 | 3                                      |
| 9187-1 1/88. . . . . | 2                | 1                     | 2                        | 2                      | 1                    | 2                 | 3                                      |

| Assessment period    | Plant operations | Radiological controls | Maintenance | Surveillance | Fire protection | Emergency preparedness | Security | Outages | Quality programs and administrative controls effecting quality | Licensing activities | Training and qualification effectiveness |
|----------------------|------------------|-----------------------|-------------|--------------|-----------------|------------------------|----------|---------|--|----------------------|--|
| 5/86-8/87. . . . .   | 2                | 1                     | 2           | 2            | N               | 2                      | 1        | 1       | 2  | 2                    | 2  |
| 10/84-4/86. . . . .  | 2                | 1                     | 2           | 1            | N               | 1                      | 1        | 2       | 2  | 1                    | 2  |
| 10/83-8/84. . . . .  | 1                | 1                     | 2           | 2            | 1               | 1                      | 1        | 1       | N  | 1                    | N  |
| 10182-9/63. . . . .  | 2                | 2                     | 3           | 3            | 1               | 2                      | 1        | 2       | N  | 2                    | N  |
| 10181 -9182. . . . . | 2                | 1                     | 2           | 1            | 1               | 1                      | 2        | 1       | N  | 2                    | N  |
| 10179-9180 . . . . . | 3                | 2                     | 3           | 2            | 2               | 2                      | 3        | 2       | 3  | N                    | N  |

NOTE: Category 1 indicates superior performance, where reduced NRC attention may be appropriate; Category 2 indicates good performance and a recommendation to maintain normal NRC attention; Category 3 indicates acceptable performance, where NRC may consider increased inspections, and Category N indicates insufficient information to support an assessment. As these categories suggest, the NRC SALP rankings include no failing grades.

SOURCE: ABZ, Inc., "Case Studies of Nine Operating Nuclear Power Plants; Life Attainment, License Renewal and Decommissioning," contractor report prepared for the Office of Technology Assessment, February 1993.

and air conditioning (HVAC) systems; compressed air; containment structures; and the reactor coolant system including the reactor vessel. BG&E believes this program has already paid off by redirecting efforts to upgrade the salt water cooling system. Although the utility has not yet decided whether to pursue license renewal, information from the life cycle management program provides the foundation for a license renewal application.

A joint EPRI-BG&E project has addressed concerns about information storage retrieval for the plant. PC-based software was developed to ease the organization, storage, and retrieval of life cycle information. The system, named "LCMDATA" (for "life cycle management data"), will support evaluations of material conditions relevant to age-related degradation. Both text-based and graphical information can be stored and retrieved. The system will document evaluations and provide information to assist a license renewal application should BG&E decide to pursue one. BG&E may expand LCMDATA to track equipment covered by the recent NRC maintenance rule.

BG&E is currently concerned about potential reactor vessel embrittlement during a particular accident sequence at the end of plant life. Specifically, BG&E must demonstrate that embrittlement will not eliminate the margin of protection against Unit 1 vessel failure from a small-break, loss-of-coolant accident at the end of plant life, where vessel pressure remains high while the vessel downcomer is cooled by the safety injection system. Analysis of the Calvert Cliffs vessels indicates that Unit 2 is adequate for more than 60 years, but Unit 1 is projected to require further analysis to operate beyond 2005 (9 years *before* current license expiration). Different fabrication techniques and materials are responsi-

ble for the relative vulnerability of Unit 1 compared to Unit 2. While no decision has been made yet, BG&E is considering several solutions to the Unit 1 problem: demonstration of slower than assumed embrittlement; reduction in the neutron flux experienced by the vessel; modifications to heat the injection water; more thorough analysis to alleviate current concerns; or vessel annealing.

The utility intends to keep license renewal as an option, and in support of this effort, tailored the Integrated Plant Assessment requirement of NRC's License Renewal rule to the plant's service water system.<sup>5</sup> The NRC has informally recognized the life-cycle management program at Calvert Cliffs as an effective tool in the license renewal process. In the meantime, no additional NRC inspections or audits are anticipated beyond those that are standard for the industry. Other than the programs discussed above, there are no other significant research efforts at Calvert Cliffs, except those performed by the industry through groups such as EPRI.

In 1989, BG&E applied for an NRC license to construct an independent spent fuel storage installation (ISFSI) at the Calvert Cliffs site to provide additional temporary spent fuel storage space until the U.S. Department of Energy (DOE) begins accepting the material.<sup>6</sup> ISFSI construction began in April 1991 and completion is scheduled for October 1992. The ISFSI will provide enough additional spent fuel storage space until 2003 at a cost of about \$24 million, which includes \$18 million for capital costs and \$6 million for operations and maintenance. If more space is necessary—which would be the case if the DOE is not accepting spent fuel by 2003—additional space is authorized for operations until 2030.

---

<sup>5</sup> Stone and Webster Engineering Corp., and Baltimore Gas and Electric Co., Service (*Salt*) Water System Life-Cycle Management Evaluation, EPRI TR-102204 (Palo Alto, CA: Electric Power Research Institute, April 1993).

<sup>6</sup> Baltimore Gas and Electric Co., "Calvert Cliffs Nuclear Power Plant Independent Spent Fuel Storage Installation Project, Status Report," June 8, 1992.



Table 5-5-Hope Creek Construction and Licensing History

|                  | Date of construction permit | Construction cost (year of expenditure, In millions) | Operating license start date | Commercial operation | License expiration | Lifetime capacity factor |
|------------------|-----------------------------|--|------------------------------|----------------------|--------------------|--------------------------|
| Unit 1 . . . . . | November 1974               | \$3,506.7  | April 1986                   | December 1986        | April 2026         | 81.9 percent             |

SOURCE: ABZ, Inc., "Case Studies of Nine Operating Nuclear Power Plants: Life Attainment, License Renewal and Decommissioning," contractor report prepared for the Office of Technology Assessment, February 1993.

## ■ Decommissioning

BG&E owns 100-percent, undivided interest in both Calvert Cliffs units. (When there are multiple owners of a nuclear power plant, decommissioning costs are generally divided according to the proportion of ownership.) In a 1990 letter to the NRC, BG&E noted its decision to use qualified external sinking funds to provide financial assurance for decommissioning both units.<sup>7</sup> Decommissioning costs of \$137.3 million (1989 dollars) per unit were calculated using 10 CFR 50.75(c). Annual deposits to the external funds will amount to \$5.5 million for Unit 1 and \$5.1 million for Unit 2. (Each rate is based on the remaining lifetime of the respective unit.) In 1989, the Unit 1 fund was \$414,165 below the required amount, and the Unit 2 fund was \$2.4 million above the required amount. At the end of 1989, the Unit 1 trust fund held \$5.1 million and the Unit 2 fund \$7.5 million.

BG&E has made no formal plans for decommissioning but intends to begin investigating options in 1993. Because both Calvert Cliffs units have substantial time remaining in their operating licenses, BG&E considers decommissioning planning premature at present. No analysis of decommissioning options has been performed yet, and the impact of premature retirement or license renewal of either unit has not been analyzed. The lack of specific action towards these issues for

units of this age is consistent with common industry practice.

## HOPE CREEK CASE STUDY<sup>8</sup>

### ■ Performance and Operating History

Hope Creek is a relatively young 1,031-MWe BWR constructed by Bechtel and operated by the Public Service Electric and Gas Co. (PSE&G) in New Jersey. The single-unit plant is jointly owned by PSE&G (95 percent) and Atlantic City Electric (ACE) Co. (5 percent). The term of the operating license is based on 40 years from the date of approval, thus automatically recovering the construction period. A summary of the construction and licensing history for Hope Creek is listed in table 5-5.

Hope Creek's performance since its recent entry into commercial operation has been above the industry average. NRC reviews of the plant note a conservative, safety-conscious approach; a sound management philosophy; good administrative programs; and skillful personnel—all reflected by both the lack of serious NRC regulatory violations and good SALP ratings (table 5-6). The plant's critical operating time exceeds industry averages and operating costs have equaled or slightly exceed industry averages (figure 5-3). NRC performance measures reveal one problem area with Hope Creek relative to the industry

<sup>7</sup> Baltimore Gas and Electric Co., "Calvert Cliffs Nuclear Power Plant Units 1 and 2, Submittal of Certification of Financial Assurance for Decommissioning," letter dated July 24, 1990.

<sup>8</sup> Unless noted otherwise, all information in the discussion of this unit is from personal communication between the Public Service Electric and Gas Co. (PSE&G; James Bailey et al.), ABZ, Inc. (Edward Abbott and Nick Capik), and the Office of Technology Assessment (Robin Roy and Andrew Moyad) on, and subsequent to, June 1, 1992.

Table 5-6-Summary of Hope Creek SALP Scores

| Assessment period   | Plant operations | Radiological controls | Maintenance surveillance | Emergency preparedness | Engineering security | technical support | Safety assessment/quality verification |
|---------------------|------------------|-----------------------|--------------------------|------------------------|----------------------|-------------------|--|
| 8/90-3/92. . . . .  | 1                | 1                     | 2                        | 1                      | 1                    | 1                 | 1                                      |
| 5/89-7/90. . . . .  | 1                | 1                     | 2                        | 1                      | 1                    | 1                 | 1                                      |
| 1188-4189 . . . . . | 1                | 1                     | 2                        | 2                      | 1                    | 2                 | 2                                      |

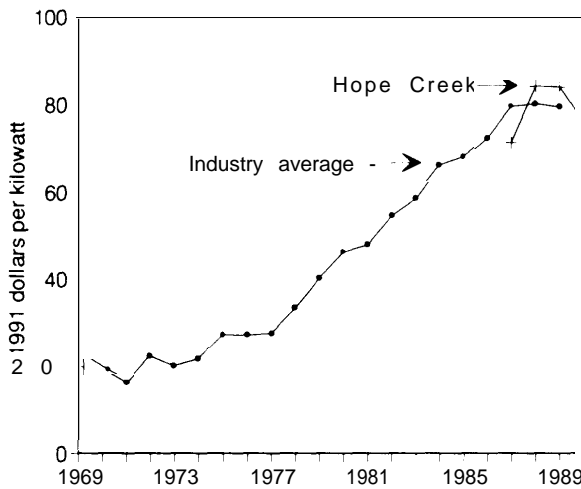
  

| Assessment period     | Plant operations | Radiological controls | Maintenance surveillance | Fire protection | Emergency preparedness | security | Outages | Quality programs and administrative controls effecting quality | Licensing activities | Training and qualification effectiveness |   |
|-----------------------|------------------|-----------------------|--------------------------|-----------------|------------------------|----------|---------|--|----------------------|--|---|
| 1286-1/88. . . . .    | 2                | 2                     | 1                        | 2               | N                      | 1        | 1       | N  | 2                    | 2  | 1 |
| 11/85-1 1/86. . . . . | 2                | 2                     | 1                        | 2               | N                      | 1        | 1       | N  | 2                    | 1  | 2 |

NOTE: Category 1 indicates superior performance, where reduced NRC attention maybe appropriate; Category 2 indicates good performance and a recommendation to maintain normal NRC attention; Category 3 indicates acceptable performance, where NRC may consider increased inspections, and Category N indicates insufficient information to support an assessment. As these categories suggest, the NRC SALP rankings include no failing grades.

SOURCE: ABZ, inc., "Case Studies of Nine Operating Nuclear Power Plants; Life Attainment, License Renewal and Decommissioning," contractor report prepared for the Office of Technology Assessment, February 1983.

**Figure 5-3-Hope Creek Non-Fuel Operation and Maintenance Costs (1991 dollars per kilowatt)**



SOURCE: ABZ, Inc. "Case Studies of Nine Operating Nuclear Power Plants: Life Attainment, License Renewal and Decommissioning," contractor report prepared for the Office of Technology Assessment, February 1993.

(table 5-7). This area, the number of safety system failures, has recently been addressed by a comprehensive review performed by the utility.

Since commercial operation began in 1986, LERs have averaged 44 per year, which is above the industry average, but most occurred in the first 2 years of operation. PSE&G attributes this larger than average number to the reporting philosophy

at Hope Creek, where events are reported that other utilities might not report. Consistent with this explanation, the NRC has classified only one LER in the past 5 years as significant. This single event is summarized in table 5-8.

PSE&G has 2,200 permanent staff working at its three units (Hope Creek and two Salem units), administrative offices, and training center (located nearby). In addition to this staff, contractors are hired for short-term projects, such as outage work. About 500 to 600 contractors are necessary to supplement the permanent staff for each unit outage. With no outage, only 200 to 300 contractors are needed. This permanent contractor group includes security personnel. In the mid-1980s PSE&G evaluated which contractor positions would be more appropriate for permanent staff. However, no data are readily available regarding the number of contractor positions eliminated, the increase in permanent staff positions, or the net effect on costs and performance.

### ■ Life Attainment and License Renewal

Although the Hope Creek plant is relatively new, PSE&G has initiated a Configuration Baseline Documentation Project to monitor the material condition of SSCs during the current and any renewed license terms. Part of the motivation for this long-term effort was a 52-day plant

**Table 5-7—Performance Indicators for Hope Creek**

|   | 1986  | 1987  | 1988  | 1989  | 1990  | 1991  |
|---|-------|-------|-------|-------|-------|-------|
| Total scrams. . . . .                         | 9     | 5     | 4     | 2     | 4     | 2     |
| Scrams > 15% per 1,000 hours. . . . .         | 0.55  | 0.7   | 0.25  | 0.16  | 0.55  | 0.41  |
| Scrams < 15% per 1,000 hours. . . . .         | 1.5   | 0     | 0     | 0     | 0     | 0     |
| Safety system actuations, . . . . .           | 24    | 7     | 6     | 1     | 3     | 3     |
| Significant events. . . . .                   | 2     | 1     | 0     | 0     | 0     | 0     |
| Safety system failures. . . . .               | 5     | 5     | 8     | 3     | 4     | 5     |
| Forced outage rates. . . . .                  | 23    | 9.5   | 4.8   | 1.5   | 6.5   | 6.25  |
| Equipment forced out per 1,000 hours. . . . . | 0.55  | 1.03  | 0.76  | 0.52  | 0.28  | 0.58  |
| Critical hours. . . . .                       | 2,669 | 7,569 | 7,089 | 6,814 | 8,020 | 7,380 |

SOURCE: ABZ, inc., "Case Studies of Nine Operating Nuclear Power Plants: Life Attainment, License Renewal and Decommissioning," contractor report prepared for the Office of Technology Assessment, February 1993. Category N indicates insufficient information to support an assessment. As these categories suggest, the NRC SALP rankings include no failing grades.

shutdown at Salem caused by incomplete design information. Eighty-two systems at Hope Creek are involved in the project, which is scheduled for completion in 1998 at a total cost of \$16 million (excluding any maintenance needs identified during the project). PSE&G claims this project has improved understanding about plant design, improved design control and engineering productivity, and formed a better foundation for evaluating potential design modifications. In addition, PSE&G considers this program part of the foundation for future considerations of license renewal.

No deficiencies have been identified that would preclude Hope Creek license renewal. Other than those in the current revitalization program, no significant capital additions are contemplated. No other activities related to license renewal are planned for the near future, and no significant research efforts are being undertaken. Finally, no additional NRC inspections or audits are anticipated other than those standard for the industry.

The Hope Creek operating license expires in 2026, but the unit's spent fuel pool has sufficient space for operations only until 2010. Although no plans have been made for additional temporary storage space, adequate space is available on the site if new facilities (i.e., dry storage) become necessary.

## ■ Decommissioning

Hope Creek's two joint owners (PSE&G and ACE) will divide the decommissioning costs. In a 1990 decommissioning report submitted to the NRC, PSE&G estimated its share of decommissioning costs at \$165.2 million (1990 dollars).<sup>9</sup> To reach this amount, PSE&G will deposit \$4.6 million annually in a qualified external sinking fund. At the end of 1989, the PSE&G fund

**Table 5-8-Summary of Significant Events at Hope Creek**

| Date              | Description  |
|-------------------|--|
| 10/10/87. . . . . | Scram with safety relief valve stuck open during surveillance testing. |

**SOURCE:** ABZ, Inc., "Case Studies of Nine Operating Nuclear Power Plants: Life Attainment, License Renewal and Decommissioning," contractor report prepared for the Office of Technology Assessment, February 1993.

contained \$13.9 million (1989 dollars). In its 1990 decommissioning report provided to the NRC, ACE estimated its share of the total escalated decommissioning cost at \$8.7 million (1990 dollars), which is deposited into an external sinking fund at the rate of \$226,000 per year.<sup>10</sup> The expected value of the ACE fund at the time of decommissioning is \$13 million.

In addition to decommissioning reports submitted to the NRC, PSE&G has commissioned two site-specific cost estimates for Hope Creek. The frost study was performed by TLG Services, Inc. (TLG) in 1987 and estimated total costs at \$350 million. A 1990 update by TLG increased the estimate to \$450 million (1990 dollars).<sup>11</sup> PSE&G claims that the increase is due to the added costs of on site spent nuclear fuel storage, increased labor rates, the development of more realistic schedules for decommissioning activities, higher low-level waste compaction and disposal charges, higher energy costs, and higher insurance costs. PSE&G estimates the disposal of radioactive waste will amount to 30 percent of the total cost and may be underestimated because of the uncertainty about the availability of disposal sites in the future. These studies have not been submitted to the NRC but are used as a basis for the rate base.

PSE&G has not evaluated the potential impact of early retirement for the Hope Creek facility.

<sup>9</sup> Public Service Electric and Gas Co., "Hope Creek Generating Station Report and Certification of **Financial Assurance** for Decommissioning," July 1990.

<sup>10</sup> Atlantic Electric Co., "Decommissioning Reports Relating to Atlantic Electric Company's Ownership Interests in Hope Creek, Peach Bottom Units 2 and 3, and Salem Units 1 and 2," letter dated July 26, 1990.

<sup>11</sup> At the time of this study, the decommissioning cost update was involved in a rate case and was not available for review.

The 1990 decommissioning studies assume a license period that recovers the construction period. At present, PSE&G has not analyzed the impact of license renewal on decommissioning planning or funding. This is consistent with industry practice.

The New Jersey State legislature is considering legislation that would require the periodic review of estimated decommissioning costs for nuclear generating stations in the State.<sup>12</sup> The intent of the bill is to assure that adequate funds are available for decommissioning at the end of plant operations. The bill includes reporting requirements for decommissioning trust funds to monitor their progress. The bill contains several significant provisions:

New Jersey utilities must file site-specific or site-adjusted decommissioning cost estimates by January 1, 1993, and every 3 years thereafter. Within 10 years of ending commercial operation, the filing interval is reduced to 18 months.

Decommissioning cost estimates must document the current status and developing trends for all activities that could affect decommissioning costs, including the following:

- actual decommissioning cost experience, both foreign and domestic;
- the development and use of state-of-the-art equipment and techniques, such as robotics, chemical cleaning methods, and waste processing methods;
- the development of both high-level and low-level radioactive waste disposal sites and their cost structures;
- transportation methods and hardware;
- applicable regulatory changes; and
- estimates of insurance costs.

Annual reports on decommissioning trust funds must be filed, documenting asset value, portfolio

mix, achieved returns, earnings indices (for benchmarking trust fund performance), and applicable management fees. In addition, the New Jersey Board of Regulatory Commissioners must be notified of any changes in decommissioning trust fired agreements.

This legislation provides for a written comment period after information is submitted by utilities. After such period, the Board would determine whether funding levels require formal review prior to future base rate filings. If so, the Board would initiate proceedings, including a discovery process, rights of intervention, and public and/or evidentiary hearings.

## MONTICELLO CASE STUDY<sup>13</sup>

### ■ Performance and Operating History

Monticello is a 545-MWe General Electric BWR constructed by Bechtel and owned and operated by the Northern States Power (NSP) Co. The single-unit plant entered commercial operation in January 1971, and the current license expires in September 2010. The 2010 date includes the recovery of the construction period, which extended the license 3 years. This extension was requested in February 1987 and granted by the NRC in November the same year. A summary of the construction and licensing history for Monticello is listed in table 5-9.

Monticello reliability, as measured by length of critical operations, has consistently surpassed the industry average. Other performance indicators reveal no weaknesses or other noteworthy trends. Instead, these indicators and the periodic SALP reviews suggest consistent plant reliability, strong regulatory performance, and stable operations (table 5-10). There have been few significant events at Monticello; the NRC has recorded

<sup>12</sup> New Jersey Board of Regulatory commissioners, "Nuclear Generating Plant Decommissioning Proposed New Rules," letter dated Mar. 6, 1992.

<sup>13</sup> Unless noted otherwise, all information in the discussion of this unit is from personal communication between Northern States Power Co. (NSP; Terry Pickens et al.), ABZ, Inc. (Edward Abbott), and the Office of Technology Assessment (Robin Roy) on, and subsequent to, Oct. 27, 1992.

**Table 5-9—Monticello Construction and Licensing History**

| Date of construction permit | Construct ion cost (year of expenditure, In millions) | Operating license start date | Commercial operation | License expiration | Lifetime capacity factor |
|-----------------------------|---|------------------------------|----------------------|--------------------|--------------------------|
| Unit 1. . . . . June 1967   | \$119.1   | January 1971                 | June 1971            | September 2010     | 71.2 percent             |

SOURCE: ABZ, Inc., "Case Studies of Nine Operating Nuclear Power Plants: Life Attainment, License Renewal and Decommissioning," contractor report prepared for the Office of Technology Assessment, February 1993.

only two in the last 5 years. These significant events are summarized in table 5-11. A summary of SALP scores for Monticello is listed in table 5-12.

Monticello O&M costs have been consistently above the industry average with year-to-year variations reflecting the added costs of refueling outages (figure 5-4). In contrast, plant capital additions have remained generally at or below industry averages (figure 5-5). In 1983, NSP replaced the stainless steel piping in the recirculation system and several connected branch systems at Monticello. This piping is used for reactivity control (i.e., control of reactor power during operation) and was replaced due to its vulnerability to IGSCC. Consequently, there was a large, one-time increase in capital additions.

NSP employs a staff of about 400 for all of Monticello activities, including corporate support and onsite personnel. Onsite staff numbers about 350: about 300 permanent employees and 50 contractors. To help control O&M costs, NSP has performed recent reorganizations to reduce the

number of contractors and streamline the overall organization.

**■ Life Attainment and License Renewal**

Monticello was the second U.S. nuclear power plant to initiate an application for NRC license renewal as part of the lead-plant effort. NSP began the process in September 1988 and anticipated preparatory costs of about \$40 million over 6 or 7 years. This estimate included company costs, NRC fees, contractor costs, legal expenses, and public relations and communications costs. Since 1988, NSP has spent about \$9 million of its own funds and about \$4.5 million of DOE and EPRI monies; thus, most of the funds budgeted for the license renewal application remain. In 1992, NSP announced an indefinite deferral of the filing of a license renewal application largely due to uncertainties interpreting the NRC license renewal rule and State concerns over spent fuel disposal. For example, NSP noted its concern that the number of reactor systems to be examined f o r

**Table 5-10-Performance Indicators for Monticello**

|   | 1985  | 1986  | 1987  | 1988  | 1989  | 1990  | 1991  |
|---|-------|-------|-------|-------|-------|-------|-------|
| Total scrams. . . . .                         | 3     | 2     | 4     | 1     | 2     | 1     | 4     |
| Scrams > 15% per 1,000 hours. . . . .         | 0.48  | 0.23  | 0.48  | 0.11  | 0.32  | 0.12  | 0.47  |
| Scrams <15% per 1,000 hours. . . . .          | 0     | 0     | 0     | 0     | 0     | 0     | 0.5   |
| Safety system actuations. . . . .             | 0     | 2     | 1     | 0     | 1     | 0     | 3     |
| Significant events. . . . .                   | 0     | 3     | 1     | 0     | 0     | 1     | 1     |
| Safety system failures. . . . .               | 0     | 4     | 3     | 0     | 6     | 2     | 6     |
| Forced outage rates. , . . . . .              | 0.67  | 0.75  | 1.5   | 0.25  | 1.75  | 2.5   | 4.25  |
| Equipment forced out per 1,000 hours. . . . . | 0.15  | 0.12  | 0.37  | 0.12  | 0     | 0     | 0.12  |
| Critical hours. , . . . . .                   | 6,427 | 6,984 | 7,174 | 8,769 | 6,679 | 8,487 | 7,076 |

SOURCE: ABZ, Inc., "Case Studies of Nine Operating Nuclear Power Plants: Life Attainment, License Renewal and Decommissioning," contractor report prepared for the Office of Technology Assessment, February 1993.

**Table 5-n-Summary of Significant Events  
at Monticello**

| Date               | Description   |
|--------------------|---|
| 9/1 1/90 . . . . . | Both emergency diesel generators were vulnerable to the potential failure of a non-seismic fire suppression pipe.   |
| 8/23191 . . . . .  | The original analysis of internal flooding neglected to amount for the potential loss of the diesels and redundant trains of electric equipment. No other performance indicators were involved. |

SOURCE: ABZ, Inc., "Case Studies of Nine Operating Nuclear Power Plants: Life Attainment, License Renewal and Decommissioning," contractor report prepared for the Office of Technology Assessment, February 1993.

license renewal remained Unspecified, but had increased from 74 to at least 104.

Two technical issues have arisen in the Monticello license renewal process that have led to uncertainty over the practical interpretation of the license renewal rule. First, in accordance with 10 CFR 50.49, plant electrical equipment must be qualified to withstand the effects of an accident. Monticello currently complies with the rule by adhering to an Institute of Electrical and Electronics Engineers (IEEE) standard published in 1971. This standard, along with other documents, comprises the Monticello equipment qualification (EQ) program. The EQ program requires that, when replacing any electrical equipment, NSP must use equipment that is qualified based on a subsequent 1974 standard with stricter requirements. This process of gradual replacements and upgrades has been reviewed by the NRC, found acceptable, and become part of Monticello's current licensing basis. However, based on discussions with NRC staff, Monticello believes it may be required to upgrade to the 1974 standard as a condition for license renewal. NSP estimates that it would cost about \$40 million, much of which would be spent analyzing plant cabling. NSP believes that most cabling would be found acceptable based on similar analysis done by Sandia Laboratories.

The second technical issue involves a potential upgrade to a piping code that requires considera-

tion of the conditions ("environment") created by the fluid within the pipe. Monticello piping was qualified to an older American Society of Mechanical Engineers (ASME) code when the plant was constructed (ASME B31.1), whereas plants built today must comply with another code (ASME Section III). ASME is considering the inclusion of "environmental factors" in an upcoming revision of the code. As a result, NSP believes that the NRC staff will require such environmental factors to be included in their analysis of the adequacy of Monticello piping. NSP, based on discussions with one member of the code committee, believes that although not explicit in ASME B31.1, the code does implicitly account for environmental factors. In addition, NSP contends that its own inservice inspection program would detect pipe cracking due to environmental factors before pipe failure. Given this inspection program and what it believes to be the adequacy of the current piping requirements, NSP believes upgrading to a yet unapproved standard to renew the license is not needed.

In both cases, the current licensing bases for Monticello are intended to provide an adequate level of safety for continued operation for the time remaining in the operating license. As such, NSP believes the license renewal rule does not require upgrading to new standards. The NRC staff, however, believes such upgrades can be imposed under the "regulatory oversight" portion of the rule. NRC clarification is needed to resolve these technical issues. In the interim, the Monticello license renewal application has been indefinitely deferred.

Before Monticello's license can be extended, the spent fuel pool at the plant will require additional capacity. Without more fuel storage capacity operations will need to cease by 2005. (Currently, Monticello operates on 18 month fuel cycles.) NSP already expanded spent fuel storage capacity in 1978 with the addition of high-density fuel racks. The utility may extend the fuel cycle to 24 months and thereby extend the capacity of the fuel pool to 2010.

**Table 5-12-Summary of Monticello SALP Scores**

| Assessment period     | Plant operations | Radiological controls | Maintenance/surveillance | Emergency preparedness | Engineering Security | technical support | Safety assessment/quality verification |
|-----------------------|------------------|-----------------------|--------------------------|------------------------|----------------------|-------------------|--|
| 3/89-6/90. . . . .    | 1                | 2                     | 1                        | 1                      | 2                    | 2                 | 1                                      |
| 12187-2189, . . . . . | 1                | 1                     | 1                        | 1                      | 3                    | 2                 | 2                                      |

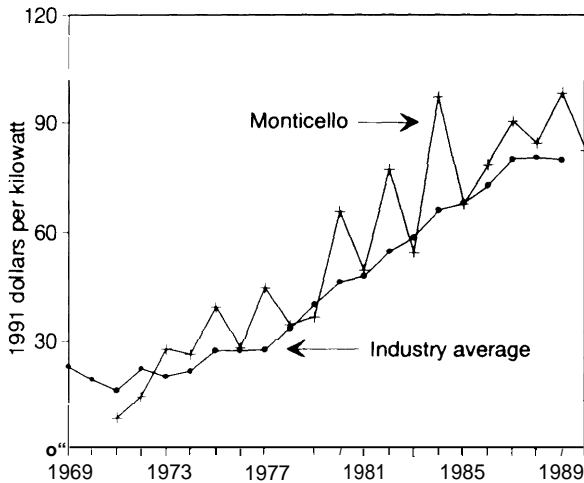
| Assessment period    | Plant operations | Radiological controls | Maintenance | Surveillance | Fire protection | Emergency preparedness | Security | Outages | Quality programs and administrative controls effecting quality | Licensing activities | Training and qualification effectiveness |
|----------------------|------------------|-----------------------|-------------|--------------|-----------------|------------------------|----------|---------|--|----------------------|--|
| 6/86-1 1187. . . . . | 2                | 1                     | 1           | 1            | 1               | 1                      | 2        | 1       | 2  | 1                    | 2  |
| 12184- 5186. . . . . | 1                | 1                     | 1           | 2            | 1               | 1                      | 1        | 1       | 2  | 1                    | 2  |
| 7/83-11/84. . . . .  | 1                | 2                     | 1           | 2            | 2               | 1                      | 1        | 1       | 2  | 1                    | N  |
| 7/82-6-83. . . . .   | 2                | 2                     | 2           | 1            | 2               | 1                      | 1        | 1       | N  | 2                    | N  |
| 7/81-6183. . . . .   | 1                | 2                     | 2           | 1            | 2               | 1                      | 1        | 1       | N  | 1                    | N  |
| 7/80-6181. . . . .   | 1                | 2                     | 1           | 1            | 2               | 2                      | 2        | 1       | N  | N                    | N  |
| 10/79-9/80. . . . .  | 2                | 3                     | 2           | 2            | 2               | 3                      | 2        | 2       | 2  | N                    | 2  |

NOTE: Category 1 indicates superior performance, where reduced NRC attention maybe appropriate; Category 2 indicates good performance and a recommendation to maintain normal NRC attention; Category 3 indicates acceptable performance, where NRC may consider increased inspections, and Category N indicates insufficient information to support an assessment. As these categories suggest, the NRC SALP rankings include no failing grades.

SOURCE: ABZ, Inc., "Case Studies of Nine Operating Nuclear Power Plants; Life Attainment, License Renewal and Decommissioning," contractor report prepared for the Office of Technology Assessment, February 1993.

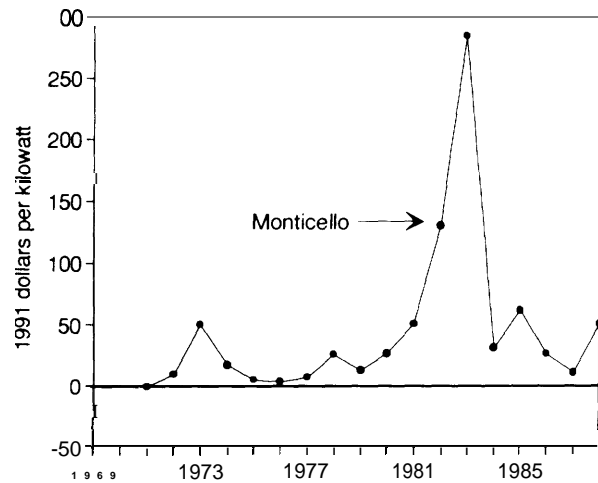


**Figure 5-4--Monticello Non-Fuel Operation and Maintenance Costs (1991 dollars per kilowatt)**



SOURCE: ABZ, Inc. "Case studies of Nine Operating Nuclear Power Plants: Life Attainment, License Renewal and Decommissioning," contractor report prepared for the Office of Technology Assessment, February 1993.

**Figure H-Monticello Capital Additions (1991 dollars per kilowatt)**



SOURCE: ABZ, Inc. "Case Studies of Nine Operating Nuclear Power Plants: Life Attainment, License Renewal and Decommissioning," contractor report prepared for the Office of Technology Assessment, February 1993.

To renew Monticello’s license, NSP will have to build a dry cask storage facility. However, the State of Minnesota requires a “certificate of need” before storage of spent fuel at the plant site can be increased. NSP requested and received a certificate of need to install the high-density spent fuel storage racks in 1978 but has not yet requested certification for the dry cask storage facility. This application will be a milestone in the license renewal process.

### ■ Decommissioning

NSP owns a 100 percent, undivided interest in Monticello. In a 1990 decommissioning report submitted to the NRC, NSP indicated a Monticello decommissioning trust fired target value of \$119 million (1986 dollars).<sup>14</sup> Initial annual deposits into an external trust fund were projected at \$11.4 million. In subsequent correspondence,

NSP stated that the Minnesota Public Utilities Commission denied their request for a rate increase to collect these monies. Later, in 1991, the utility was permitted to start recovering the estimated decommissioning costs.

To evaluate decommissioning costs in more detail, NSP commissioned TLG Engineering, Inc. (TLG) to develop a site-specific estimate. Only the DECON alternative was evaluated. This study estimated decommissioning costs of \$277.4 million (1990 dollars). The current collections for decommissioning total \$30 million: \$9.7 million in internal funds, \$17 million in an external, tax-qualified fund, and \$3.6 million in an external, nonqualified fund. There has been no evaluation of the potential impact on decommissioning of premature retirement or license renewal at Monticello.

<sup>14</sup>Northern States Power CO., “Monticello Nuclear Generating Plant Amendment to Financial Assurance for Decommissioning,” letter dated Sept. 6, 1990.

Table 5-13-Salem Construction and Licensing History

|                 | Date of construction permit | Construction cost (year of expenditure, In millions) | Operating license start date | Commercial operation | License expiration | Lifetime Capacity factor |
|-----------------|-----------------------------|--|------------------------------|----------------------|--------------------|--------------------------|
| Unit 1. . . . . | September 1968              | \$661.6  | December 1976                | June 1977            | August 2016        | 58 percent               |
| Unit 2. . . . . | September 1968              | \$614.3  | May 1981                     | October 1981         | April 2020         | 59 percent               |

SOURCE: ABZ, Inc., "Case Studies of Nine Operating Nuclear Power Plants: Life Attainment, License Renewal and Decommissioning," contractor report prepared for the Office of Technology Assessment, February 1993.

**SALEM CASE STUDY<sup>15</sup>**

**■ Performance and Operating History**

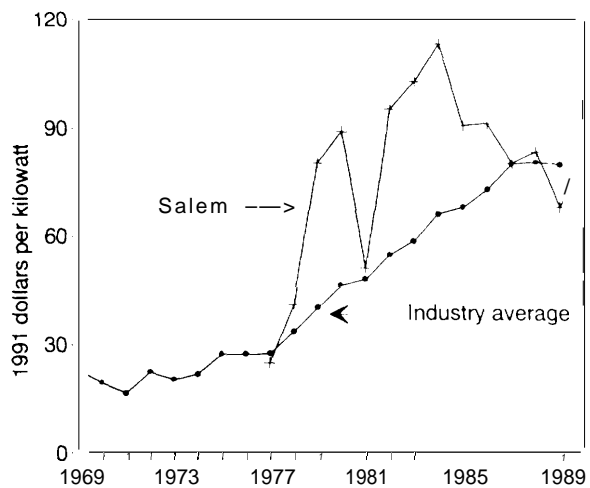
The two units at Salem have four owners: Public Service Electric and Gas Co. (PSE&G), Philadelphia Electric (PE), Atlantic City Electric (ACE), and Delmarva Power and Light (DP&L).<sup>16</sup> Both units are 1,106-MWe Westinghouse PWRs and operated by PSE&G. The license terms for both units reflect recovery of the time spent during construction. The application for this extension was made to the NRC in August 1987 and was approved in June 1991, resulting in the recovery of almost 20 reactor-years of operating time (total for both units). A summary of the construction and licensing history for Salem is listed in table 5-13.

In the early 1980s, Salem experienced several operational difficulties that caused higher than average operating costs (figure 5-6). Capital additions costs have been average, though costs were higher in the early 1980s, partly in response to TMI-mandated backfits (figure 5-7). As indicated by critical operating time, Salem availability has been highly variable, but on average similar to the rest of the industry. Other NRC performance indicators are summarized in table 5-14.

In 1983, a steam generator level transient at Salem resulted in reactor shutdown. An analysis

of the sequence of events (leading up to and following the rapid insertion of the reactor control rods into the core) revealed that critical breakers in the automatic shutdown circuits had failed to operate. If the operators had not manually activated the circuit breakers, the event could have caused significant plant damage. PSE&G was

Figure 5-6--Salem Non-Fuel Operation and Maintenance Costs (1991 dollars per kilowatt)

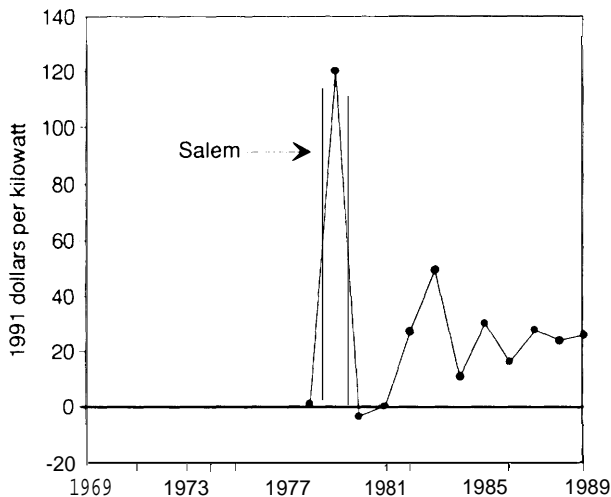


SOURCE: ABZ, Inc. "Case Studies of Nine Operating Nuclear Power Plants: Life Attainment, License Renewal and Decommissioning," contractor report prepared for the Office of Technology Assessment, February 1993.

<sup>15</sup>Unless noted otherwise, all information in the discussion of this plant is from personal communication between Public Service Electric and Gas Co. (PSE&G; James Bailey et al.), ABZ, Inc. (Edward Abbott and Nick Capik), and the Office of Technology Assessment (Robin Roy and Andrew Moyad) on, and subsequent to, June 1, 1992.

<sup>16</sup>PSE&G and PE each own 42.59 percent, and ACE and DP&L each own 7.41 percent.

**Figure 5-7—Salem Capital Additions  
(1991 dollars per kilowatt)**



SOURCE: ABZ, Inc. "Case Studies of Nine Operating Nuclear Power Plants: Life Attainment, License Renewal and Decommissioning," contractor report prepared for the Office of Technology Assessment, February 1993.

freed a then-record \$850,000.<sup>17</sup> The NRC also conducted a full scale investigation of the event, which included almost every aspect of PSE&G's management at Salem. The NRC review led to several significant and costly actions that resulted in above average O&M costs at Salem. Once the actions were completed, O&M costs decreased to levels consistent with the rest of the industry.

The class of event that resulted in the failure of the automatic shutdown system is called an "anticipated transient without scram" (ATWS). In the decade prior to the Salem event, the NRC had been developing a specific ATWS rule to address the potential consequences of such an event. During that time, BWRs were considered to be more susceptible to ATWS than PWRs, and the NRC had required BWR owners to install hardware modifications to make the event less likely and more manageable. After the Salem

ATWS occurred, however, the NRC began to require hardware upgrades, as well as reanalysis of the likelihood of such events at PWRs.

In the late 1980s, the NRC noted several problems at Salem, including periods of inadequate supervision, deficiencies in maintenance and surveillance, and high numbers of personnel errors. Over the past 10 years, Salem has submitted 995 LERs, averaging 46 per year at Unit 1 and 53 per year at Unit 2. This rate is 30 percent higher than the industry average. PSE&G claims that this larger than average number is due to the reporting philosophy at Salem, where events are reported that may not be at other facilities. In the last 5 years, the NRC judged three LERs as significant. These three are summarized in table 5-15. Salem received two additional NRC fines: a \$50,000 fine in March 1988 for fire protection violations and a \$50,000 fine in April 1989 for violations involving environmental qualification of electrical equipment.

In November 1991, the main turbine and generator at Unit 2 sustained severe damage when the turbine failed to trip during testing.<sup>18</sup> An NRC investigation stated the accident was 'preventable.' More than a year before the failure, PSE&G found similar equipment for the Unit 1 turbine inoperative due to mechanical binding. Although PSE&G stated that the matching equipment in Unit 2 would be replaced during its next outage, no replacement was made. Subsequent investigation identified that the Unit 2 equipment was immobilized by foreign debris, rust, and corrosion. Including the costs of replacement power, repairs cost approximately \$76 million. The root cause of this failure was identified as the lack of preventive maintenance, surveillance testing, and procedural compliance.<sup>19</sup>

A summary of SALP scores for Salem is provided in table 5-16. While these scores reflect the problems of 1983 and 1989, they do not

<sup>17</sup> *Nucleonics Week*, vol. 33, No. 31, July 30, 1992.

<sup>18</sup> *Nucleonics Week*, vol. 33, No. 31, July 30, 1992.

<sup>19</sup> *Inside NRC*, vol. 13, No. 22, Nov. 4, 1991.

Table 5-14—Performance Indicators for Salem

|  | 1985   | 1986   | 1987   | 1988   | 1989   | 1990   | 1991   |
|--|--------|--------|--------|--------|--------|--------|--------|
| Total scrams.....                          | 10     | 18     | 5      | 9      | 6      | 5      | 2      |
| Scrams > 15% per 1,000 hours. . . . .      | 0.86   | 1.41   | 0.27   | 0.89   | 0.84   | 1.39   | 0.22   |
| Scrams < 15% per 1,000 hours. . . . .      | 0.13   | 0.5    | 0.13   | 0      | 0.13   | 0      | 0      |
| Safety system actuations. . . . .          | 2      | 3      | 0      | 1      | 4      | 5      | 2      |
| Significant events. . . . .                | 1      | 6      | 3      | 1      | 1      | 0      | 1      |
| Safety system failures. . . . .            | 0      | 6      | 13     | 8      | 5      | 8      | 9      |
| Forced outage rates. . . . .               | 15.83  | 15.25  | 4.623  | 12.5   | 16.5   | 24.5   | 9.25   |
| Equipment forced out per 1,000 hours, 1.44 | 2.19   | 2.19   | 0.50   | 2.01   | 1.73   | 2.78   | 0.41   |
| Critical hours, . . . . .                  | 11,450 | 12,726 | 12,836 | 12,930 | 13,926 | 11,405 | 13,897 |

SOURCE: ABZ, Inc., "Case Studies of Nine Operating Nuclear Power Plants: Life Attainment, License Renewal and Decommissioning," contractor report prepared for the Office of Technology Assessment, February 1993.

appear to anticipate the 1991 turbine accident. In fact, the category for operations actually improved in 1990.

*Staffing.* See Hope Creek, above.

### ■ Life Attainment and License Renewal

PSE&G has initiated several programs to monitor and improve the material condition of SSCs during the current and any renewed license terms:

- *Revitalization:* This 5-year program is aimed at upgrading systems and components to increase their productivity and reliability and to reduce long-term costs. No budget has been established, and the net impact on cost and performance is yet to be determined.
- *Configuration Baseline Documentation Project:* Part of the motivation behind this project was a 52 day plant shutdown at Salem that resulted from incomplete design information. The program covers 54 Salem systems and completion is scheduled in 1996 at a total cost of \$14 million (not including any ensuing expenses). PSE&G maintains that this program has improved their understanding of plant design, improved design control and engineering productivity, and provided a better foundation for evaluating design modifications. In addition, PSE&G considers this program a sound foundation for any future considerations of license renewal.

- *Five-Year Life-Cycle Management Program:* Initiated in 1991, this program consists of system reviews to identify age-related degradation of SSCs. In 1992, four systems were reviewed.

PSE&G has identified no significant issues that would preclude license renewal for the Salem units, although the utility has not performed a full assessment of the NRC requirements. At present, no additional NRC inspections or audits are

Table 5-15-Summary of Significant Events at Salem

| Unit   | Date     | Description  |
|--------|----------|--|
| Unit 1 | 12/09/87 | Procedural and testing inadequacies in the reactor protection and control systems.   |
| Unit 1 | 5/12/89  | Loss of RHR due to inadvertent discharge of the nitrogen accumulator.  |
| Unit 2 | 1/1/91   | Severe damage due to a turbine overspeed, which occurred from the failure of the emergency trip <b>and overspeed protection solenoid valves (SOVs). The SOVs failed due to mechanical binding caused by foreign material, sludge, rust, and corrosion.</b> |

SOURCE: ABZ, Inc., "Case Studies of Nine Operating Nuclear Power Plants: Life Attainment, License Renewal and Decommissioning," contractor report prepared for the Office of Technology Assessment, February 1993.

**Table 5-16-Summary of Salem SALP scores**

| Assessment period    | Plant operations | Radiological controls | Maintenance/surveillance | Emergency preparedness | Engineering Security | technical support | Safety assessment/quality verification |
|----------------------|------------------|-----------------------|--------------------------|------------------------|----------------------|-------------------|--|
| 8/90-12/91 . . . . . | 2                | 2                     | 2                        | 1                      | 1                    | 2                 | 2                                      |
| 5/89-7/90. . . . .   | 2                | 2                     | 2                        | 1                      | 1                    | 2                 | 2                                      |
| 1/88-4/89. . . . .   | 3                | 2                     | 2                        | 2                      | 1                    | 2                 | 2                                      |

| Assessment period    | Plant operations | Radiological controls | Maintenance | Surveillance | Fire protection | Emergency preparedness | Security | Outages | Quality programs and administrative controls effecting quality | Licensing activities | Training and qualification effectiveness |
|----------------------|------------------|-----------------------|-------------|--------------|-----------------|------------------------|----------|---------|--|----------------------|--|
| 10/86-12/87. . . . . | 2                | 2                     | 1           | 2            | N               | 1                      | 1        | 1       | 1  | 2                    | 2  |
| 10/85-9/86. . . . .  | 2                | 1                     | 1           | 2            | N               | 1                      | 1        | 2       | 2  | 2                    | 2  |
| 9/84-9/85. . . . .   | 2                | 1                     | 2           | 2            | 2               | 2                      | 1        | 2       | N  | 2                    | N  |
| 10/83-8/84. . . . .  | 3                | 2                     | 2           | 2            | 3               | 2                      | 1        | 2       | N  | 2                    | N  |
| 10/82-9/83. . . . .  | 3                | 2                     | 2           | 2            | 2               | 1                      | 2        | 1       | N  | 2                    | N  |
| 9/81 -8/82. . . . .  | 2                | 1                     | 1           | 1            | 2               | 2                      | 3        | 1       | N  | 2                    | N  |
| 7/80-6/81. . . . .   | 1                | 2                     | 1           | 1            | 2               | 2                      | 3        | 1       | 1  | N                    | N  |

NOTE: Category 1 indicates superior performance, where reduced NRC attention may be appropriate; Category 2 indicates good performance and a recommendation to maintain normal NRC attention; Category 3 indicates acceptable performance, where NRC may consider increased inspections, and Category N indicates insufficient information to support an assessment, As these categories suggest, the NRC SALP rankings include no failing grades.

SOURCE: ABZ, Inc., "Case Studies of Nine Operating Nuclear Power Plants; Life Attainment, License Renewal and Decommissioning," contractor report prepared for the Office of Technology Assessment, February 1993.

anticipated other than those standard for the industry.

### ■ Spent Fuel Storage

The Salem operating licenses expire August 2016 (Unit 1) and April 2021 (Unit 2). The Unit 1 spent fuel pool has sufficient temporary storage space until 1998, assuming no loss in operational full core reserve (a requirement imposed by the NRC for continued operation). Unit 2 has adequate space until 2002, also assuming no loss in operational full core reserve. Although no plans have been made for additional temporary storage space, adequate space is available on the site if new facilities (i.e., dry storage) become necessary. PSE&G has developed plans to rerack both spent fuel pools, which would permit continued operation (with full core reserve) until 2007 for Unit 1 and 2011 for Unit 2.

### ■ Decommissioning

Salem's four joint owners will divide decommissioning costs. In a decommissioning report submitted to the NRC on July 24, 1990, PSE&G estimated its share of the total estimated decommissioning cost at \$60.5 million (1990 dollars) per unit. PSE&G deposited this amount in a qualified external sinking fund at the rate of \$2.3 million per year for Unit 1 and \$2.0 million per year for Unit 2. Under applicable ratemaking orders, decommissioning cost recovery is based on a net negative salvage value of 20 percent. This additional amount is included in PSE&G's rate base and will be added to the trust fund annually; these funds will be treated as a prepayment for future years. In 1989, trust fund balances were \$20.2 million (Unit 1) and \$14.8 million (Unit 2). Current fund requirements are based on a 1986 TLG study.

In a decommissioning report provided to the NRC on July 26, 1990, PE established its share of the total escalated decommissioning cost at \$60.5 million (1990 dollars) per unit, which will be deposited into either a decommissioning escrow

account or a qualified external sinking fund at the rate of \$2.3 million per year for Unit 1 and \$2.0 million per year for Unit 2. PE anticipates that most future payments will accrue in the trust funds, while payments to the escrow accounts would occur only to prevent the total contribution from exceeding the amount permitted by the Internal Revenue Code to retain tax qualification. As of May 1990, the Unit 1 escrow account had a balance of \$4 million, and the trust fund had a balance of \$7 million. The Unit 2 escrow account had a balance of \$2.7 million, and the trust fund had a balance of \$6.14 million. PE estimates the value of each trust fund will be \$61 million per unit when decommissioning begins.

In a decommissioning report provided to the NRC on July 26, 1990, ACE established its share of the total escalated decommissioning cost at \$10.5 million (1990 dollars) per unit. Deposits will accrue in an external sinking fund at the annual rate of \$628,235 for Unit 1 and \$721,307 for Unit 2. ACE estimates the value of this fund will be \$32 million for Unit 1 and \$38 million for Unit 2 when decommissioning begins. Estimates of fund growth assume a 2 percent return after taxes and inflation. The ACE funding requirements are based on the 1986 TLG study. Finally, the PSE&G decommissioning report indicates the DP&L funding share is \$10.5 million per unit. Annual DP&L deposits into an external sinking fund are \$400,000 for Unit 1 and \$600,000 for unit 2.

In addition to these decommissioning reports submitted to the NRC, PSE&G commissioned site-specific cost estimates for Salem. The first study was performed by TLG in 1987 and estimated decommissioning costs of approximately \$376 million for both units, greatly exceeding the estimates submitted to the NRC. A 1990 update increased the estimates to \$450 million for both units. PSE&G maintains that the increase is due to the increased cost of onsite spent fuel storage, increased labor rates, development of more realistic schedules for decommissioning activities, higher charges for low-level

**waste** compaction and disposal, higher energy costs, and higher insurance liability costs. PSE&G estimates also that disposal of radioactive waste will account for 30 percent of the total cost, which may be an underestimate because of uncertainties associated with the availability and costs of future disposal sites. The TLG studies have not been submitted to the NRC but are used for State utility rate proceedings.

PSE&G appears to have conducted no formal evaluation of the impact on decommissioning in case of the premature retirement of either Salem unit. Consistent with license renewal progress, PSE&G has not modified their decommissioning planning or funding to assess the potential of license renewal. Both of these actions are consistent with common industry practice. Finally, as mentioned in the Hope Creek discussion, legislation currently under review in the New Jersey State legislature may affect future decommissioning planning for Salem.

## SONGS CASE STUDY<sup>20</sup>

### ■ Performance and Operating History

San Onofre is the site of three nuclear power plants operated by Southern California Edison (SCE). The San Onofre Nuclear Generating Station Unit 1 (SONGS 1) began operation in 1968 as a demonstration project cofunded by the Atomic Energy Commission. The unit is a three-loop Westinghouse PWR rated at 436 MWe, although it has operated at less than 380 MWe in recent years due to steam generator problems. SONGS 1 is jointly owned by SCE (80 percent) and San Diego Gas and Electric Co. (SDG&E, 20 percent). SONGS 1 was constructed for \$88 million. Since then, modifications totaling \$720 million have been made, including seismic qualifications, TMI modifications, fire protection, standby power addition, environmental qualifica-

tion, a sphere enclosure project, single-failure analysis, security, and the systematic evaluation program.

SONGS Unit 2 is a 1,070-MWe Combustion Engineering PWR built by Bechtel; commercial operation began in August 1983. SONGS Unit 3 is a 1,080-MWe Combustion Engineering PWR built by Bechtel; commercial operation began in April 1984. These two units are owned jointly by SCE (75.05 percent), SDG&E (20 percent), Anaheim Electrical Division (3.16 percent), and Riverside Public Utilities (1.79 percent). There have been no applications yet to recover license time spent during construction of either Unit 2 or Unit 3. A summary of the construction and licensing history of SONGS is listed in table 5-17.

SONGS 1 has experienced prolonged periods of nonoperation, primarily to fix and replace equipment and to modify the facility to comply with Federal regulations. Since the unit began operation, the steam generators have been a particular problem. Each generator consists of approximately 11,000 tubes used to convert water to steam. Of these tubes, over 1,400 (more than 10 percent) have been plugged due to damage and leakage. Such plugging reduces steam generator performance and thus the amount of electricity generated. These problems prompted SCE in 1980 to insert sleeves into more than 6,900 tubes. The sleeves extend tube life and reduce subsequent degradation. No other nuclear plant in the United States has undertaken such a large-scale sleeving program.

In accordance with the Full-Term Operating License (FTOL), which was formally issued in 1991 for SONGS 1, SCE was required to complete several plant modifications prior to Fuel Cycle 12, as directed by a 1990 NRC order. (Before 1991, SONGS 1 had operated on a provisional operating license.) The changes were estimated to cost about \$125 million and were

<sup>20</sup> Unless noted otherwise, all information in the discussion of this plant is taken from personal communication between Southern California Edison Co. (SCE; Harold Ray, Joseph **Wambold** et al.), ABZ, Inc. (Edward Abbott and Nick **Capik**), and the Office of Technology Assessment (Robin Roy and Andrew **Moyad**) on, and subsequent to, Oct. 14, 1992.

Table 5-17—SONGS Construction and Licensing History

|                  | Date of construction permit | Construction cost (year of expenditure, in millions) | Operating license start date | Commercial operation | License expiration | Lifetime capacity factor |
|------------------|-----------------------------|--|------------------------------|----------------------|--------------------|--------------------------|
| Unit 1 . . . . . | March 1964                  | \$88.0   | March 1967                   | January 1968         | March 2004         | 53.8 percent             |
| Unit 2 . . . . . | October 1973                | \$2,540  | August 1982                  | August 1983          | October 2013       | 72.3 percent             |
| Unit 3 . . . . . | October 1973                | \$2,250  | September 1983               | April 1984           | October 2013       | 76.5 percent             |

SOURCE: ABZ, Inc., "Case Studies of Nine Operating Nuclear Power Plants: Life Attainment, License Renewal and Decommissioning," contractor report prepared for the Office of Technology Assessment, February 1993.

initiated as required. In parallel, SCE sought CPUC approval for the required expenditures, which the utility determined were cost effective. However, the CPUC Division of Ratepayer Advocates (DRA) opposed approval based on its own economic analyses, which found the plant not to be cost effective. There were several areas of disagreement between DRA and SCE involving such issues as future plant capacity factors, future operating costs, potential steam generator replacements, and SCE forecasts of replacement power costs.<sup>21</sup>

In 1992, SCE, SDG&E, and the CPUC agreed to close the 23-year-old plant, because of the potential problems with cost effectiveness. Operations ceased at the end of Fuel Cycle 11 on November 30, 1992. Under the agreement, SONGS 1 will be operated and staffed as usual until all fuel is removed from the reactor vessel in late 1993. Thereafter, staffing and support requirements will decrease over the next 2 years to levels appropriate for long-term plant storage. The settlement agreement also allows SCE and SDG&E to recover their remaining capital investments over 4 years (\$110 million for SDG&E and \$350 million for SCE). The previously authorized rate of return applied until Unit 1 was shutdown, and the rate based on long-term debt has applied since shutdown.

All fuel in the SONGS 1 reactor vessel will be stored in its spent fuel pool. To provide sufficient

space for this full core offload, 49 fuel assemblies now in the Unit 1 pool will be transferred to the Units 2 and 3 pools. The SONGS site is licensed for such fuel transfers between pools. Current plans are to restrict all fuel storage to onsite pools, but dry storage facilities may be considered in the future to expand storage capacity. After fuel removal, Unit 1 will remain in a long-term shutdown mode. SCE has identified the systems that will remain operable and those that will not. The operable systems will primarily ensure the safe storage of fuel in the pool.

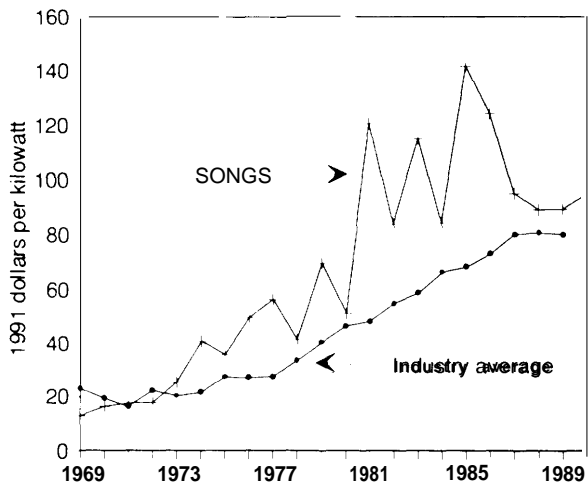
Overall, SONGS performance is consistent with industry averages. Despite earlier difficulties with Unit 1, final operations continued for 377 days. Total plant O&M costs are slightly higher than average, a result of the higher cost of living and thus higher salaries in southern California (figure 5-8). In addition, costs were higher than normal when Units 2 and 3 first came on line.

Federal Energy Regulatory Commission (FERC) data on SCE capital additions provide little information. From 1975 through 1983, capital costs were significantly greater than average, reflecting Unit 1 upgrades. Since then, FERC data indicate below average costs for SCE (figure 5-9). Aside from these FERC data, SCE forecasts capital expenditures on a 5-year basis. Projected costs for the next 5 years range from a low of \$47 per kilowatt-installed to a high of \$62 per

<sup>21</sup> Robert M. Kinoshian, Regulatory Program Specialist, Division of Ratepayer Advocates, California Public Utilities Commission, memorandum to the Office of Technology Assessment, Feb. 8, 1993.



**Figure 5-8-Southern California Edison (SONGS) Non-Fuel Operation and Maintenance Costs (1991 dollars per kilowatt)**



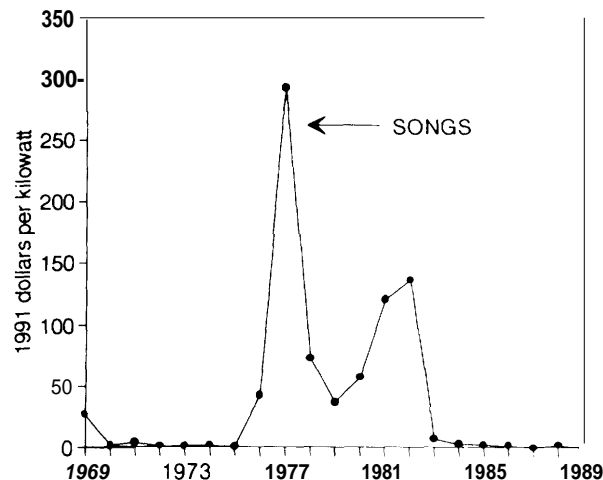
SOURCE: ABZ, Inc. "Case Studies of Nine Operating Nuclear Power Plants: Life Attainment, License Renewal and Decommissioning," contractor report prepared for the Office of Technology Assessment, February 1993.

kilowatt-installed (in year of expenditure dollars). These estimates include overhead costs.<sup>22</sup>

SCE's performance indicators show no distinct weaknesses or noteworthy trends. In response to issues related to design basis documentation, SCE has instituted a comprehensive program to prevent future problems (discussed in the next section). SCE's performance indicators are listed in table 5-18. Events rated as significant by the NRC in the last 5 years are summarized in table 5-19. Compared to other region IV licensees, though, SCE continues to perform well; the utility's SALP scores are listed in table 5-20.

SCE employs a total of 3,500 people for the 3 units, about 2,400 of which are permanent staff. About 2,300 employees are located at the plant site, and the remainder work at headquarters. The site employees are roughly divided as follows: Security (234), Outage Management (36), Main-

**Figure 5-9--Southern California Edison (SONGS) Capital Additions (1991 dollars per kilowatt)**



SOURCE: ABZ, Inc. "Case Studies of Nine Operating Nuclear Power Plants: Life Attainment, License Renewal and Decommissioning," contractor report prepared for the Office of Technology Assessment, February 1993.

tenance (594), Operations (292), Emergency Preparedness (104), Training (137), Technical (165), Chemistry (65), Health Physics (272), and Site Support (326). According to SCE, staff size peaked when Units 2 and 3 came on line but has been decreasing ever since.

### ■ Life Attainment and License Renewal

SCE has two active programs applicable to both life attainment and license renewal: the Current License Basis Program and the Design Bases Documentation and Reconstitution Program. SCE is one of two utilities that has volunteered to participate in an NRC pilot program to develop current licensing bases. The nascent program is first gathering the necessary documentation and investigating methods for future computer retrieval. Anticipated meetings with the NRC will help better define the requirements of the program and develop schedules. SCE

<sup>22</sup> Recent correspondence between SCE and CPUC suggests that SCE has raised capital additions cost estimates for SONGS 2 and 3 to about \$70 per kilowatt. Robert M. Kinoshian, Regulatory Program Specialist, Division of Ratepayer Advocates, California Public Utilities Commission, memorandum to the Office of Technology Assessment, Feb. 8, 1993.

**Table 5-1 8—Performance Indicators for SONGS**

|   | 1985  | 1986  | 1987  | 1988  | 1989  | 1990  | 1991  |
|---|-------|-------|-------|-------|-------|-------|-------|
| Total scrams. . . . .                         | 14    | 14    | 4     | 0     | 3     | 3     | 3     |
| Scrams > 15% per 1,000 hours. . . . .         | 0.74  | 0.56  | 0.16  | 0     | 0.13  | 0.13  | .012  |
| Scrams < 15% per 1,000 hours. . . . .         | 0.17  | 0.33  | 0     | 0     | 0     | 0     | 0     |
| Safety system actuations. . . . .             | 4     | 1     | 1     | 1     | 2     | 1     | 0     |
| Significant events. . . . .                   | 2     | 4     | 2     | 4     | 2     | 0     | 0     |
| Safety system failures. . . . .               | 0     | 2     | 1     | 13    | 9     | 4     | 5     |
| Forced outage rates. . . . .                  | 6.3   | 10.2  | 2     | 1.9   | 18.7  | 2.8   | 8.5   |
| Equipment forced out per 1,000 hours. . . . . | 0.53  | 0.74  | 0.24  | 0.08  | 0.95  | 0.17  | 0.29  |
| Critical hours. . . . .                       | 4,708 | 5,624 | 7,134 | 6,012 | 5,687 | 6,051 | 6,568 |

SOURCE: ABZ, Inc., "Case Studies of Nine Operating Nuclear Power Plants: Life Attainment, License Renewal and Decommissioning," contractor report prepared for the Office of Technology Assessment, February 1993.

expects to complete the development of the licensing basis by June 1993 with a budget of about \$400,000.

SCE's San Onofre Design Bases Documentation and Reconstitution program is designed to retrieve, reconstruct, confirm, and document SONGS's nuclear power plant design bases in a series of Design Bases Documents. The SCE Design Bases Documentation (DBD) Program will document the meaningful plant design bases and ensure prompt access to the associated information. The purpose is to record plant design at the time the operating license was issued, as well as any subsequent design modifications. The program will document the original design bases to help compare their consistency with existing design details. SCE operating, maintenance, and engineering staffs will have access to the information.

With the shutdown of SONGS 1, the program applies only to Units 2 and 3. Although the program is not specifically designed to extend the licensing of Units 2 and 3, its completion would ease any effort to extend either plant license. The DBDs will support a variety of engineering, licensing, and plant operations activities. The scope of the DBD Program includes systems considered important to plant safety, systems with safety-related functions, and select nonsafety-related systems. Systems covered in the plant Technical Specifications are also included.

**Table 5-1 9-Summary of Significant Events at SONGS**

| Unit            | Date      | Description  |
|-----------------|-----------|--|
| Unit 1. . . . . | 12/1 2/88 | 195 steam generator tubes may not have been hard rolled, creating the potential for their disconnection from the tube sheet in the event of a steam line break accident.   |
| Unit 1. . . . . | 12/1 2/88 | An electrical design deficiency could cause a non-class 1 E swing bus not to load shed on a diesel generator start with an SI signal present. A single failure could cause loss of a diesel generator, because a diesel would be required to operate above its T/S rating. |
| Unit 2. . . . . | 12/1 5/88 | 19 valves in the CCW system may fail during a seismic event, which would render the CCW system inoperable.   |
| Unit 3. . . . . | 12/1 5/88 | 19 valves in the CCW system may fail during a seismic event, which would render the CCW system inoperable,   |
| Unit 1. . . . . | 2/2/89    | Fasteners on thermal shield support blocks were found broken. Event date unknown.  |
| Unit 1. . . . . | 3/2/89    | A design deficiency was found in the EDG load sequence logic.  |

SOURCE: ABZ, Inc., "Case Studies of Nine Operating Nuclear Power Plants: Life Attainment, License Renewal and Decommissioning," contractor report prepared for the Office of Technology Assessment, February 1993.

**Table 5-20-Summary of SONGS SALP Scores**

| Assessment period    | Plant operations | Radiological controls | Maintenance/surveillance | Emergency preparedness | Engineering Security | technical support | Safety assessment/quality verification |
|----------------------|------------------|-----------------------|--------------------------|------------------------|----------------------|-------------------|--|
| 2/90-7-91, . . . . . | 2                | 1                     | 2                        | 1                      | 1                    | 2                 | 2                                      |
| 10/88-1/90. . . . .  | 2                | 1                     | 1                        | 1                      | 1                    | 2                 | 2                                      |
| 10187-9188. . . . .  | 1                | 1                     | 2                        | 1                      | 1                    | 3                 | 3                                      |

| Assessment period   | Plant operations | Radiological controls | Maintenance | Surveillance | Fire protection | Emergency preparedness | Security | Outages | Quality programs and administrative controls effecting quality | Licensing activities | Training and qualification effectiveness |
|---------------------|------------------|-----------------------|-------------|--------------|-----------------|------------------------|----------|---------|--|----------------------|--|
| 6/66-9/87. . . . .  | 1                | 2                     | 2           | 2            | 2               | 1                      | 2        | 1       | 2  | 2                    | 1  |
| 10184-5/86. . . . . | 2                | 1                     | 2           | 2            | 1               | 2                      | 2        | 1       | 2  | 2                    | 2  |
| 6/83-9/84. . . . .  | 3                | 3                     | 2           | 2            | 2               | 1                      | 2        | 2       | N  | 2                    | N  |
| 7181-5/83. . . . .  | 2                | 2                     | 2           | 2            | 2               | 1                      | 2        | 1       | 2  | 2                    | N  |
| 6/80-6/81. . . . .  | 2                | 3                     | 3           | 1            | 2               | 1                      | 3        | 1       | 2  | N                    | N  |

NOTE: Category 1 indicates superior performance, where reduced NRC attention may be appropriate; Category 2 indicates good performance and a recommendation to maintain normal NRC attention; Category 3 indicates acceptable performance, where NRC may consider increased inspections, and Category N indicates insufficient information to support an assessment. As these categories suggest, the NRC SALP rankings include no failing grades.

SOURCE: ABZ, Inc., "Case Studies of Nine Operating Nuclear Power Plants; Life Attainment, License Renewal and Decommissioning," contractor report prepared for the Office of Technology Assessment, February 1993.

In general, the contents of self-contained documents are not duplicated in the DBD. Rather, these documents are incorporated by reference, when applicable. Examples of self-contained documents include:

- ASME Code Stress Reports.
- Equipment Qualification Data Packages.
- Vendor Manuals.
- Operations and Maintenance Procedures.
- Industry Codes and Standards.
- Specifications.
- Design Changes, Calculations.
- Design Detail Drawings.

Select DBDs are validated through a process intended to provide reasonable assurance the DBD is complete, accurate, and consistent with the existing as-designed, as-licensed, as-built, as-operated, as-maintained configuration of the plant. The scope of the validation process is flexible and may vary from selective sampling to comprehensive review of the information, depending on system factors such as importance to safety, history of past problems, complexity, and size.

The process of DBD program validation may include any of the following: walkdowns performed by the DBD Engineer (DBD preparer) during document preparation; supervisory review during DBD preparation stages, which may include evaluation by an Independent Review Engineer (IRE); and an interdisciplinary review performed by technicians from Nuclear Engineering, Nuclear Licensing, Station Technical, and other sections of the nuclear staff independent of the DBD Section. DBD managers will select the method of validation on a case-by-case basis.

## ■ Decommissioning

SONGS Unit 1 is jointly owned by SCE (80 percent undivided interest) and SDG&E (20 percent undivided interest). In a decommissioning report submitted to the NRC on July 24, 1990, SCE calculated its share of the Unit 1 decommissioning costs at \$69.5 million (1986 dollars). This

amount was determined in accordance with the formula for minimum financial assurance in 10 CFR 50.75. The California PUC has authorized SCE to collect \$190 million (1992 dollars) for decommissioning costs based on a site-specific cost estimate.

Because SONGS is located on Federal land, SCE is required to return the site to its original condition ('beach sand' after operation. Therefore, the decommissioning cost estimate is greater than the NRC mandated minimum (which considers radiological decommissioning only). Decommissioning funds are being deposited into an external trust account (currently \$18 million per year). To date, SCE has collected \$175 million. No changes to the estimated decommissioning costs have been made since the decision to shutdown Unit 1 early.

In a decommissioning report submitted to the NRC on July 24, 1990, SDG&E calculated its share of the Unit 1 decommissioning costs at \$17.4 million (1986 dollars). This amount was determined in accordance with the formula in 10 CFR 50.75. As required, SDG&E deposits are made annually into an external trust.

Under current plans, SONGS 1 will be decommissioned by the SAFSTOR method. The shutdown and long-term storage of Unit 1 is planned as four phases. The first phase consisted primarily of preparation for final shutdown and has already been completed. The second phase consists of performing a normal plant shutdown at the end of the current refueling cycle and the removal of the fuel from the reactor vessel to the spent fuel pool. The third phase will prepare the unit for long-term storage until Units 2 and 3 are decommissioned. The fourth phase is decommissioning the unit in accordance with an NRC reviewed and approved decommissioning plan.

## ■ Phase 1: Preparation for Plant Closure

This phase includes the preparation and submittal of license amendments, detailed plans for disposition of SSCs, review and evaluation of

station programs and procedures, and development of plans to reduce regulatory requirements to reflect the unit's defueled condition. These plans were discussed during meetings with the NRC. Information from other prematurely shutdown plants were gathered and analyzed with respect to the unique situation at SONGS 1.

## ■ Phase 2: Shutdown and Plant Closure

The unit was shut down in the second phase. The shutdown occurred on November 30, 1992, at the end of fuel cycle 11. The generator output breakers will be opened and the reactor coolant system will be cooled down to permit disassembly of the reactor vessel. Concurrent with vessel disassembly, 49 fuel assemblies from Unit 1 will be moved to the spent fuel pools at Units 2 and 3 to allow the removal of the cycle 11 core. When this fuel offload is completed, the reactor vessel internals will be reinstalled in the vessel. The vessel head will be placed back on the vessel but not tensioned.

SSCs needed to store the fuel safely will continue to operate in accordance with applicable Technical Specifications. Other important operable systems include radiation monitoring, the emergency diesel generators, radwaste processing, and the fuel handling equipment. The SSCs not required to contain radioactive material will be secured to prevent long-term degradation and the inadvertent spread of contamination. Uncontaminated systems will be secured to minimize occupational hazards. The detailed plans to accomplish these long-term storage activities are in preparation,

Following shutdown, measures will be taken to reduce personnel radiation exposure and ease access to areas that may require monitoring. These measures will include wearing lead blankets for shielding in hot spots and some decontamination. In addition, stored radioactive material such as spent resins and filters will be disposed. If practicable, decontamination by sys-

tem flushing to reduce general radiation will also occur.

Storage plans include periodic monitoring to ensure contaminated SSCs are not degrading. Current plans outline an aggressive program to reduce the need for active storage and monitoring equipment. Ideally, all fuel in the Unit 1 spent fuel pool will move to Units 2 and 3 to eliminate the maintenance of equipment and systems needed to cool and store fuel. In the interim, any SSCs not required for spent fuel storage will be drained, vented, and de-energized. The reactor coolant system will be drained and vented. Some water will remain at low points in the circulating loops and in the reactor vessel but will evaporate with time. The steam generators, residual heat removal pumps, heat exchangers, pressurizer relief tank, and the excess letdown and regenerative heat exchanger will also be drained and vented. The containment sump will be pumped dry.

Electric motors in the containment will be de-energized; remaining oil will be removed to reduce the fire hazard. All remaining fluid supplies to the containment will be isolated and any remaining equipment such as lights secured. The containment vent will be locked open to provide a vent path to the plant stack. The equipment and personnel hatches will be locked and posted. Cathodic protection and periodic inspections necessary to maintain the sphere, which contains the radioactive material, will continue until Units 2 and 3 are decommissioned.

Equipment associated with the turbine generator will be secured. The condenser hotwell will be drained. The feed and condensate systems including the condensate storage tank will be drained and vented enough to prevent accidental flooding. All drains and vents will remain open. All electric motors will be secured by tagging their associated breakers. The generator will be purged of hydrogen and vented. The hydrogen tanks and backup nitrogen bottles will be returned to the vendor. The turbine lube oil system will be drained and cleaned. The lube oil reservoir will be emptied, wiped down, and vented. Any motors containing

oil will be drained. Salvageable equipment (e.g., the turbine generator) may be preserved until a purchaser is found.

Equipment in the reactor auxiliary building needed to maintain boron concentration in the core will be secured. The work includes draining and flushing the piping and pumps in the chemical volume control system, such as the boric acid injection pump and the boric acid tank. The radioactive material in the solid and liquid radwaste systems will be processed, packaged, and either stored onsite or sent to a burial site. The solid and liquid radwaste systems will remain in service during deactivation of potentially radioactive systems. This will permit processing of waste generated when systems are drained. The fuel pool cooling and clean up system will be the last one vented and drained. The solid and liquid radwaste systems, therefore, will probably remain in service for at least 3 or 4 years.

Once all potentially radioactive material has been processed, the solid, liquid, and gaseous radwaste systems will be secured. To reduce the potential for airborne contamination, preventive measures will be taken, such as decontaminating floors, walls, and equipment surfaces. Final radiation surveys of the rooms will be performed and the rooms will be posted. All accesses to the building will be locked and posted. Routine building inspections will be performed, with the frequency depending on ALARA (as low as reasonably achievable) radiation exposure concerns and the anticipated degradation of the equipment.

Once the fuel is transferred to Units 2 and 3, the remaining operable systems will be secured. The component cooling and salt water cooling systems will be drained and vented. The electrical and air supplies will be positively isolated. The spent fuel pool cooling and cleanup systems will also be drained and vented. The water remaining in the pool will be pumped out and processed and the pool will be covered. The fuel handling equipment and associated support systems will be secured. The fuel storage building will be sur-

veyed and posted. All accesses will be locked and posted. Routine inspections will be performed consistent with ALARA and any anticipated degradation.

The labs, offices, and equipment shops in the main building will be maintained as needed to support work during plant storage. Some of the facilities may support work for Units 2 and 3. As a result, the HVAC systems will be maintained for habitability, and lighting, fire protection, water, and sewage systems will be maintained too. Access to the control room, switchgear, and cable spreading rooms will be limited to employees supporting the remaining active systems, such as lighting.

Once the fuel has been removed from Unit 1, round the clock coverage for the plant will probably not be needed. The control room will be secured by de-energizing the control and lighting panels and then locked. Similarly, the cable spreading and switchgear rooms will be deactivated and locked. The diesel generators will be preserved to the extent needed to maintain their commercial value. The fuel oil tanks and associated piping will be drained. Any energized support systems such as starting air and control panels will be secured. The diesel generator rooms will be locked. Finally, ventilation systems for areas containing radioactive material, such as the containment and the reactor auxiliary building, will be aligned to provide a single vent path through the Unit 1 stack. The ventilation system and the stack monitor will remain in service until the unit is decommissioned.

### ■ Phase 3: SAFSTOR

Current plans call for the long-term storage of Unit 1 until Units 2 and 3 are decommissioned. As noted above, routine inspections will be performed consistent with ALARA goals and the anticipated degradation of Unit 1 SSCs. A small staff will perform such inspections routinely and provide maintenance. In addition, this staff will maintain any records required to support eventual

decommissioning, including descriptions of the secured state of the plant such as marked-up drawings, radiation surveys, and records of any spills.

#### ■ Phase 4: Final Site Decommissioning

Under current plans, fourth phase will begin when Units 2 and 3 are decommissioned. As required by NRC decommissioning rules, a Unit 1 decommissioning plan will be submitted within 2 years after plant shutdown; the plan will be updated as needed while Units 2 and 3 remain operating. Given the lengthy storage period (in excess of 20 years), advancements in decommissioning technologies such as decontamination methods and waste volume reduction are likely. As a result, changes to the Unit 1 plan are anticipated. In addition, the decommissioning options for Units 2 and 3 should be consistent with Unit 1 and provide the same level of site restoration.

Units 2 and 3 are owned by SCE (75.05 percent undivided interest), SDG&E (20 percent undivided interest), the City of Anaheim (3.16 percent undivided interest), and the City of Riverside (1.79 percent undivided interest). All four of these owners have provided for decommissioning financial assurance according to the formula in 10

CFR 50.75; all four have established separate external trust funds to collect these monies. Their respective funding shares to decommission units 2 and 3 were outlined in separate reports submitted to the NRC in July 1990 and are the following (1986 dollars): \$78.6 million per unit (SCE), \$21 million per unit (SDG&E), \$3.3 million per unit (City of Anaheim), and \$1.9 million (City of Riverside). In sum, these shares amount to almost \$105 million (1986 dollars) per unit.

The California PUC has authorized SCE to collect \$620 million (1992 dollars) for decommissioning costs (based on a site-specific cost estimate). As mentioned earlier, SCE is required to return the site to “beach sand” condition after operation, because the SONGS units are on Federal land. Therefore, the decommissioning cost estimate is significantly greater than the NRC-mandated minimum, which considers reactor-block decommissioning only. SCE is currently depositing \$18 million per year into its external trust. To date, the utility has collected \$375 million. No revision of the estimated decommissioning cost has been made since the decision to shutdown Unit 1, and no formal evaluation has been performed to evaluate the decommissioning potential impacts on from either premature retirement or license renewal of Units 2 and 3.

# Index

- Accident risk, 5, 12,65,67-69,80  
Accident Sequence Precursor program, 69  
ACE. See Atlantic City Electric Company  
ACRS. See Advisory Committee on Reactor Safeguards  
Administrative Procedures Act, 13,45  
Advisory Committee on Reactor Safeguards, 19,68  
AEA. See Atomic Energy Act of 1954  
AEC. See Atomic Energy Commission  
Age-related degradation unique to license renewal, 16-17, 18,58-59  
Aging.  
    causes and effects, 37-44  
    effects on cost and performance, 93  
    experience with, 6-9  
    degradation 9, 37  
    federal safety policy considerations, 6, 17-20  
    impact of aging on safety goals, 64-69  
    institutional efforts, 11-13, 44-47  
    license expiration and renewal, 13-17,57-59,61  
    management of, 10,47-57  
    maintenance practices, 49-52  
    mechanisms for metals, 38  
    nuclear power plant design, 48-49  
    occupational health impacts, 69-71  
    overview, 10-11  
    public health goals, 61,63-64  
    research, 52-53, 55-57  
ALARA. See As low as is reasonably achievable  
American Nuclear Insurers, 145  
American Society of Mechanical Engineers, 39-40, 48,49, 162  
ANI. See American Nuclear Insurers  
Annealing, reactor pressure vessel **embrittlement** and, 40  
ARDUTLR. See Age-related degradation unique to license renewal  
As low as is reasonably achievable, 64, 140  
ASME. See American Society of Mechanical Engineers  
Atlantic City Electric Company, 156, 165  
Atomic Energy Act of 1954, 11,44,57  
Atomic Energy Commission, 48, **84, 170**  
Atomic Industrial Forum, 135  
Babcock and Wilcox, 16, 149  
Babcock and Wilcox Owners' Group, 16  
**Backfitting** rule, 59,61  
Background radiation, 64-65, 107  
Baltimore Gas and Electric Company, See **Calvert** Cliffs Nuclear Power Plants  
Below regulatory concern, 32, 103, 104-105  
**BG&E**. See Baltimore Gas and Electric Company  
Boiling water reactors  
    collective radiation doses, 139-141  
    cost estimates from decommissioning, 137-138  
    low-level waste, 109, 111  
    recirculation piping aging, 53-54  
BRC. See Below regulatory concern  
**BWOG**. See Babcock and Wilcox Owners' Group  
**BWRs**. See Boiling water reactors  
  
**CAAA**. See Clean Air Act Amendments of 1990  
Cables. See Electrical equipment  
California Public Utilities Commission, 3,26,84,85, 171  
**Calvert** Cliffs Nuclear Power Plants, 39  
    decommissioning, 156  
    life attainment and license renewal, 153-155  
    performance and operating history, 150-153  
    spent fuel storage, 98  
Cancer mortality rates, 65,70-71  
Capacity factors, 84-88,89  
Capacity margins, 76  
Capital additions, 25,89-91  
Carbon dioxide emissions, 22,79  
Case studies  
    **Calvert** Cliffs site, 150-156  
    Hope Creek site, 156-160  
    Monticello site, 160-164  
    Salem site, 165-170  
    San **Onofre** site, 170-178  
**CFs**. See Capacity factors  
Chemical decontamination, 95, 129  
Chernobyl nuclear accident, 67  
CLB. See Current licensing basis



- Clean Air Act Amendments of 1990, 80  
 climate change. See Global climate change  
 Collective radiation doses, 139-141  
 Colorado Public Utilities Commission, 84, 123  
 Combustion Engineering, 149-150  
 Commonwealth Edison Company, 75, 89  
 ConEd. See Consolidated Edison Company of New York  
 Conflation Baseline Documentation Project, 158-159, 167  
 Consolidated Edison Company of New York, 95  
 Corrosion **definition**, 38  
 Critical Mass Energy **Project**, 147  
 Current licensing basis, 11, 58
- DBD**. See **Design Bases Documentation Program**
- D&D**. Decontamination and decommissioning See **Decommissioning**
- Decommissioning**  
 cost estimation, 132-139  
 decontamination and decommissioning, 127, 129-130  
**definition**, 101  
 dismantlement technologies, 130, 132, 133  
 early retirement financial requirements, 141-147  
 federal policy considerations, 6, 33-36  
 financing, 33, 128-129  
 international experience, 125, 127, 130  
 overview, 30-31  
 radiation exposure estimation, 132, 134, 139-141  
 radioactive waste disposal, 108-118  
 residual radioactivity standards, 31-33, 102-108  
 U.S. experience, 118-125
- DECON**, 32, 101, 112, 122, 134, 137, 139-140, 95
- Decantamination** factor, 127, 129
- Delmarva** Power and Light, 165
- Demand-side management, 76-77
- Design Bases Documentation Program, 173, 175
- DF**. See Decontamination factor
- Division of **Ratepayer** Advocates, 3, 84
- DLC**. See **Duquesne Light** Company
- DOE**. See U.S. Department of Energy
- DP&L**. See **Delmarva** Power and Light
- DRA**. See Division of **Ratepayer** Advocates
- DSM**. See Demand-side management
- Duke Power Company, 42
- Duquesne Light** Company, 120
- Early retirements. See *also* **Decommissioning**  
 recent plant closures, 3-4
- Economic incentive programs, 84-86
- Economic issues  
 aging issues, 24-25  
 changing electric utility context, 73-81  
 factors affecting future costs, 92-99  
 federal policy considerations, 6, 27-30  
 institutional roles, 26-27, 81-86  
 overview, **2-4**  
 performance of existing plants, 86-92  
 prospects for existing plants, 20-24
- EDF**. See Electricity de France
- EDG**. See Emergency diesel generator
- EDO**. See Executive Director for Operations
- EIA**. See Energy Information **Administration** project
- Electric Power Research Institute, 29, 44-45, 52, 81  
 Electric industry competition, 76-79  
 Electricity demand and capacity margins, 75-77  
 Electrical equipment, 10, 57, 62  
 Electricity de France, 51
- Embrittlement**  
**definition**, **38**  
 reactor pressure vessels and, **39-40**
- Emergency diesel generator, 39, 51
- Energy Information Administration 76
- Energy Policy Act of 1992, 29, 78, 82, 105
- enhanced participatory **rulemaking**, residual radioactivity standards and, 32, 104-106
- ENTOMB**, 32-33, 34-35, 101-102, 112, 142
- Environmental issues, 22, 79-81
- Environmental qualification of electrical equipment, 10, 57, 62, 162
- Environmental Restoration and Waste Management program, 122, 125
- EPA**. See U.S. Environmental Protection Agency
- EPA Standard: 40 **CFR** 192.12, 106
- FPA Standard: 40 **CFR** Part 261, 116
- EPACT**. See Energy Policy Act of 1992
- Epidemiological** studies, 66
- EPRI**. See Electric Power Research Institute
- EQ**. See Environmental qualification of electrical equipment
- Equipment forced outage rate, 60, 61
- ERWM**. See Environmental Restoration and Waste Management program
- Executive Director for Operations, 46
- Fabrication defects, 38
- Fatigue , 10, 38, 57
- Federal Energy Regulatory Commission, 26, 171
- Federal policy considerations  
 assuring adequate aging safety, 17-20  
 decommissioning, 33-36  
 overview, 6  
 supporting economic decisions, 27-30
- FERC**. See Federal Energy Regulatory Commission
- Fitzpatrick Nuclear Power Plant, 75-76
- Formally Utilized Sites Remedial Action Project, 122
- Fort St. **Vrain** Nuclear Generating Station  
 decommissioning, 123-125  
 early retirement, 3, 84, 40 **CFR** 192.12. See EPA Standard: 40 **CFR** 192.12, 40 **CFR** Part 261, See EPA Standard: 40 **CFR** Part 261
- Foster-Wheeler Energy Corporation, 124
- FSD**. See Full system decontamination
- FSV**. See Fort St. **Vrain** Nuclear Generating Station
- FTOL**. See Full-term Operating License
- Fuel costs, 91-92
- Full system decontamination, **95**
- FUSRAP**. See Formally Utilized Sites Remedial Action Project
- General Atomic Technologies, 84  
 "General Design Criteria for Nuclear Power Plants." See **NRC**  
 Standard: 10 **CFR** Part 50, Appendix A
- General Electric, 149-150
- General Public Utilities Nuclear Corporation, 128

- Generic Safety Issues, 17, 57  
 Global climate change, 22,79  
 GPU. See General Public Utilities Nuclear Corporation  
 Greater-than-Class C, 111  
 GSIs. See Generic Safety Issues  
 GTCC. See Greater-than-Class C
- High-level waste. *See* Spent fuel disposal  
 Historical capital costs, 88-89  
 Hope Creek site  
   decommissioning, 159  
   life attainment and license renewal, 158-159  
   performance and operating history, 156-158  
 Hydropower, 81
- IAEA. See International Atomic Energy Agency  
 ICC. See Illinois Commerce Commission  
 ICRP. See International Commission on Radiological Protection  
 Idaho, 124  
 Idaho National Engineering Laboratory, 124  
 IEEE. See Institute of Electrical and Electronics Engineers  
 IGSCC. See **Intergranular** stress corrosion cracking  
 Illinois Commerce Commission, 89  
 Important to license renewal components, 58, 153  
 Important to power production components, 153  
 Independent spent fuel storage installations, 28,98, 155  
 Individual plant examinations, 68  
 Industrywide Initiative, 81,96  
 INEL. See Idaho National Engineering Laboratory  
 INPO. See Institute of Nuclear Power Operations  
 Inspections, 57  
 Institute of Electrical and Electronics **Engineers**, 62, 162  
 Institute of Nuclear Power Operations  
   description, 45  
   evaluations of operating plants, 53, 57  
   maintenance guidelines, 49-50  
   quantitative indicators of nuclear performance, 60  
 Integrated plant assessment, 16, 59  
 Integrated resource planning, 21, 82-83  
 Intergranular stress corrosion cracking, 38, 152  
 International Atomic Energy Agency, 6, 103  
 International Commission on Radiological Protection, 70  
 LPA. See Integrated plant assessment  
 IPEs. See Individual plant **examinations**  
 IRP. See Integrated resource planning  
 ISFSIs. See Independent spent fuel storage installations  
 ITLR. See Important to license renewal components  
 ITTPP. See Important to power production components
- LCMDATA. See Life-cycle management data  
 Least-cost planning. See Integrated resource planning  
 LERs. See Licensee event reports  
 License renewal  
   aging management, 57-59, 61  
   and aging safety, 13-17, 18-19  
 License termination, 142-143  
 Licensee event reports, 60, 152  
 Life-cycle management data, 155  
 Life-cycle management programs, 6, 8, 153, 167  
 LILCO. See Long Island Lighting Company  
 LIPA. See Long Island Power Authority
- LLRWPA. See Low-Level Radioactive Waste Policy Act  
 LLRWPA. See **Low-Level** Radioactive Waste Policy Amendments Act of 1985  
 LLW. See Low-level waste  
 Long Island Lighting Company, 3, 126  
 Long Island Power Authority, 127  
 Low-Level Radioactive Waste Policy Act, 108-109, 113  
**Low-Level** Radioactive Waste Policy Amendments Act of 1985, 104, 108-109, 113  
**Low-level** waste  
   disposal, 96-99, 108-112  
   mixed waste, 35, 116-117  
   projected volumes, 112-116  
   regulatory policies, 35-36
- MAELU. See Mutual Atomic Energy Liability Underwriters  
 Maintenance rule, 10, 18,49  
 Maintenance **Team** Inspections, 57  
 Mechanical effects of metal aging, 38  
 Metals degradation, 38  
 Minnesota, 23, 98, 164  
 Minnesota Public Service Commission, 98  
 Mixed waste. See **Low-level** waste  
 Monitored retrievable storage facility, 23, 28, 97  
 Monticello Nuclear Power Plant  
   decommissioning, 164  
   life attainment and license renewal, 14, 59, 161-164  
   performance and operating history, 160-161  
 MRS. See Monitored retrievable storage facility  
 Mutual Atomic Energy Liability Underwriters, 145
- National Energy Strategy, 21  
 National Environmental Policy Act, 14  
 National Research Council, 29  
 NDE. See Nondestructive examination methods  
 NDTs. See Nuclear decommissioning trusts  
 NEIL. See Nuclear Electric Insurance Limited  
 NERC. See North American Electric Reliability Council  
 New Jersey, 160  
 New York, 3, 82  
 New York Power Authority, 75-76  
 Niagara Mohawk, 94  
 Nitrogen oxide, 80  
 Nondestructive examination methods, 40,51  
 North American Electric Reliability Council, 74  
 North Anna Nuclear Power Plant, 88,94  
 Northern States Power Company, 23, 98, 160-164. See also  
   Monticello Nuclear Power Plant  
 NPAR program. See Nuclear Plant Aging Research program  
 NRC. See U.S. Nuclear Regulatory Commission  
 NRC Regulatory Guide 1.86, 142  
 NRC Standard: 10 CFR 50.2, 106  
 NRC Standard: 10 CFR 50.46, 142  
 NRC Standard: 10 CFR 50.49, 162  
 NRC Standard: 10 CFR 50.55a(g), 142  
 NRC Standard: 10 CFR 50.75, 144, 146  
 NRC Standard: 10 CFR 60.61, 142  
 NRC Standard: 10 CFR 61.50, 115  
 NRC Standard: 10 CFR Part 50, Appendix A, 48, 58  
 NRC Standard: 10 CFR Part 50.75, 126  
 NSP. See Northern States Power Company  
 Nuclear decommissioning trusts, 147

- Nuclear Electric Insurance Limited, 145
- Nuclear Maintenance Applications Center, 52
- Nuclear Management and Resources Council, 13,44-45, 81
- Nuclear Plant Aging Research program, 20,53,55-57
- Nuclear power plants. *See also* Aging
  - challenges to industry, 1-2
  - costs, 86-92
  - design and aging, 48-49
  - external review of activities, 53, 57
  - license expirations, 15
  - locations, 6, 7
  - policy issues, 2-6
- Nuclear Waste Fund, 23,97
- Nuclear Waste Policy Act of 1982, 23,28,96-97
- Nuclear Waste Technical Review Board, 97
- NUMARC. *See* Nuclear Management and Resources council
- NWF. *See* Nuclear Waste Fund
- NWPA. *See* Nuclear Waste Policy Act
- NYPA. *See* New York Power Authority
  
- Occupational health, 69-71, 140-141
- Office of Civilian Radioactive Waste Management, 97
- O&M. *See* Operation and maintenance costs
- Operation and maintenance costs**, 24,91-92
- Organization of Economic Cooperation and Development, 6
- Other radioactive waste, 110
  
- Pacific Gas and Electric Company, 85
- PDMS. *See* Post **defueling** monitored storage
- Pennsylvania State **Low-Level** Waste Advisory Commission, 20
- Performance indicators
  - Calvert Cliffs site, 152
  - description, 60
  - Hope Creek she, 158
  - Monticello site, 161
  - Salem site, 167
  - San Onofre site, 173
- PGE. *See* Portland General Electric
- PG&E. *See* Pacific Gas and Electric Company
- Philadelphia Electric Company, 94, 127, 165
- PNM. *See* Public Service of New Mexico
- POL. *See* Possession-only license
- Portland General Electric, 4, 82-83, 129
- Possession-only license, 142
- Post-closure costs, 144
- Post **defueling** monitored storage, 128
- PRA. *See* Probabilistic risk assessment
- Prepayment, 146
- Pressurized thermal shock, 38
- Pressurized water reactors
  - collective radiation doses, 139-140
  - cost estimates from decommissioning, 137
  - low-level waste, 109, 111
  - steam generators, 42-43
- Price Anderson Act, 80, 123
- Probabilistic risk assessment, 50-51,68-69
- Production costs, 91-92
- PSCO. *See* Public Service of Colorado
- PSE&G. *See* Public Service Electric and Gas Company
- PTS. *See* Pressurized thermal shock
  
- Public Citizen, 147
- Public health, 61,63-64
- Public opinion, 5, 45-46. *See also* Enhanced participatory **rulemaking**
- Public radiation doses, 64-66
- Public Service** Electric and Gas Company, 85, 156-160, 165-170
- Public Service Company of Colorado, 3,23,84, 123
- Public Service Company of New Mexico, 89
- Public utility commissions, 26, 82, 83, 144
- Public Utility Regulatory Policies Act of 1978,78
- PUCs. *See* Public **utility** commissions
- PURPA. *See* Public Utility Regulatory Policies Act of 1978
- PWRs. *See* Pressurized water **reactors**
  
- Radiation doses
  - estimating for decommissioning, 139-141
  - nuclear power plant workers, 69-71, 140-141
  - public, 64-66
- Radioactive waste. *See* **Low-level** waste; Spent fuel disposal
- Rancho Seco** Nuclear Power Plant
  - early retirement, 3
  - financing decommissioning, 128
- RCM. *See* Reliability-centered maintenance
- Reactor pressure vessels, 38-40
- Recirculation piping, 53-54
- Reference reactors, 137-141
- Reliability-centered maintenance, 50
- Residual radioactivity standards, 31,32, 102-108
- Resource Conservation and Recovery Act of 1976,35
- Restricted use, 32, 107
- Retirement. *See* **Decommissioning**; Early retirement
- RFM. *See* Risk-focused maintenance
- Risk assessment, 66-67
- Risk-focused maintenance, 50-51
- Robotics, 51
- RPVS. *See* Reactor pressure vessels
  
- Sacramento Municipal **Utility** District, 3, 128
- Safety goal policy, 12,20, 63-64
- SAFSTOR, 32, 177-178
- Salem site
  - decommissioning, 169-170
  - life attainment and license renewal, 167-169
  - performance and operating **history**, 165-167
  - spent fuel storage, 169
- SALP. *See* Systematic assessment of licensee performance
- San Diego Gas and Electric Company, 84, 170
- San Onofre Nuclear Generating Station
  - decommissioning, 175-178
  - early retirement, 3-4, 84
  - financing decommissioning, 128
  - life attainment and license renewal, 172-175
  - performance and operating history, 170-172
- Sandia** National Laboratories, 62
- SCE. *See* Southern California Edison Company
- Scrams, 60, 61
- SDMP. *See* Site Decommissioning Management Plan program
- SEP. *See* Systematic Evaluation **Program**
- SGS. *See* Steam **generators**
- Shippingport Nuclear Power Plant, 120-122

- Shoreham Nuclear Power Plant
  - decommissioning, 126-127
  - early retirement, 3
- Site Decommissioning Management Plan program, 122
- SMUD. See Sacramento Municipal Utility District
- SOC. See Statement of considerations
- SONGS, See San Onofre Nuclear Generating Station
- Southern California Edison Company, 3, 84, 170-178
- Spent fuel disposal, 23, 27-28, 96-99, 117-118
- SSCs. See Systems, structures, and components
- Staffing, 91-92
- Standard Review Plan, 48
- Statement of considerations, 16, 59
- Steam Generator Replacement Group, 42
- Steam generators, 42-43
- Sulfur dioxide, 80
- Surety method, 146
- Systematic assessment of licensee performance
  - Calvert Cliffs site, 154
  - description, 24,60
  - Hope Creek site, 157
  - Monticello site, 163
  - Salem site, 168
  - San Onofre site, 174
- Systematic Evaluation Program, 10,49
- Systems, structures, and components, 37-44
  
- 10 CFR 50.2. See NRC Standard: 10 CFR 50.2
- 10 CFR 50.46. See NRC Standard: 10 CFR 50.46
- 10 CFR 50.49. See NRC Standard: 10 CFR 50.49
- 10 CFR 50.55a(g). See NRC Standard: 10 CFR 50.55a(g)
- 10 CFR 50.75. See NRC Standard: 10 CFR 50.75
- 10 CFR 60.61. See NRC Standard: 10 CFR 60.61
- 10 CFR 61.50. See NRC Standard: 10 CFR 61.50
- 10 CFR Part 50, Appendix A. See NRC Standard: 10 CFR Part 50, Appendix A
- 10 CFR Part 50.75. See NRC Standard: 10 CFR Part 50.75
  
- Three Mile Island, 65, 67, 128
- TLG Services, Inc., 159
  
- TMI. See Three Mile Island
- Trojan Nuclear Power Plant
  - early retirement, 4
  - economic analysis, 82-83
  - financing decommissioning, 129
  
- Union of Concerned Scientists, 47
- Unit cost factor, 135
- Unrestricted use, 106-107
- U.S. Department of Energy
  - aging research, 52-53
  - Shippingport decommissioning, 120-122
  - spent fuel disposal, 23, 96-97
- U.S. Environmental Protection Agency, 35, 105
- U.S. Nuclear Regulatory Commission
  - aging research, 52-53, 55-57
  - assuring adequate aging safety, 17-20
  - enhanced participatory rulemaking, 32, 104-106
  - inspection program, 57
  - license renewal rule, 13-14, 16,58-59
  - licensee financial conditions rule, 33
  - maintenance rule, 10, 49
  - public participation in, 19, 20,31-32,45,47
  - safety goal policy, 12, 63-64
  
- Virginia Power, 88, 94
  
- Washington Public Power Supply System, 94
- Waste disposal. See Low-level waste; Spent fuel disposal
- Westinghouse Electric Corporation, 123, 149-150
- Workers. See Occupational health
  
- YAEC. See Yankee Atomic Electric Company
- Yankee Atomic Electric Company, 47, 128
- Yankee Rowe Nuclear Power Plant
  - early retirement, 3, 75
  - financing decommissioning, 128
  - license renewal request, 14, 16
  - public petition, 47